

Q8 Firmware Update Guide

Copyright (C) 2021 ZOOM Corporation. All Rights Reserved.

● ZOOM Corporation will bear no responsibility for any losses or third-party claims resulting from the use of this software. Moreover, distribution, sale, leasing, rental, alteration, and reverse engineering without permission of this software are prohibited. The specifications of this software and the contents of this document could be changed without notice in the future.

- Copying or reprinting this manual in part or in whole without permission is prohibited.
- Windows® is a trademark or registered trademark of Microsoft® Corporation.
- Mac® is a trademark or registered trademark of Apple Inc.
- Other product names, registered trademarks and company names in this document are the property of their respective companies.
- All trademarks and registered trademarks in this document are for identification purposes only and are not intended to infringe on the copyrights of their respective owners.
- Proper display is not possible on grayscale devices.
- The illustrations in these instructions might differ from actual screens.

This guide explains updating the firmware to version 1.10 as an example.

1. Download the firmware update file.

Download the ZIP file that contains the firmware update file from the Q8 download page.



The screenshot shows a product page for the Q8 camera. On the left, there is an image of the camera and a 'VIEW PRODUCT' button. To the right, under the heading 'DOCUMENTS', there are four PDF links: 'Q8 Operation Manual (5 MB pdf)', 'Q8 Compatible SDHC/SDXC Cards (70 KB pdf)', 'ZOOM Product Driver Installation Guide (3 MB pdf)', and 'Q8 Firmware Update Guide (953 KB pdf)'. Below this, under the heading 'SOFTWARE', there are two items: 'Q8 Firmware' (Q8 v1.10_E.zip (Released 04/08/2020)) and 'Q8 WebCam Driver | Windows'. The 'Q8 Firmware' item is highlighted with a red rectangular box.

On Windows

2. Extract the ZIP file.

Select the folder that contains the downloaded ZIP file. Click ① “Compressed Folder Tools” followed by ② “Extract all”. This extracts the ZIP file.

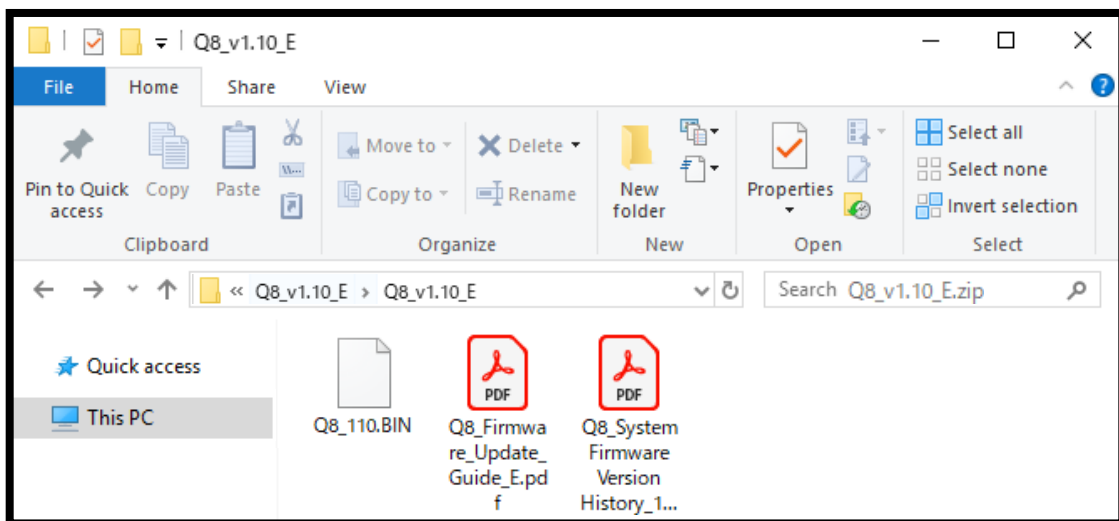
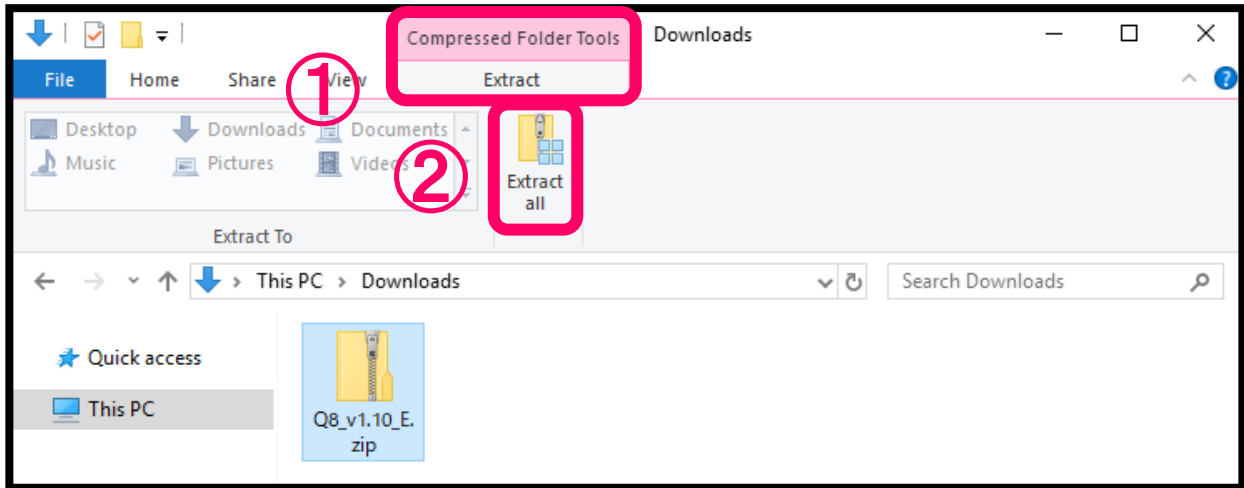

3. Copy the firmware update file to a SD card.
Copy the “Q8_110.BIN” file to a SD card.

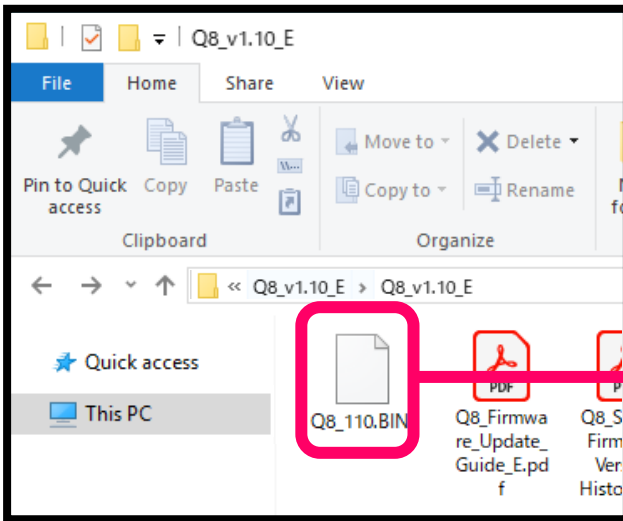

Firmware update file

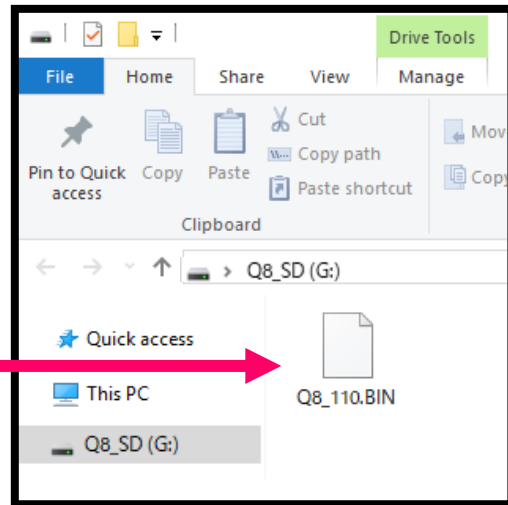

Copy the firmware update file to a SD card.

On macOS

2. Extract the file.

After downloading, open the ① “Downloads” folder, which appears at the right end of the Dock by default. Then, click ②. Downloaded files will be shown.

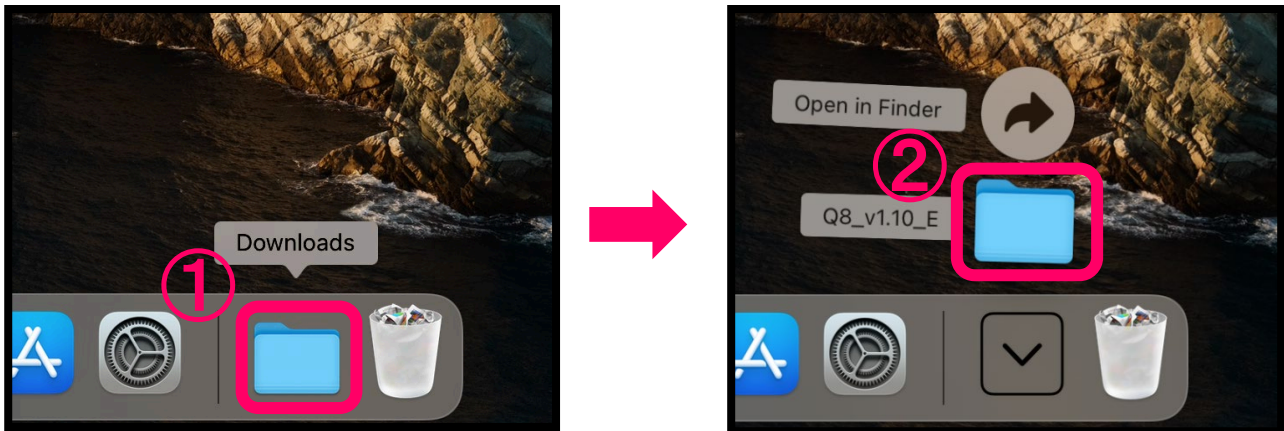

3. Copy the firmware update file to a SD card. Copy the “Q8_110.BIN” file to a SD card.

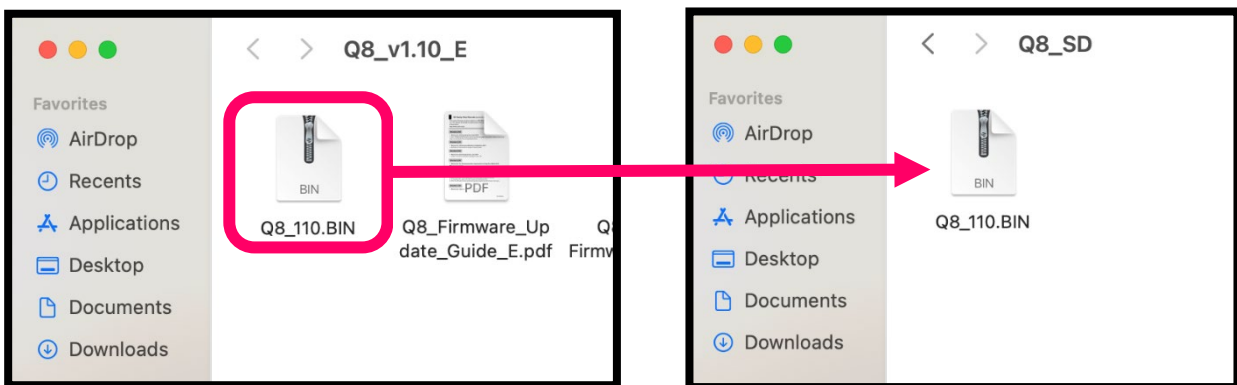

Firmware update file

Copy the firmware update file to a SD card.



The following procedures are the same on both Windows and macOS.

4. Install the fully charged batterie in the Q8 or connect a USB power source.

NOTE

Executing a firmware update is not possible if the remaining battery power is low.

5. Insert the SD card into the Q8 SD card slot.

6. While pressing , press and hold  to turn the power on.

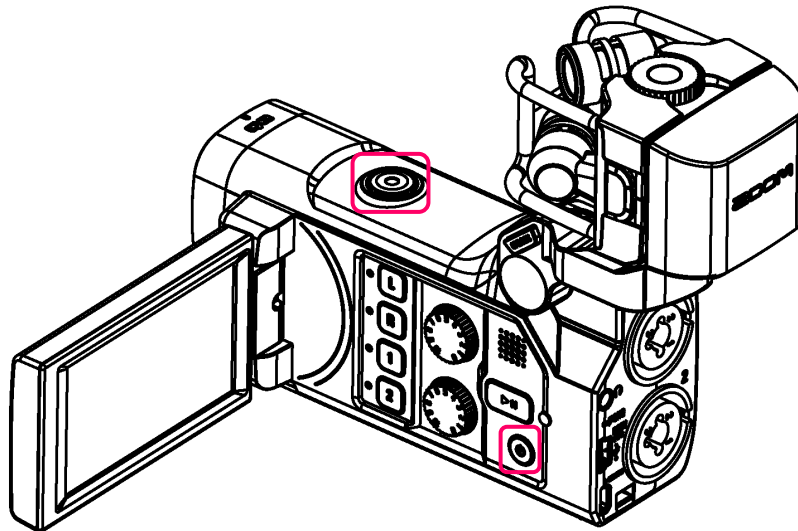

This opens an update confirmation screen.

7. Tap “Yes”.



This opens a final confirmation screen.

8. Tap “Yes”.

After updating, the Completion Screen opens.

NOTE

During the firmware update, do not turn the power off or remove the SD card.

9. After updating, press and hold  to turn the power off.

NOTE

In the unlikely event that a firmware update should fail while in progress, conduct the procedures from the beginning to update the firmware again.

Checking the firmware version

1. On the menu screen, tap .



2. Tap .

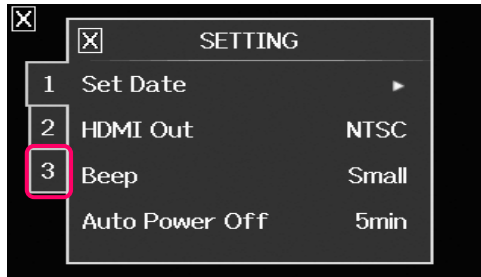

3. Tap "Information".

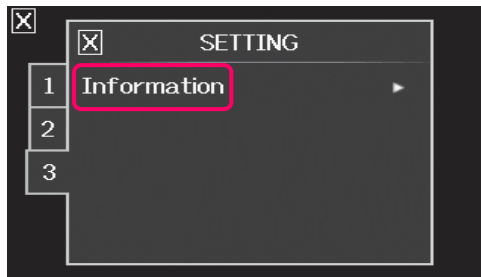

4. Check the firmware version.

