

H6essential

Handy Recorder

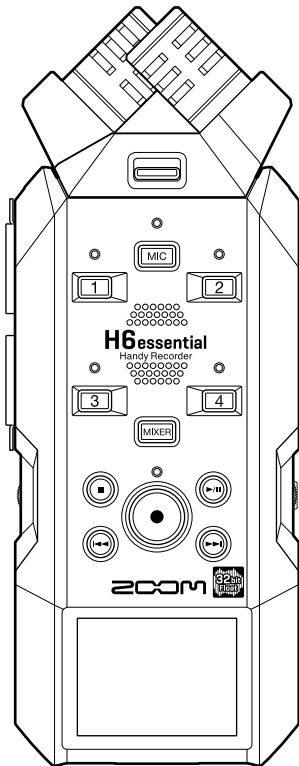

Version 3.30 Supplementary Manual

You must read the Usage and Safety Precautions before use.

©2026 ZOOM CORPORATION

Copying or reprinting this manual in part or in whole without permission is prohibited.

Product names, registered trademarks and company names in this document are the property of their respective companies. All trademarks and registered trademarks in this document are for identification purposes only and are not intended to infringe on the copyrights of their respective owners.

Proper display is not possible on grayscale devices.

Functions added since Version 1.1

■ Features added and changed from Version 3.30

- Function added in Version 3.30

Support for SMPTE timecode input/output using a ZOOM TCA-1 timecode adapter (sold separately) has been added.

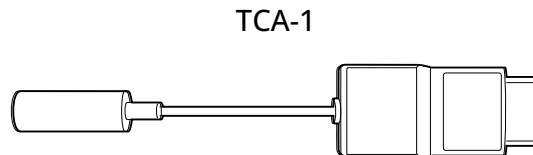

- Function Modified in Version 3.30

The item names in the Bluetooth menu have been changed.

Previous firmware versions

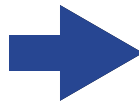
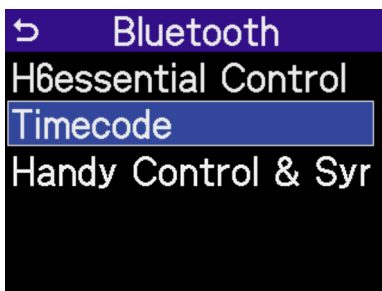

Firmware Ver. 3.30 and later

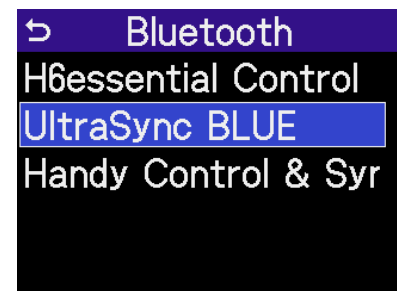

■ Functions added in Version 3.0

- Input gain setting function added
- AI Noise Reduction function added to analyze and reduce environmental sounds and other noise
- Functions added to enable recording and playback of MP3 files
- Functions added to export files in MP3 format
- Mix file recording setting added
- Support for the ZOOM Handy Control & Sync controller application added

■ Functions added in Version 2.0

- Support added for SSH-6e and EXH-6e mic capsules

Support has been added for the SSH-6e and EXH-6e mic capsules, which are sold separately.

- Pause recording function added

A function has been added that enables recording to be paused by pressing the  (PLAY/PAUSE) button.

■ Function added in Version 1.1

- Function added to turn the guide sound on/off with a shortcut

A function has been added that enables the guide sound to be turned on/off immediately by pressing and holding the  (ENTER) button.

Contents

Functions added since Version 1.1.....	2
Functions added in Version 3.30.....	5
Timecode Overview.....	5
Synchronize with external devices using a TCA-1 timecode adapter.....	9
Functions added in Version 3.0.....	31
Setting input gain.....	31
Using AI Noise Reduction.....	34
Recording with MP3 format.....	36
Exporting files in MP3 format.....	37
Setting whether to record mix files.....	40
Operating the H6essential from a smartphone/tablet (ZOOM Handy Control & Sync).....	41
Functions added in Version 2.0.....	44
Using optional mic capsules.....	44
Pausing recording.....	57
Function added in Version 1.1.....	58
Turning guide sounds on/off with a shortcut.....	58
Notes about this manual.....	59

Functions added in Version 3.30

Timecode Overview

Timecode is supplementary time information written into files when recording video or audio. When recording with multiple cameras or recorders, synchronizing the timecode allows editing software to automatically align footage based on the timecode, significantly streamlining synchronization work. The format is represented as "hh:mm:ss:ff" (hours:minutes:seconds:frames).

HINT

The TCA-1 utilizes a high-precision oscillator to generate accurate timecode with an error margin of ± 0.5 frames every 24 hours.

NOTE

- The same frame rate settings must be used by all equipment and all video and audio data.
- The SMPTE timecode standard supports frame rates up to 30 fps. When shooting at high frame rates (60 fps, 59.94 fps, etc.), set the value to half the camera's setting. (→ [Setting the frame rate for the internal timecode](#))

Connection Examples

As examples of timecode connection, we explain two methods: Using an H6essential as the reference and Using an external timecode generator as the reference.

■ Using an H6essential as the reference (synchronizing with a camera)

Use the TCA-1 to output timecode from the H6essential to the camera. By setting the H6essential as the "reference," timecode can be recorded that matches (synchronizes) the audio data from this unit with the video data from the camera.

For this connection, the following modes can be selected: Int Free Run, Int Rec Run, Time of Day (→ [Setting the mode](#))

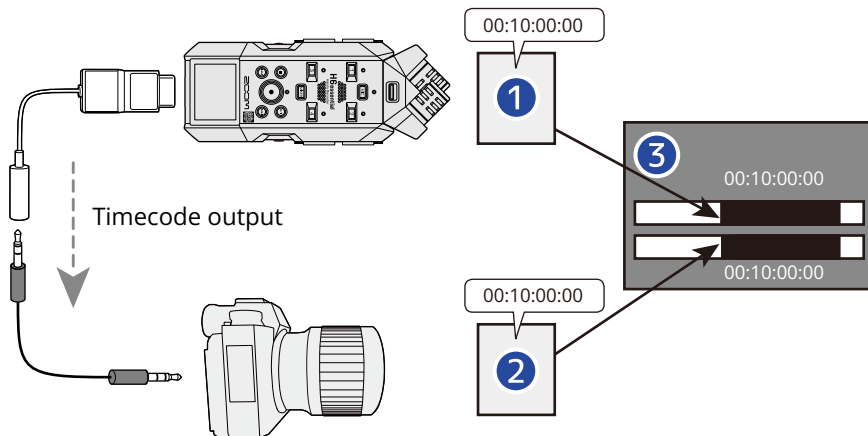

- 1 Recorder**
Records the timecode output by the TCA-1 together with the audio into the file.
- 2 Camera**
Records the received timecode into the file along with the video.
- 3 During Editing**
Video and audio can be synchronized based on the timecode.

■ Synchronization when using a timecode generator or external device as the reference

Connect the TCA-1 to an external timecode generator.

Use the timecode generator as the "reference" to synchronize the H6essential and camera, recording the same timecode to the audio and video.

■ Using in jam mode

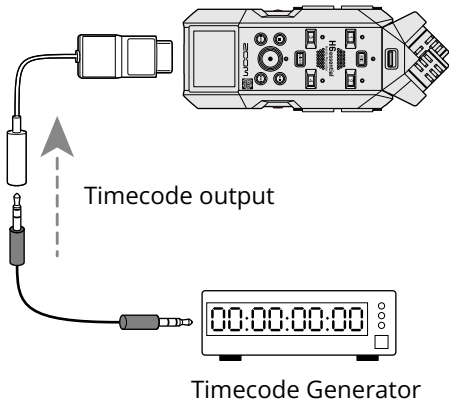

NOTE: No cable needed after jamming

The H6essential receives timecode once from an external timecode generator, synchronizing (jamming) to it. After jamming, the H6essential's clock maintains the timecode even if the connection is disconnected.

- Set the operating mode to match other devices used at the same time.
- The default sync mode is "Int Free Run". In this mode, the timecode continuously advances. Jamming before recording video allows maintaining synchronization across multiple devices. (→ [Setting the mode](#))

HINT

Jamming overview

This function synchronizes the timecode of the connected device with the timecode of the reference device. Jamming matches the H6essential's timecode with the externally input value. Once synchronized, even if the cable is disconnected, the unit will continue counting (running free) using its internal high-precision clock.

■ Using with a constant connection

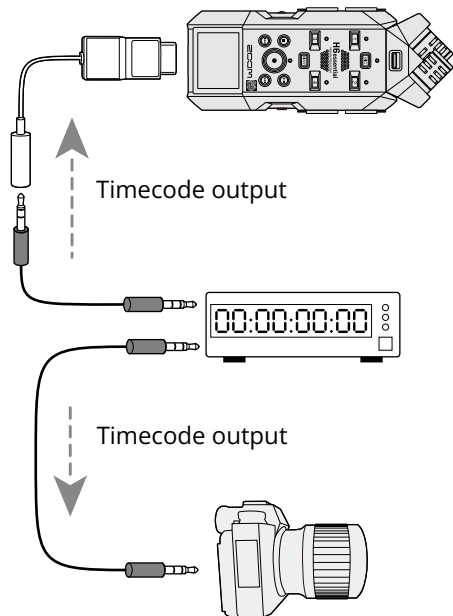

Synchronize by continuously receiving timecode from a timecode generator or similar source. For this connection, you can select the following modes: "Ext" or "Ext Auto Rec". (→ [Setting the mode](#))

Selecting "Ext Auto Rec" automatically starts/stops recording in sync with the external timecode output.

- Use "Auto Rec Delay" to adjust the delay time between receiving the timecode and starting recording. (→ [Setting the delay time for automatic timecode recording](#))
- The behavior when timecode output is interrupted can be selected using the "Ext Continuous" setting. (→ [Making internal timecode run on its own when external timecode input is lost](#))



Synchronize with external devices using a TCA-1 timecode adapter

Connecting the TCA-1 to the H6essential

1. With the H6essential powered off, remove the cover from the REMOTE terminal on the front panel and connect the TCA-1.

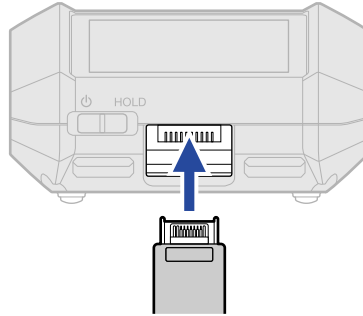
Ensure the side with the visible terminals is facing up.

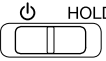

2. Slide the  (Power/HOLD) switch toward the  (INPUT 1/INPUT 3 jacks) until the power turns on, activating the display.

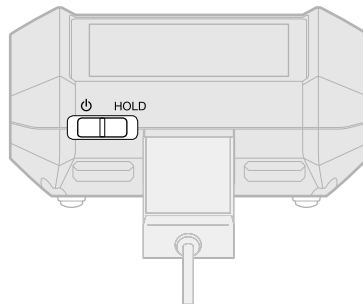

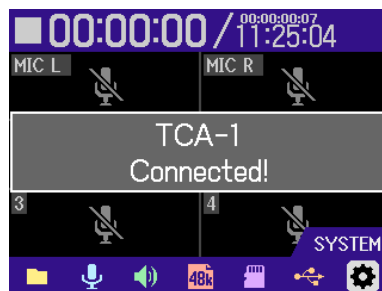

Confirm that "TCA-1 Connected!" is shown.



Setting the mode



The following settings can be made, for example.

- Outputting timecode from the TCA-1 and inputting timecode from an external source
- Enable/disable timecode running independently outside of recording

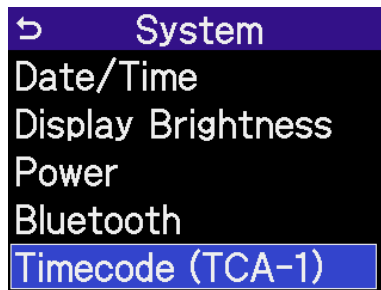

1. On the Home Screen, select  "SYSTEM" using the  (selection) dial and press the  (ENTER) button.
The System Settings Screen will appear.

2. Use the  (selection) dial to select "Timecode (TCA-1)" and press the  (ENTER) button.

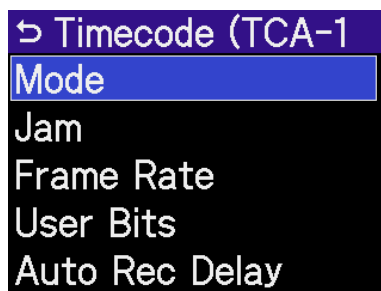

3. Use the  (selection) dial to select "Mode" and press the  (ENTER) button.



4. Use the  (selection) dial to select "On/Off" and press the  (ENTER) button.

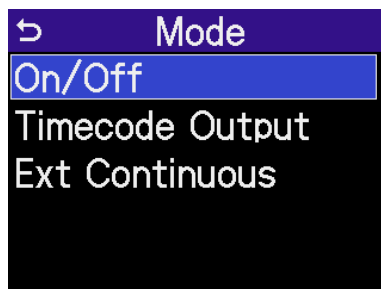

5. Use the  (selection) dial to select the desired setting item and press the  (ENTER) button.

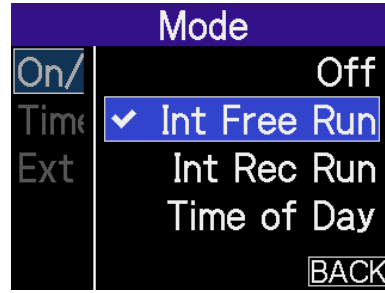



Setting Value	Description
Off	Timecode is not recorded to the recording file. Timecode is not output from the TCA-1.
Int Free Run	<p>The internal timecode continues counting regardless of the recording start/stop state. The start timecode can be set from the following menu items.</p> <ul style="list-style-type: none"> • Jam (→ Jamming the internal timecode) • Restart (→ Restarting the internal timecode at any set value) <p>Timecode output can be switched between "Always" and "Rec Only" using the "Timecode Output" setting.</p>
Int Rec Run	<p>The internal timecode advances only during recording and stops when recording is paused. The start timecode can be set from the following items.</p> <ul style="list-style-type: none"> • Jam (→ Jamming the internal timecode) • Restart (→ Restarting the internal timecode at any set value) <p>After resuming recording, timecode will restart from the value at the time it stopped. Timecode is only output while recording and is not output when stopped.</p>
Time of Day	<p>This mode synchronizes the internal timecode with the H6essential's internal clock (current time). This is applied automatically when this mode is selected or when the H6essential's date/time (Date/Time) is changed.</p> <p>This time-based timecode is continuously output from the TCA-1.</p>
Ext	<p>This mode operates using timecode input from an external device as the reference. When external timecode is input, the internal timecode follows that external signal.</p> <p>The internal timecode can be set to run independently if the external timecode signal is interrupted. (→ Making internal timecode run on its own when external timecode input is lost)</p>

Setting Value	Description
Ext Auto Rec	In addition the functions of Ext mode, this mode automatically switches the recording state using external timecode detection. Recording starts when external timecode input is detected and stops when the external timecode stops.



Outputting timecode only during recording

Whether or not timecode is output from the TCA-1 when the recorder is stopped can be set.

1. On the Home Screen, select  "SYSTEM" using the  (selection) dial and press the  (ENTER) button.
The System Settings Screen will appear.

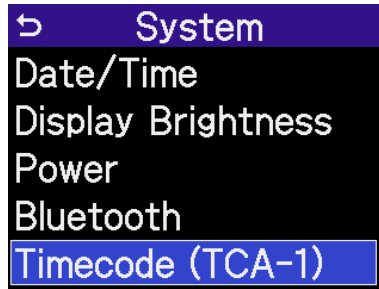
2. Use the  (selection) dial to select "Timecode (TCA-1)" and press the  (ENTER) button.

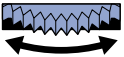

3. Use the  (selection) dial to select "Mode" and press the  (ENTER) button.

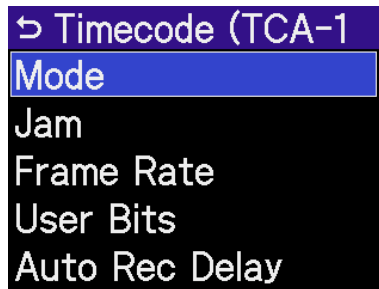

4. Use the  (selection) dial to select "Timecode Output" and press the  (ENTER) button.

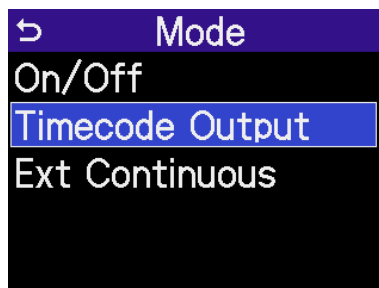

5. Use the  (selection) dial to select "Rec Only" and press the  (ENTER) button.

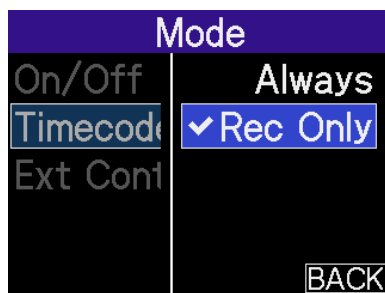



NOTE

Timecode continues to be output when recording is paused.



Making internal timecode run on its own when external timecode input is lost

Internal timecode can be set to run independently to maintain continuity when external timecode is lost.

1. On the Home Screen, select  "SYSTEM" using the  (selection) dial and press the  (ENTER) button.
The System Settings Screen will appear.

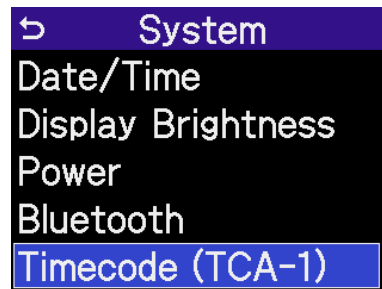
2. Use the  (selection) dial to select "Timecode (TCA-1)" and press the  (ENTER) button.

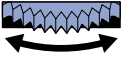

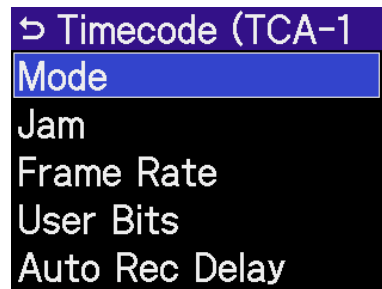

3. Use the  (selection) dial to select "Mode" and press the  (ENTER) button.

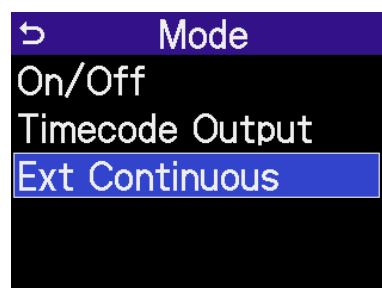

4. Use the  (selection) dial to select "Ext Continuous" and press the  (ENTER) button.



5. Use the  (selection) dial to select "On" and press the  (ENTER) button.

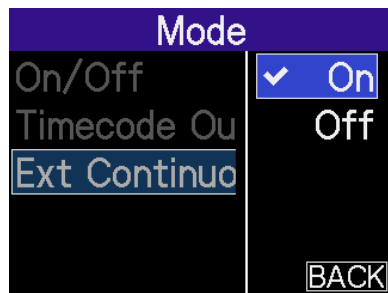



Synchronizing (jamming) the timecode

■ Jamming the internal timecode

You can synchronize the H6essential's internal timecode with the timecode from an external device. After jamming, it will automatically continue counting up (running free) even if the cable is disconnected.

NOTE

First, connect the external device to the TCA-1. Set the mode to "Int Free Run" or "Int Rec Run".

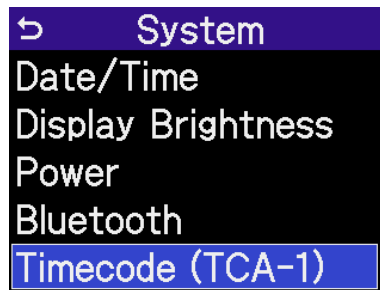

1. On the Home Screen, select  "SYSTEM" using the  (selection) dial and press the  (ENTER) button.
The System Settings Screen will appear.

2. Use the  (selection) dial to select "Timecode (TCA-1)" and press the  (ENTER) button.

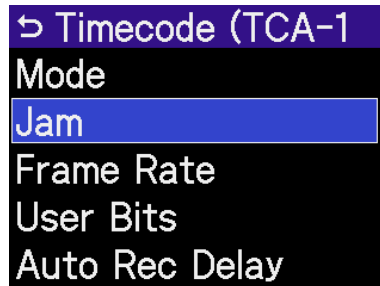

3. Use the  (selection) dial to select "Jam" and press the  (ENTER) button.



4. Use the  (selection) dial to select "Jam" and press the  (ENTER) button.

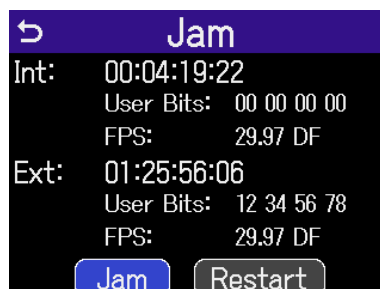



■ Restarting the internal timecode at any set value

The H6essential's internal timecode can be set to any value, and counting up can be resumed from that value.

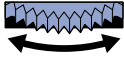

NOTE

Set the mode to "Int Free Run" or "Int Rec Run".

1. On the Home Screen, select  "SYSTEM" using the  (selection) dial and press the  (ENTER) button.
The System Settings Screen will appear.

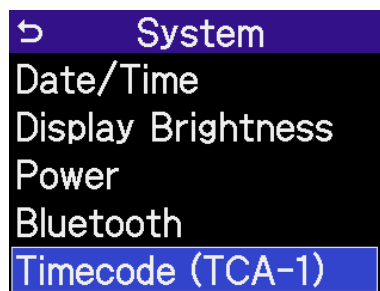
2. Use the  (selection) dial to select "Timecode (TCA-1)" and press the  (ENTER) button.

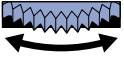

3. Use the  (selection) dial to select "Jam" and press the  (ENTER) button.

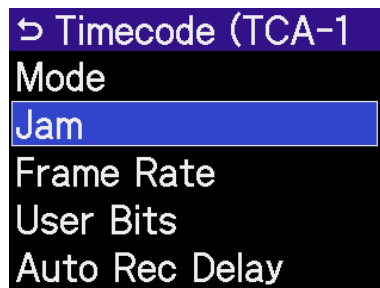

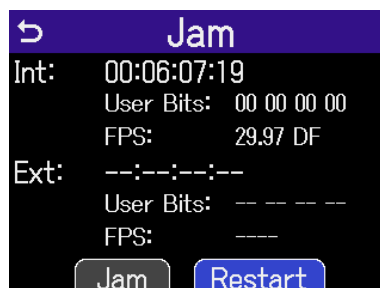

4. Use the  (selection) dial to select "Restart" and press the  (ENTER) button.



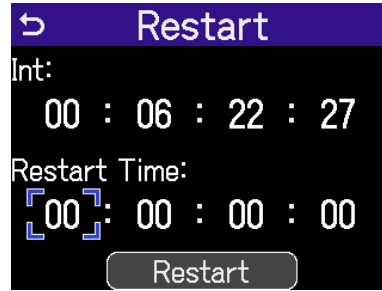

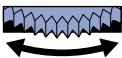
5. Use the  (selection) dial to select the desired setting item and press the  (ENTER) button.

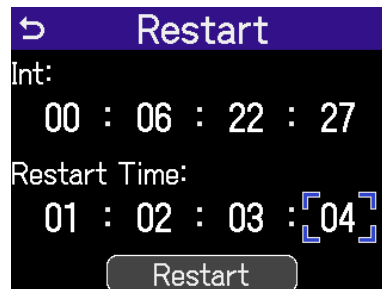

6. Use the  (selection) dial to change the value and press the  (ENTER) button.



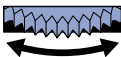

7. Repeat steps 5 and 6 to change all setting values.

8. After setting all values, use the  (selection) dial to select "Restart" and press the  (ENTER) button.



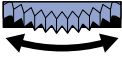

Setting the frame rate for the internal timecode

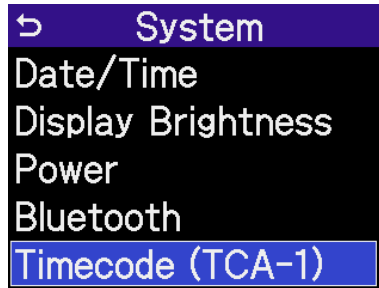

1. On the Home Screen, select  "SYSTEM" using the  (selection) dial and press the  (ENTER) button.
The System Settings Screen will appear.

2. Use the  (selection) dial to select "Timecode (TCA-1)" and press the  (ENTER) button.

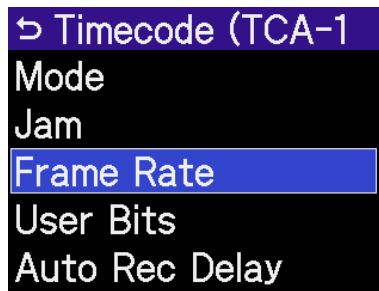

3. Use the  (selection) dial to select "Frame Rate" and press the  (ENTER) button.



4. Use the  (selection) dial to select the frame rate and press the  (ENTER) button.

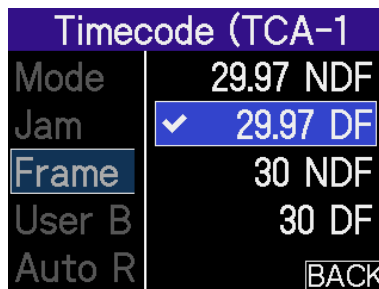

Setting Value	Description
23.976 NDF	This common frame rate is used for high-definition recording, such as with HD cameras. It counts 0.1% slower than real time.
24 NDF	This standard frame rate is used for film shooting and in HD cameras.
25 NDF	This frame rate is for PAL format video, which is used in Europe and other regions.
29.97 NDF	This frame rate is for NTSC color video and HD cameras. It counts 0.1% slower than real time. This is used for NTSC-format video, which is used in Japan, the United States, and other countries.
29.97 DF	This frame rate is adjusted using drop frame timing to match NTSC to the actual time. This is used for broadcast video that requires synchronization with actual time frames.
30 NDF	This is used to synchronize sound to film being transferred to NTSC video. This is the standard frame rate for black-and-white television in Japan, the United States, and other regions.
30 DF	This specialized frame rate is used to synchronize film sound to NTSC using 29.97fps drop frame timing. It counts 0.1% faster than actual time.

NOTE

- Frame rate settings must be the same across all equipment, video data, and audio data used.
- The SMPTE timecode standard supports frame rates up to 30 fps. When shooting at high frame rates (60 fps, 59.94 fps, etc.), set the value to half the camera's recording frame rate.
 - When shooting at 60fps: "30 NDF" or "30 DF"
 - When shooting at 59.94fps: "29.97 NDF" or "29.97 DF"



Setting the User Bits of the Internal Timecode

HINT

Definition of User Bits



"User Bits" refers to an 8-digit data field that can be recorded in the timecode signal, separately from the "Hour:Minute:Second:Frame" time information. Using the digits 0-9 and the letters A-F (hexadecimal), this field can be used to record identifying information such as the shooting date, camera ID, or scene number. This information can be read by video editing software and is useful for organizing footage from multiple cameras or recorders.

■ Setting the user bit mode

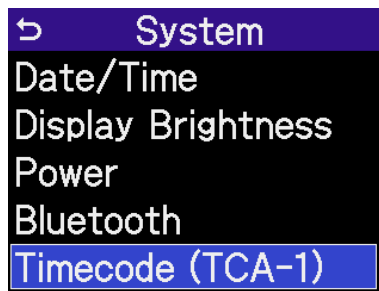

1. On the Home Screen, select  "SYSTEM" using the  (selection) dial and press the  (ENTER) button.
The System Settings Screen will appear.

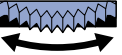
2. Use the  (selection) dial to select "Timecode (TCA-1)" and press the  (ENTER) button.



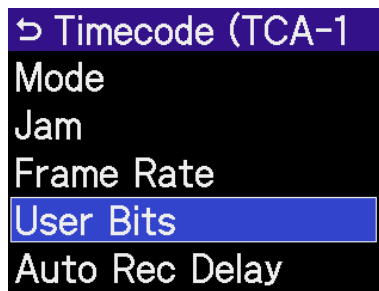

3. Use the  (selection) dial to select "User Bits" and press the  (ENTER) button.

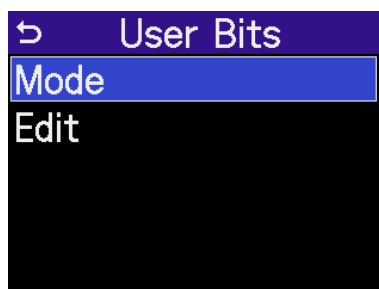

4. Use the  (selection) dial to select "Mode" and press the  (ENTER) button.



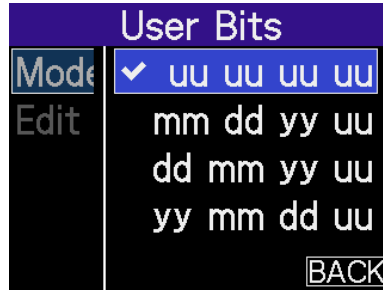

5. Use the  (selection) dial to select the item to set and press the  (ENTER) button.



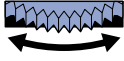

Setting Value	Description
uu uu uu uu	This can be set to any value on the Edit Screen.
mm dd yy uu	The date set in the H6essential is automatically entered in the order of month, day, year, and user bit, which can be set to any value on the Edit Screen.
dd mm yy uu	The date set in the H6essential is automatically entered in the order of day, month, year, and user bit, which can be set to any value in the "edit" screen.
yy mm dd uu	The date set in the H6essential is automatically entered in the order of year, month, day, and user bit, which can be set to any value in the "edit" screen.

■ Setting User Bits

1. On the Home Screen, select  "SYSTEM" using the  (selection) dial and press the  (ENTER) button.
The System Settings Screen will appear.

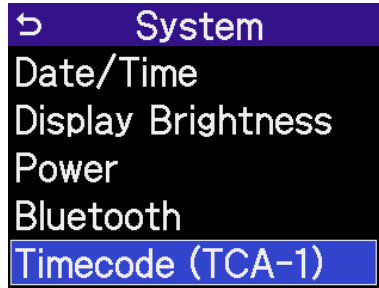
2. Use the  (selection) dial to select "Timecode (TCA-1)" and press the  (ENTER) button.



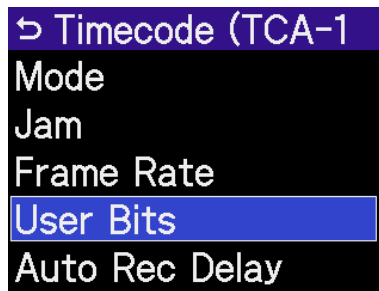

3. Use the  (selection) dial to select "User Bits" and press the  (ENTER) button.



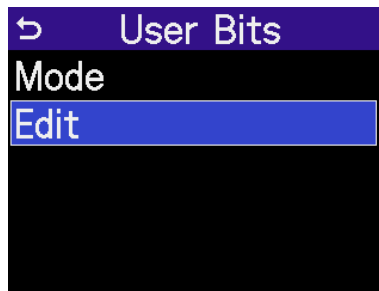

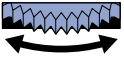
4. Use the  (selection) dial to select "Edit" and press the  (ENTER) button.

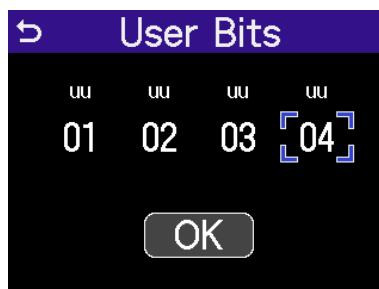

5. Use the  (selection) dial to change the value and press the  (ENTER) button.

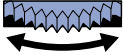

6. After setting all values, use the  (selection) dial to select "OK" and press the  (ENTER) button.

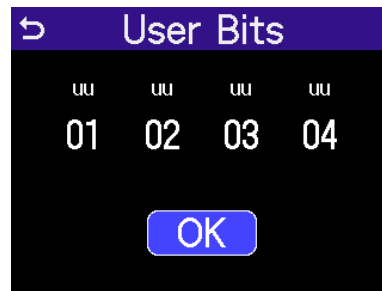

NOTE

Only items set to "uu" in "Mode" can be changed.



HINT

Values can be set within the range 00 to FF.

Setting the delay time for automatic timecode recording

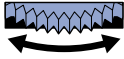

When configured to automatically record upon receiving external timecode, momentary timecode reception may trigger unwanted recordings.

To avoid this, a delay can be set between receiving the timecode and starting recording.

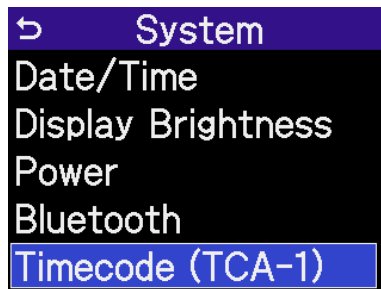

1. On the Home Screen, select  "SYSTEM" using the  (selection) dial and press the  (ENTER) button.
The System Settings Screen will appear.

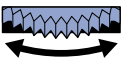
2. Use the  (selection) dial to select "Timecode (TCA-1)" and press the  (ENTER) button.



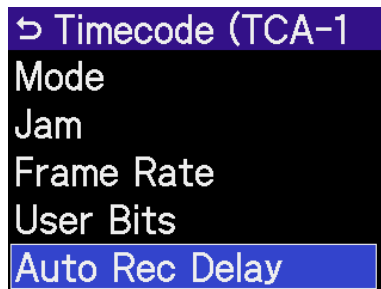

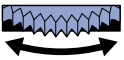
3. Use the  (selection) dial to select "Auto Rec Delay" and press the  (ENTER) button.



4. Use the  (selection) dial to select the value and press the  (ENTER) button.

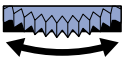

5. Use the  (selection) dial to change the value and press the  (ENTER) button.



6. Use the  (selection) dial to select "OK" and press the  (ENTER) button.





HINT

This can be set in a range from 0.0 to 8.0 seconds.

Changing connector settings to match the connected device

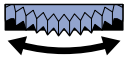
Configure whether the 3.5mm jack connected to the TCA-1 handles signals via the tip or ring to suit the external device.

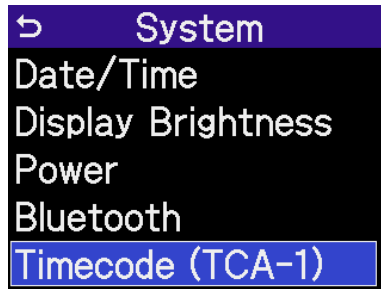

1. On the Home Screen, select  "SYSTEM" using the  (selection) dial and press the  (ENTER) button.
The System Settings Screen will appear.

2. Use the  (selection) dial to select "Timecode (TCA-1)" and press the  (ENTER) button.

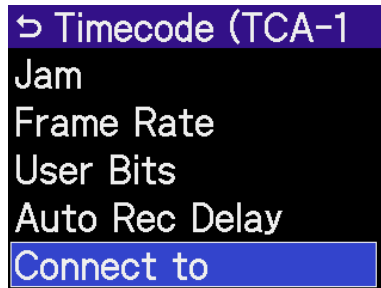

3. Use the  (selection) dial to select "Connect to" and press the  (ENTER) button.

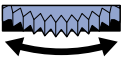

4. Use the  (selection) dial to select the item for the connected device and press the  (ENTER) button.

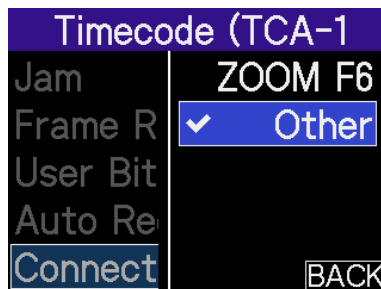

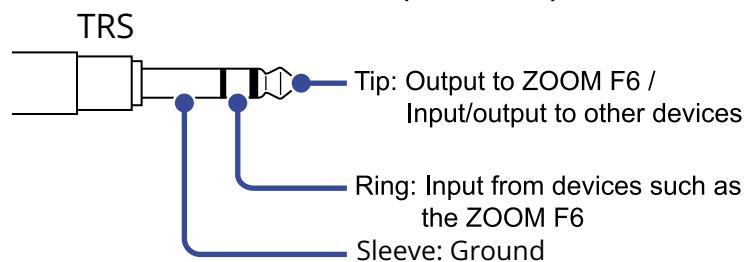

Setting Value	Description
ZOOM F6	<p>This mode assigns the tip for output and the ring for input. Select this when connecting to a ZOOM F6 or another device with similar connector specifications.</p> <p>Signal passing through the tip: This outputs the timecode signal generated by the TCA-1 to external devices.</p> <p>Signal passing through the ring: This inputs the timecode signal generated by an external device into the TCA-1.</p>
Other	<p>This mode handles timecode input/output solely through the tip. On the Jam Screen, the signal passing through the tip switches automatically.</p> <p>Signal passing through the tip:</p> <ul style="list-style-type: none"> • This outputs the timecode signal generated by the TCA-1 to external devices. • This inputs the timecode signal generated by an external device into the TCA-1.

Timecode Input / Output

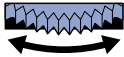

Managing the TCA-1 firmware

■ Checking the firmware version

1. On the Home Screen, select  "SYSTEM" using the  (selection) dial and press the  (ENTER) button.
The System Settings Screen will appear.

2. Use the  (selection) dial to select "Timecode (TCA-1)" and press the  (ENTER) button.

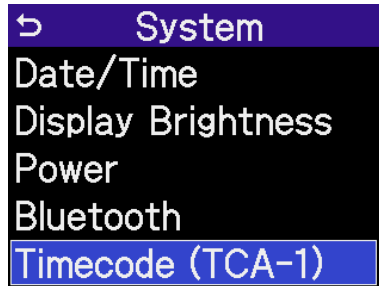

3. Use the  (selection) dial to select "Firmware (TCA-1)" and press the  (ENTER) button.

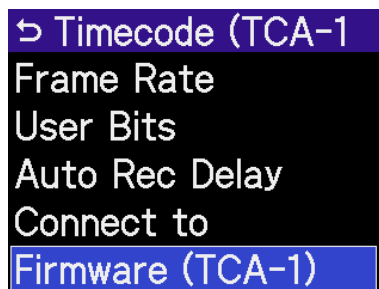

■ Updating the firmware

The TCA-1 firmware can be updated to the latest version.

The latest firmware update file can be downloaded from the ZOOM website (zoomcorp.com/help/tca-1).

Follow the instructions in the "TCA-1 Firmware Update Guide" on the TCA-1 download page.

Functions added in Version 3.0



Setting input gain

Setting input gain for each track on the Mixer Screen

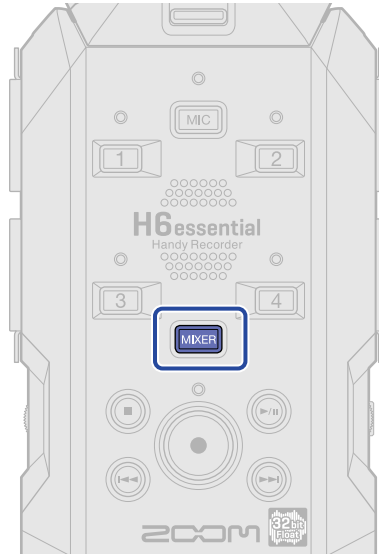

1. Press the  (MIXER) button when the Home Screen is open.

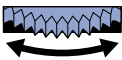

This opens the Mixer Screen.

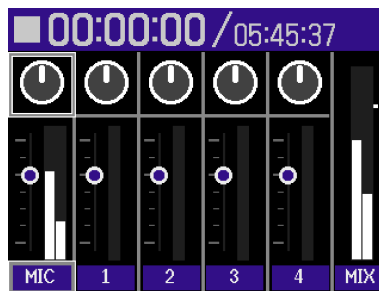
2. Use the  (selection) dial to select the track for gain adjustment and press the  (ENTER) button.



3. Use the  (selection) dial to adjust the gain and press the  (ENTER) button.

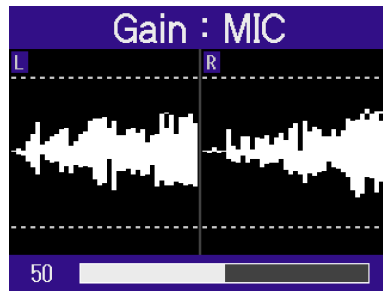

NOTE



When "Format" is set to "MP3", adjust the input gain so that the waveform fits within the dashed lines to prevent clipping in recording files.

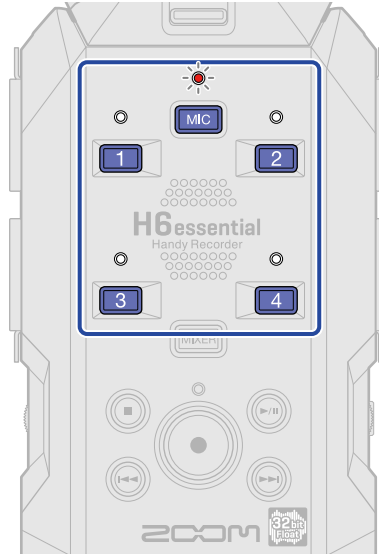

4. Repeat steps 2-3 to adjust the gain of each input.

Setting input gain using a shortcut

1. When the Home Screen is open, press and hold the button of the track for input gain adjustment.

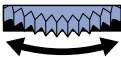

-  : Mic capsule
-  -  : Inputs 1-4

2. Use the  (selection) dial to adjust the gain and press the  (ENTER) button.

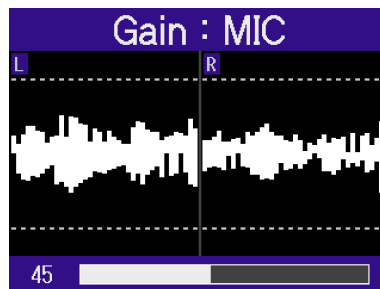





This confirms the gain setting and reopens the Home Screen.

Using AI Noise Reduction

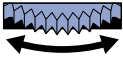

This function can analyze and reduce environmental sounds and other noise.

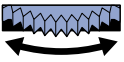
Using the Menu to set AI Noise Reduction

1. On the Home Screen, use the  (selection) dial to select  (REC) and press the  (ENTER) button.
This opens the Rec Settings Screen.

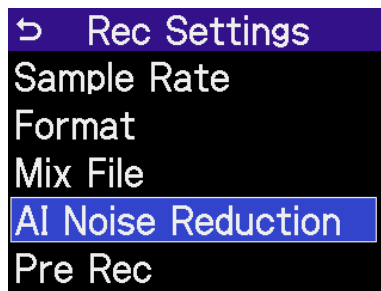
2. Use the  (selection) dial to select "AI Noise Reduction" and press the  (ENTER) button to confirm.

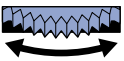

3. Use the  (selection) dial to select the track for AI Noise Reduction activation and press the  (ENTER) button.

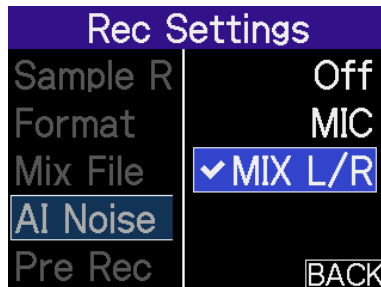

Turning this "ON" will start noise analysis. During analysis (for three seconds) input only environmental sounds and other noise.

Turning this "OFF" will reset the analysis results.

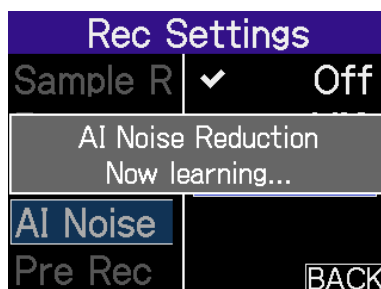

Turning AI Noise Reduction on/off using a shortcut

This function allows AI Noise Reduction to be turned on/off anytime to suit the use situation.

1. When the HOME screen is open, press and hold the  (MIXER) button.

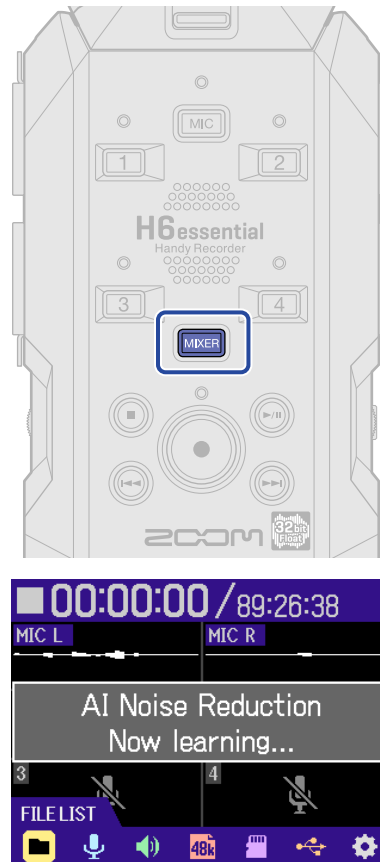

Turning this "ON" will start noise analysis. During analysis (for three seconds) input only environmental sounds and other noise.

Turning this "OFF" will reset the analysis results.



NOTE



- Use the Menu Screen to select the tracks for which AI noise reduction is enabled. (→ [Using AI Noise Reduction](#))
- AI Noise Reduction will always be off at startup.
- When AI Noise Reduction is on, "A" will appear on the Home Screen status icon.



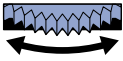

Recording with MP3 format

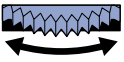
The recording data format can be set to MP3.

1. On the Home Screen, use the  (selection) dial to select  (REC) and press the  (ENTER) button.
This opens the Rec Settings Screen.

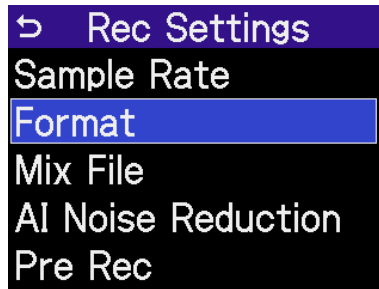
2. Use the  (selection) dial to select "Format" and press the  (ENTER) button to confirm.

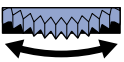

3. Use the  (selection) dial to select the desired setting item and press the  (ENTER) button to confirm.

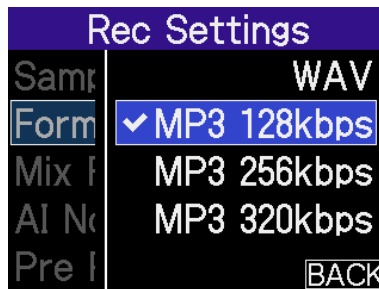

The following formats can be selected.

MP3 128kbps, MP3 256kbps, MP3 320kbps



NOTE

- The sample rate cannot be set to 96 kHz when MP3 is selected.
- Recording with MP3 format is not possible when the sample rate is set to 96 kHz.
- A-B Repeat Playback is supported with MP3 files, but the setting range cannot be saved.

Exporting files in MP3 format



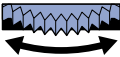

Recorded WAV files can be converted to MP3 and exported.

In addition, recorded files can be normalized to optimize their levels.

1. On the Playback Screen, use the  (selection) dial to select  (EXPORT) and press the  (ENTER) button.

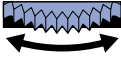

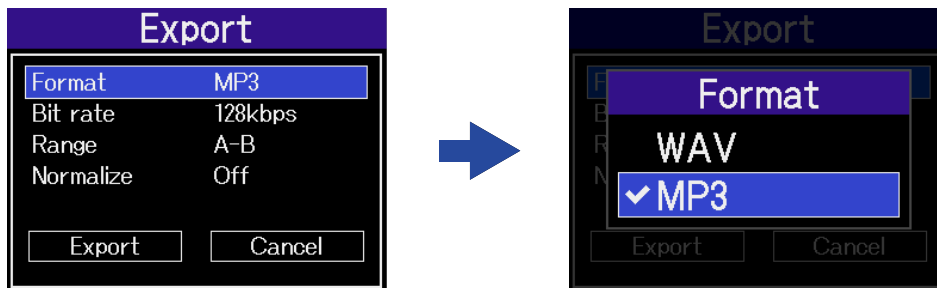

This opens the Export Screen.

2. Select "MP3" for the format.

Use the  (selection) dial to select the format and press the  (ENTER) button. Then, use the  (selection) dial to select "MP3" and press the  (ENTER) button.



3. Select the bit rate.



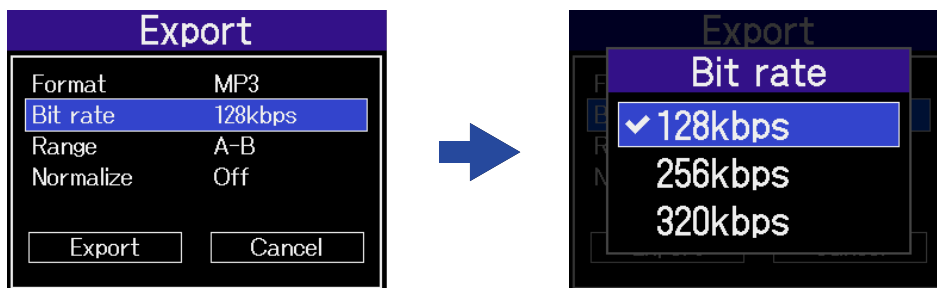

Use the  (selection) dial to select "Bit rate" and press the  (ENTER) button. Then, use the  (selection) dial to select the format and press the  (ENTER) button.



The following formats can be selected.

MP3: 128 kbps, 256 kbps, 320 kbps



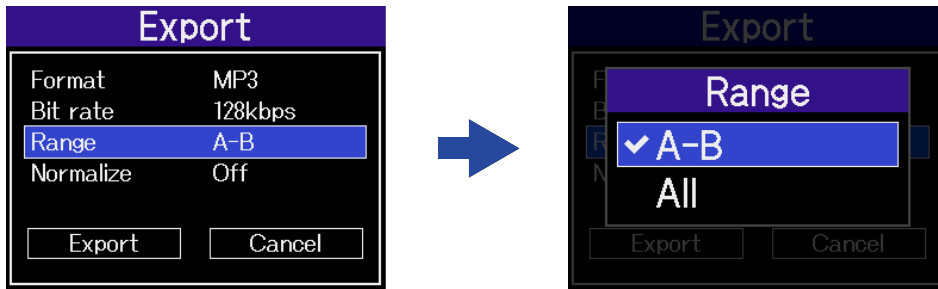

4. Select whether or not to export using a specified range.

Use the  (selection) dial to select "Range" and press the  (ENTER) button. Then, use the  (selection) dial to select the setting and press the  (ENTER) button.



Setting value	Explanation
A-B	This exports the range between the two points set as explained in "Repeat playback of a set interval (A-B repeat)".
All	This exports the entire track.

5. Select whether or not to normalize.

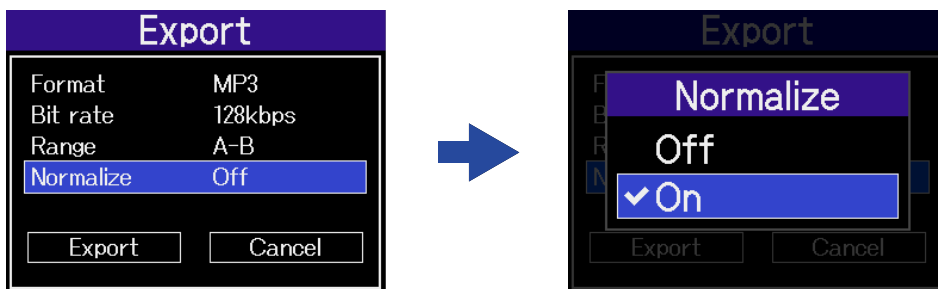

Use the  (selection) dial to select "Normalize" and press the  (ENTER) button. Then, use the  (selection) dial to select "On" or "Off" and press the  (ENTER) button.



If "On" is selected, the file will be normalized during export.

NOTE

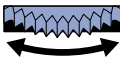
Normalization is a function that reads the maximum level of the audio data and evens out the level without causing distortion. The level is adjusted to the maximum possible without causing the loudest sound (peak) in the data to distort.

When done making all settings, use the  (selection) dial to select "Export" and press the  (ENTER) button.

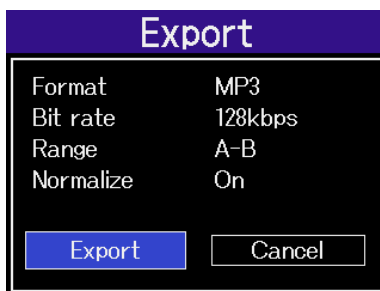

NOTE



MP3 files cannot be exported (as WAV or MP3).



Setting whether to record mix files

In addition to recording each track separately, a stereo mix file of those tracks can also be recorded. The recording of stereo mix files can be disabled to save SD card space.

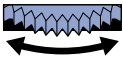

NOTE

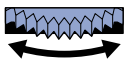
- Even when mix file recording is on, mix files will not be recorded in the following cases.
 - When the sampling rate is 96 kHz
 - When AI Noise Reduction is set to Off or MIC and only one file would otherwise be generated (for example, when only one track or a stereo-linked pair of tracks is being recorded)
- Use the export function to create mixed 96kHz stereo files. (→ Changing formats and exporting files)

1. On the Home Screen, use the  (selection) dial to select  (REC) and press the  (ENTER) button.
This opens the Rec Settings Screen.

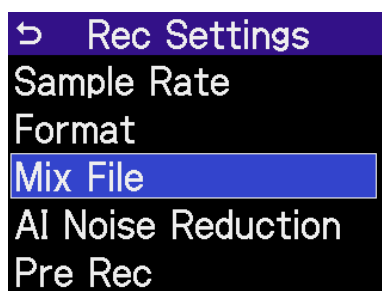
2. Use the  (selection) dial to select "Mix File" and press the  (ENTER) button.

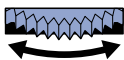

3. Use the  (selection) dial to select "On" or "Off" and press the  (ENTER) button.

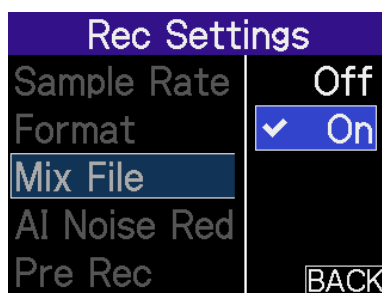

Operating the H6essential from a smartphone/tablet (ZOOM Handy Control & Sync)

The H6essential can be operated wirelessly from a smartphone or tablet by connecting a BTA-1 or another dedicated wireless adapter and using the ZOOM Handy Control & Sync app designed to control it. ZOOM Handy Control & Sync can be connected to multiple recorders and used to simultaneously start and stop recording, synchronize timecode and set the date and time.

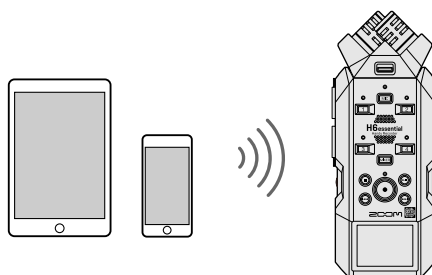



NOTE

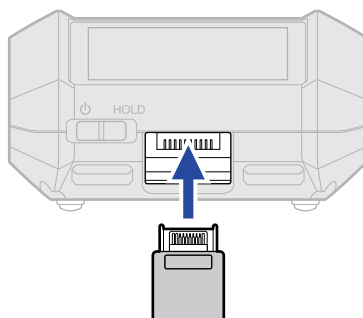

- The ZOOM Handy Control & Sync app must be installed on the smartphone or tablet beforehand. The ZOOM Handy Control & Sync app can be downloaded from the App Store, for example. Refer to the manual for the ZOOM Handy Control & Sync app for details about app settings and operation procedures.
- The H6essential cannot be controlled wirelessly from a smartphone or tablet during audio interface operation (→ Using as an audio interface).
- An H6essential cannot have both ZOOM Handy Control & Sync and an UltraSync BLUE connected at the same time.

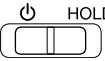
1. With the H6essential power off, remove the REMOTE connector cover on its front. Then, connect a BTA-1 or another dedicated wireless adapter.

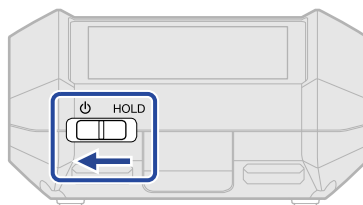

2. Slide the  (POWER/HOLD) switch toward  (in the direction of the INPUT 1 and 3 jacks) until the power turns on and the display becomes active.

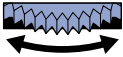

3. On the Home Screen, use the  (selection) dial to select  (SYSTEM) and press the  (ENTER) button.

This opens the System Settings Screen.

4. Use the  (selection) dial to select "Bluetooth" and press the  (ENTER) button.

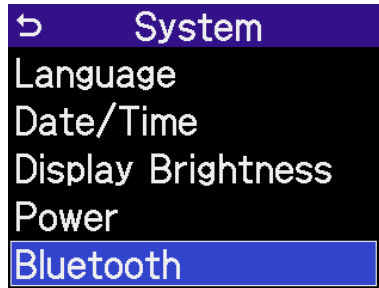

5. Use the  (selection) dial to select "Handy Control & Sync" and press the  (ENTER) button.

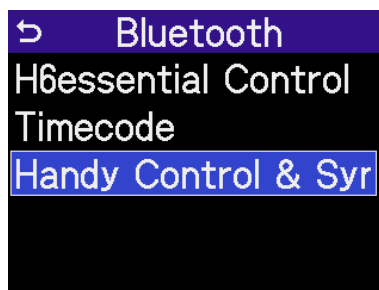

Searching for the device to connect will begin and "Searching..." will appear on the display.



HINT

Searching can be canceled by pressing the  (ENTER) button.

Disconnecting from smartphones and tablets

Disconnection is possible by quitting the app on the smartphone or tablet.

Removing the BTA-1 from the H6essential will also disconnect it from ZOOM Handy Control & Sync.

Functions added in Version 2.0

The mic capsule included with the H6essential can be swapped with a different mic capsule (sold separately) according to recording needs.

The display and operation when using an optional mic capsule are fundamentally the same as when using the included mic capsule. Settings specific to each mic capsule, however, can be changed.

The following optional mic capsules are compatible with the H6essential.

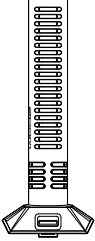
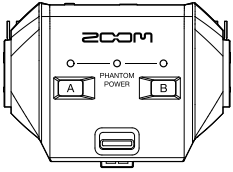
Mic capsule		Explanation
	SSH-6e Shotgun Mic Capsule	Mid-side stereo shotgun mic that supports 32-bit float recording
	EXH-6e External Input	2-channel XLR/TRS input capsule that supports 32-bit float recording

Using optional mic capsules

Using an SSH-6e

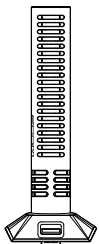

The SSH-6e is a mid-side stereo shotgun mic capsule. Along with a super-directional shotgun mic for capturing sound in the center (mid), it has a bidirectional mic for capturing sound from the left and right (side). The stereo width can be changed freely by adjusting the side level.

NOTE

For details about the SSH-6e, see its manual.



Download the SSH-6e manual from the ZOOM website (zoomcorp.com/help/ssh-6e).

Setting the SSH-6e mode

The operation mode of the SSH-6e can be set.

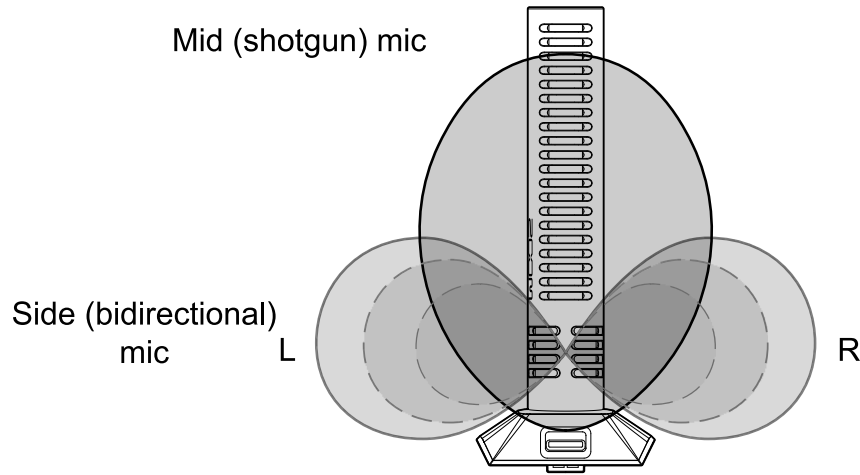

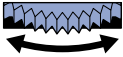
By setting the mode, a wide range of recording styles can be supported, from super-directional mono to stereo, which would normally require using an additional mic.



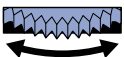

1. On the Home Screen, use the  (selection) dial to select  (INPUT) and press the  (ENTER) button.
This opens the Input Settings Screen.

2. Use the  (selection) dial to select "SSH" and press the  (ENTER) button.

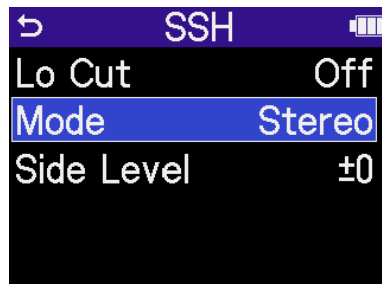

3. Use the  (selection) dial to select "Mode" and press the  (ENTER) button.

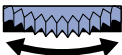

4. Use the  (selection) dial to select the mode to use and press the  (ENTER) button.

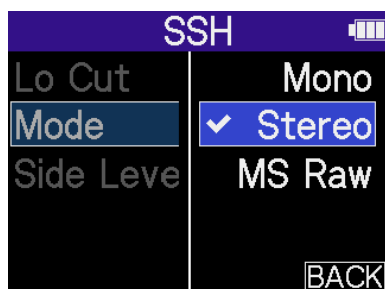



Setting value	Explanation
Mono	This turns off the side mic, enabling use as a mono shotgun mic. This is useful for situations when recording only specific sounds is desired.
Stereo	This uses the mid and side mics together as a stereo shotgun mic that keeps stereo width while having directional focus. This is useful for situations when recording sounds from the surrounding environment is also desired.
MS Raw	The mid mic signal will be recorded to the L channel and the side mic signal will be recorded to the R channel of the stereo file. This function is useful for changing the side level during post-production after recording.

Setting the SSH-6e side level

When using the SSH-6e as a stereo shotgun mic, the side mic level can be set before recording, enabling the stereo width to be adjusted.

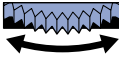

NOTE

Side level can only be adjusted when the SSH-6e mode is set to "Stereo".

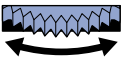

1. On the Home Screen, use the  (selection) dial to select  (INPUT) and press the  (ENTER) button.
This opens the Input Settings Screen.

2. Use the  (selection) dial to select "SSH" and press the  (ENTER) button.



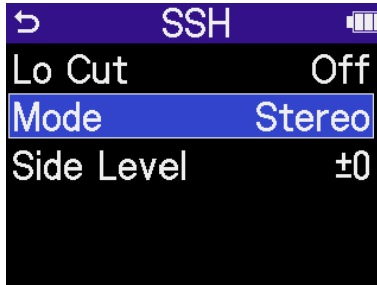

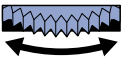
3. Use the  (selection) dial to select "Mode" and press the  (ENTER) button.



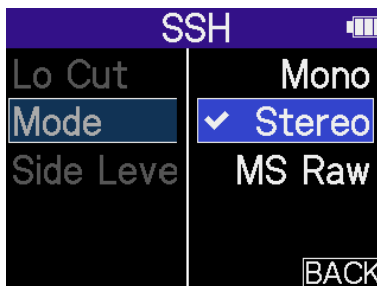

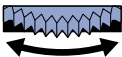
4. Use the  (selection) dial to select "Stereo" and press the  (ENTER) button.



5. Use the  (selection) dial to select "Side Level" and press the  (ENTER) button.

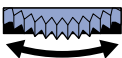



6. Use the  (selection) dial to select the side level and press the  (ENTER) button.



The setting range is -24 to +6. The higher the number is the wider the sound becomes to the left and right.

Reducing noise when using an SSH-6e (Lo Cut)

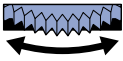

Low frequencies can be cut to reduce the sound of wind and vocal pop noises, for example.

1. On the Home Screen, use the  (selection) dial to select  (INPUT) and press the  (ENTER) button.

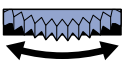

This opens the Input Settings Screen.

2. Use the  (selection) dial to select "SSH" and press the  (ENTER) button.

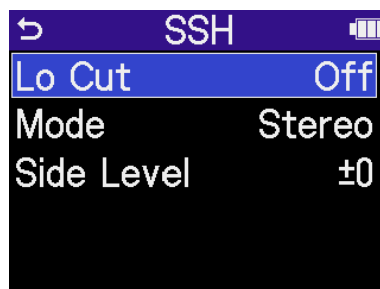

3. Use the  (selection) dial to select "Lo Cut" and press the  (ENTER) button.

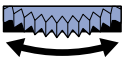

4. Use the  (selection) dial to select the cut-off frequency and press the  (ENTER) button.

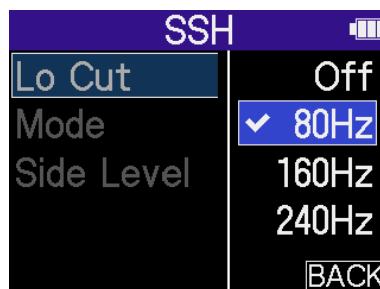

Lo Cut can be set to Off, 80 Hz, 160 Hz or 240 Hz.

Using an EXH-6e

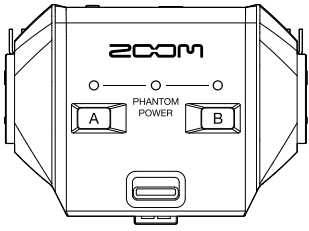

The EXH-6e XLR/TRS combo capsule adds 2 channels of external input. Signals can be input from dynamic mics, line level instruments, mixers and audio players, for example. Phantom power supply is supported, so condenser mics can also be used. In addition, a stereo mini MIC/LINE input jack is built in and supports plug-in power.

NOTE

- When connecting condenser mics and other devices that require phantom power, use an external power supply.

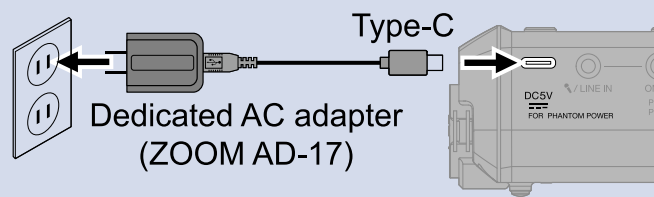

- When connecting a mic that requires plug-in power to the MIC/LINE jack, set the PLUG-IN POWER ON/OFF switch to ON.
- For additional details about the EXH-6e, see its manual.
Download the EXH-6e manual from the ZOOM website (zoomcorp.com/help/exh-6e).

Enabling the EXH-6e inputs

INPUT A and INPUT B of the EXH-6e need to be enabled for use.

1. Press the INPUT A/B button.
This will enable that input jack and light the INPUT A/B status indicator.

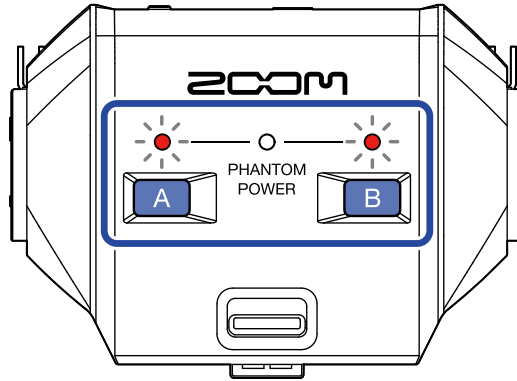

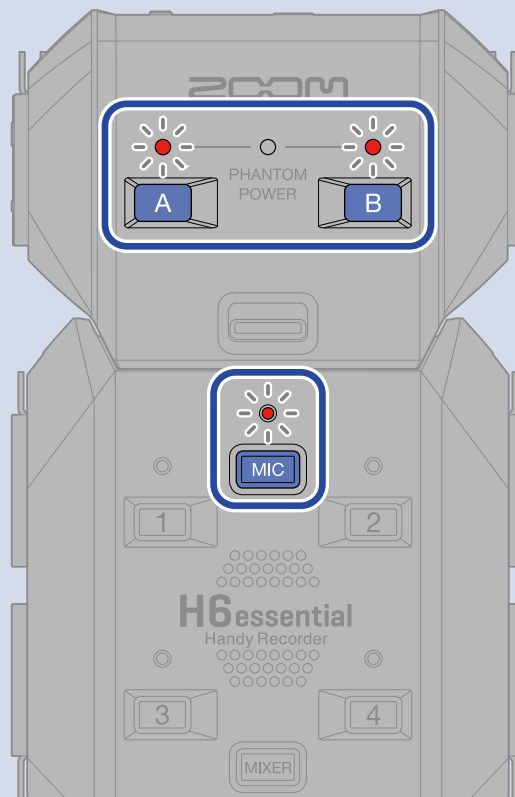

NOTE

To record sound input from an EXH-6e, the mic capsule track must be enabled on the H6essential itself. Confirm that the mic capsule track indicator on the H6essential is lit.



Setting EXH-6e stereo linking

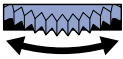

By stereo-linking the EXH-6e inputs, their signals can be handled as stereo audio.

1. On the Home Screen, use the  (selection) dial to select  (INPUT) and press the  (ENTER) button.

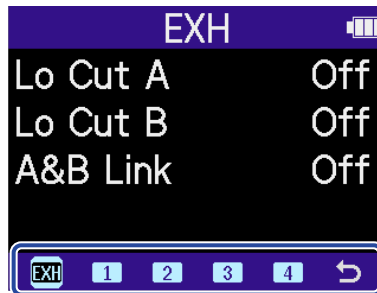

This opens the Input Settings Screen.

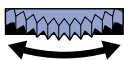
2. Use the  (selection) dial to select "EXH" and press the  (ENTER) button.

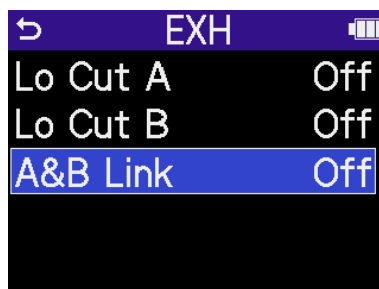

3. Use the  (selection) dial to select "A&B Link" and press the  (ENTER) button.

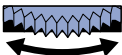

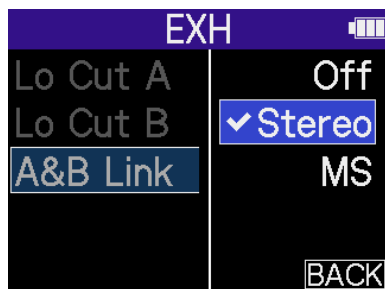

4. Use the  (selection) dial to select the desired item to set and press the  (ENTER) button.





Setting value	Explanation
Off	Input signals will be handled as mono audio.
Stereo	The two EXH-6e input signals will be handled as stereo audio. INPUT A will become the L channel and INPUT B will become the R channel.
MS	The two EXH-6e input signals will be handled as audio captured in mid-side format. INPUT A will be used for the mid signal and INPUT B will be used for the side signal.

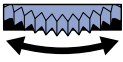

Setting the EXH-6e side level

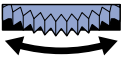
With the EXH-6e, if the input signal is set to “MS”, the side level can be set before recording, allowing the stereo width of the input sound to be adjusted.

1. On the Home Screen, use the  (selection) dial to select  (INPUT) and press the  (ENTER) button.
This opens the Input Settings Screen.

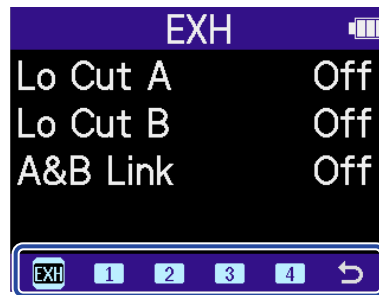
2. Use the  (selection) dial to select “EXH” and press the  (ENTER) button.

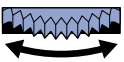

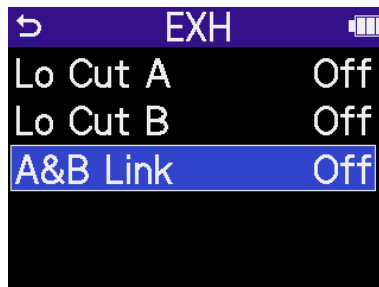

3. Use the  (selection) dial to select “A&B Link” and press the  (ENTER) button.



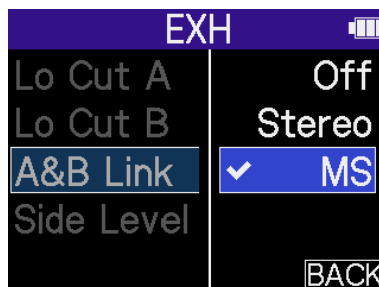

4. Use the  (selection) dial to select “MS” and press the  (ENTER) button.

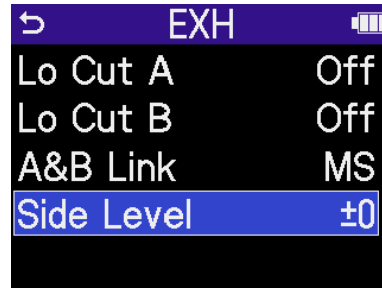

5. Use the  (selection) dial to select "Side Level" and press the  (ENTER) button.



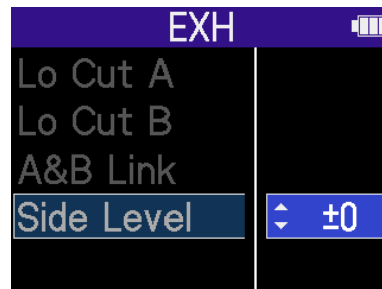

6. Use the  (selection) dial to select the side level and press the  (ENTER) button.



Setting value	Explanation
-24 - +6	The higher the number is the wider the sound becomes to the left and right.
Mute	The side mic will be muted.
Raw	The mid signal will be recorded to the L channel and the side signal will be recorded to the R channel of the stereo file. This setting is useful for changing the side level during post-production after recording.

Reducing noise when using an EXH-6e (Lo Cut)

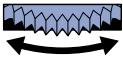
Low frequencies can be cut to reduce the sound of wind and vocal pop noises, for example.

1. On the Home Screen, use the  (selection) dial to select  (INPUT) and press the  (ENTER) button.

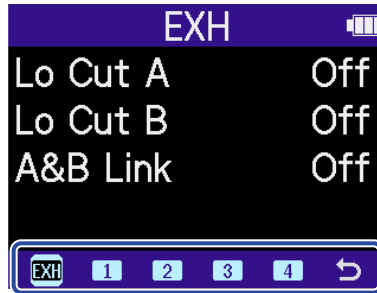

This opens the Input Settings Screen.

2. Use the  (selection) dial to select "EXH" and press the  (ENTER) button.

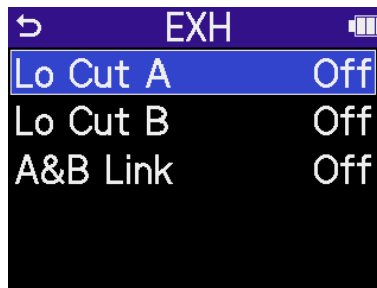

3. Use the  (selection) dial to select "Lo Cut A" or "Lo Cut B" and press the  (ENTER) button.

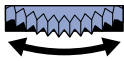

4. Use the  (selection) dial to select the cut-off frequency and press the  (ENTER) button.

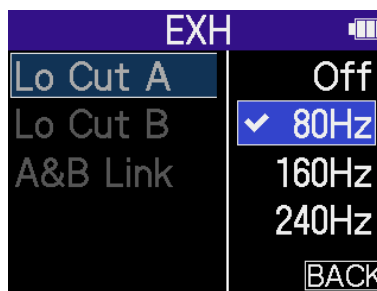

Lo Cut can be set to Off, 80 Hz, 160 Hz or 240 Hz.

Pausing recording

By pausing recording and not recording unwanted intervals, microSD card capacity can be conserved.

1. Press the  (PLAY/PAUSE) button when recording.

This pauses recording.

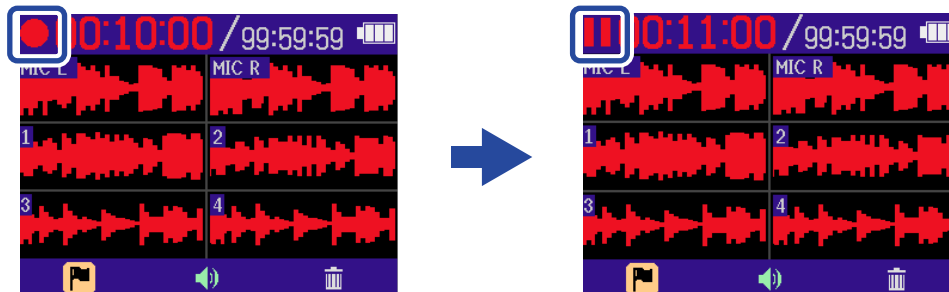

Press the  (PLAY/PAUSE) button again to resume recording.

NOTE

Resuming recording will automatically add a mark at that point.

Function added in Version 1.1

This function allows guide sounds to be turned on/off anytime to suit the use situation.

Turning guide sounds on/off with a shortcut

Turning the guide sound on/off

1. When the HOME screen is open, press and hold the  (ENTER) button.

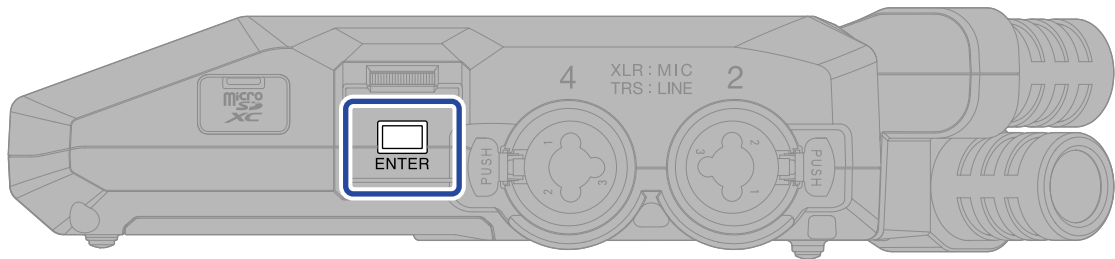

This turns on/off guide sounds.



Home Screen



A notification about the switch will be shown (and announced with the guide sound).

Notes about this manual

Recording from copyrighted sources, including CDs, records, tapes, live performances, video works and broadcasts, without permission of the copyright holder for any purpose other than personal use is prohibited by law. ZOOM CORPORATION will not assume any responsibility related to infringements of copyrights.



ZOOM CORPORATION

4-4-3 Kanda-surugadai, Chiyoda-ku, Tokyo 101-0062 Japan

zoomcorp.com