

H5studio

Handy Recorder



Version 1.60 Supplementary Manual

You must read the Usage and Safety Precautions before use.

©2026 ZOOM CORPORATION

Copying or reprinting this manual in part or in whole without permission is prohibited.

Product names, registered trademarks and company names in this document are the property of their respective companies. All trademarks and registered trademarks in this document are for identification purposes only and are not intended to infringe on the copyrights of their respective owners.

Proper display is not possible on grayscale devices.

Features added and changed from Version 1.60

■ Function added in Version 1.60

Support for SMPTE timecode input/output using a ZOOM TCA-1 timecode adapter (sold separately) has been added.

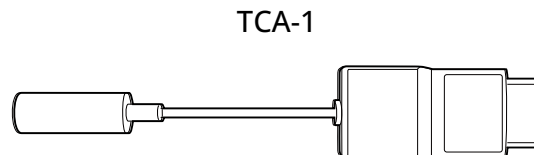

■ Function Modified in Version 1.60

The item names in the Bluetooth menu have been changed.

Previous firmware versions

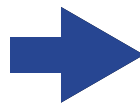
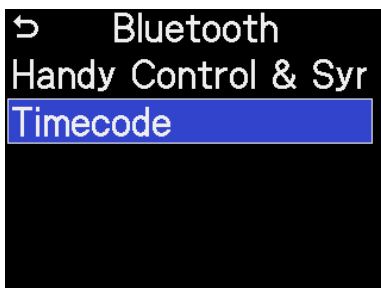

Firmware Ver. 1.60 and later



Contents

- Features added and changed from Version 1.60.....2
- Timecode Overview.....4
 - Connection Examples.....5
- Synchronize with external devices using a TCA-1 timecode adapter.....8
 - Connecting the TCA-1 to the H5studio.....8
 - Setting the mode.....9
 - Outputting timecode only during recording.....12
 - Making internal timecode run on its own when external timecode input is lost.....14
 - Synchronizing (jamming) the timecode.....16
 - Setting the frame rate for the internal timecode.....20
 - Setting the User Bits of the Internal Timecode.....22
 - Setting the delay time for automatic timecode recording.....26
 - Changing connector settings to match the connected device.....28
 - Managing the TCA-1 firmware.....30
- About This Manual.....31

Timecode Overview

Timecode is supplementary time information written into files when recording video or audio. When recording with multiple cameras or recorders, synchronizing the timecode allows editing software to automatically align footage based on the timecode, significantly streamlining synchronization work. The format is represented as "hh:mm:ss:ff" (hours:minutes:seconds:frames).

HINT

The TCA-1 utilizes a high-precision oscillator to generate accurate timecode with an error margin of ± 0.5 frames every 24 hours.

NOTE

- The same frame rate settings must be used by all equipment and all video and audio data.
- The SMPTE timecode standard supports frame rates up to 30 fps. When shooting at high frame rates (60 fps, 59.94 fps, etc.), set the value to half the camera's setting. (→ [Setting the frame rate for the internal timecode](#))

Connection Examples

As examples of timecode connection, we explain two methods: Using an H5studio as the reference and Using an external timecode generator as the reference.

Using an H5studio as the reference (synchronizing with a camera)

Use the TCA-1 to output timecode from the H5studio to the camera. By setting the H5studio as the "reference," timecode can be recorded that matches (synchronizes) the audio data from this unit with the video data from the camera.

For this connection, the following modes can be selected: Int Free Run, Int Rec Run, Time of Day (→ [Setting the mode](#))

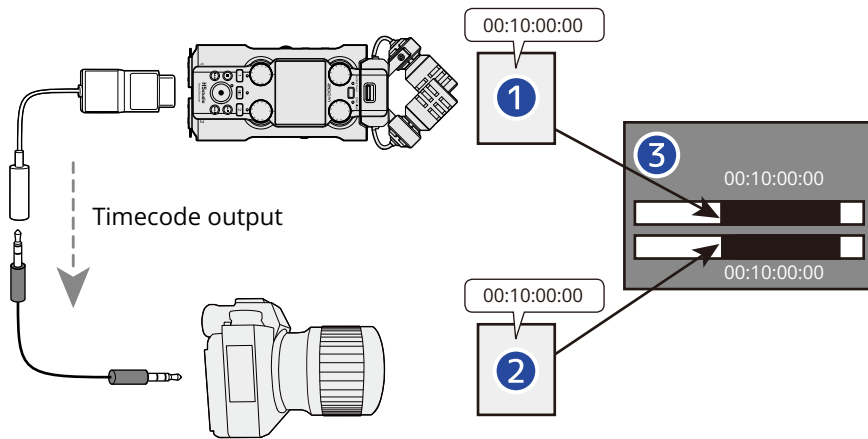

- 1 Recorder**
Records the timecode output by the TCA-1 together with the audio into the file.
- 2 Camera**
Records the received timecode into the file along with the video.
- 3 During Editing**
Video and audio can be synchronized based on the timecode.

Synchronization when using a timecode generator or external device as the reference

Connect the TCA-1 to an external timecode generator.

Use the timecode generator as the "reference" to synchronize the H5studio and camera, recording the same timecode to the audio and video.

■ Using in jam mode

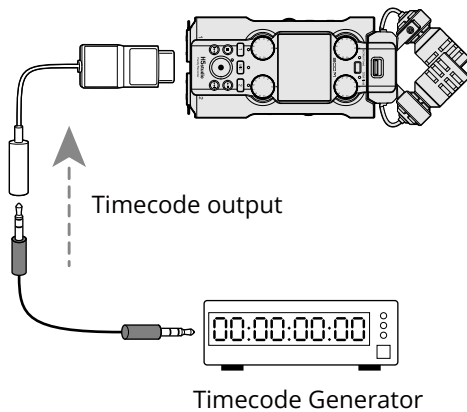

NOTE: No cable needed after jamming

The H5studio receives timecode once from an external timecode generator, synchronizing (jamming) to it. After jamming, the H5studio's clock maintains the timecode even if the connection is disconnected.

- Set the operating mode to match other devices used at the same time.
- The default sync mode is "Int Free Run". In this mode, the timecode continuously advances. Jamming before recording video allows maintaining synchronization across multiple devices. (→ [Setting the mode](#))

HINT

Jamming overview

This function synchronizes the timecode of the connected device with the timecode of the reference device. Jamming matches the H5studio's timecode with the externally input value. Once synchronized, even if the cable is disconnected, the unit will continue counting (running free) using its internal high-precision clock.

■ Using with a constant connection

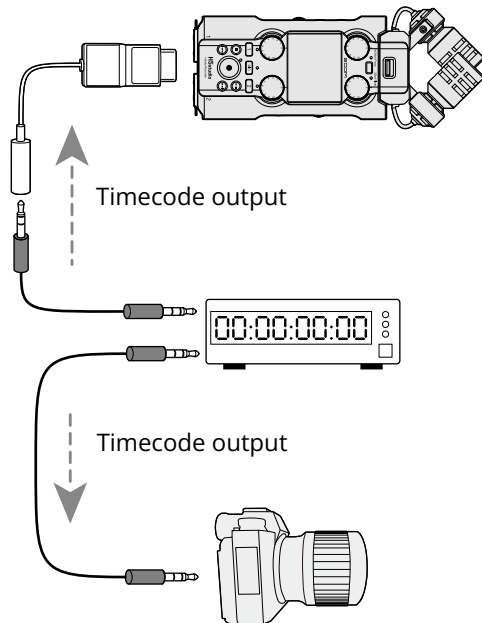

Synchronize by continuously receiving timecode from a timecode generator or similar source. For this connection, you can select the following modes: "Ext" or "Ext Auto Rec". (→ [Setting the mode](#))

Selecting "Ext Auto Rec" automatically starts/stops recording in sync with the external timecode output.



- Use "Auto Rec Delay" to adjust the delay time between receiving the timecode and starting recording. (→ [Setting the delay time for automatic timecode recording](#))
- The behavior when timecode output is interrupted can be selected using the "Ext Continuous" setting. (→ [Making internal timecode run on its own when external timecode input is lost](#))

Synchronize with external devices using a TCA-1 timecode adapter

Connecting the TCA-1 to the H5studio

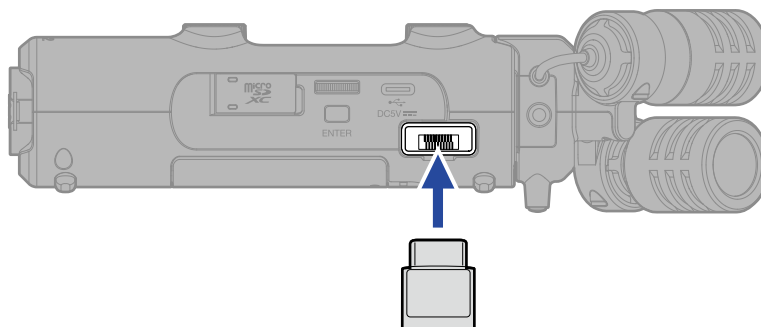
1. With the H5studio powered off, remove the cover from the REMOTE terminal on the right side and connect the TCA-1.

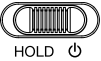

2. Slide the  (Power/HOLD) switch toward the  (INPUT 1/INPUT 3 jacks) until the power turns on, activating the display.

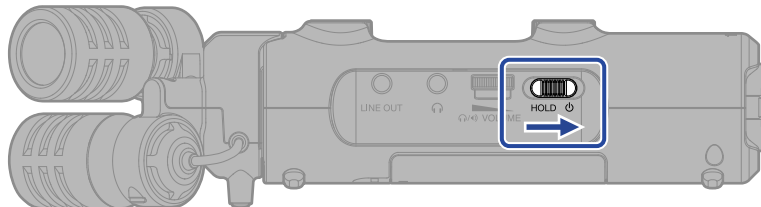

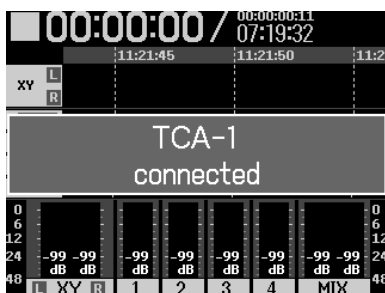

Confirm that "TCA-1 connected" is shown.



Setting the mode

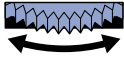

The following settings can be made, for example.

- Outputting timecode from the TCA-1 and inputting timecode from an external source
- Enable/disable timecode running independently outside of recording

1. On the Home Screen, select  "SYSTEM" using the  (selection) dial and press the  (ENTER) button.
The System Settings Screen will appear.

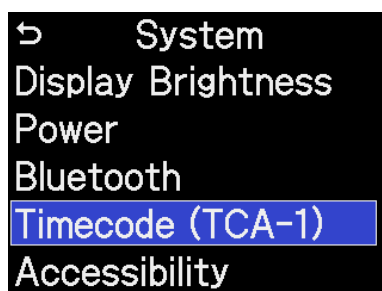
2. Use the  (selection) dial to select "Timecode (TCA-1)" and press the  (ENTER) button.



3. Use the  (selection) dial to select "Mode" and press the  (ENTER) button.

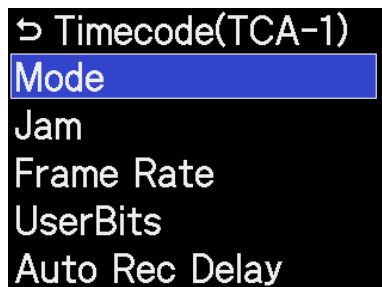

4. Use the  (selection) dial to select "On/Off" and press the  (ENTER) button.

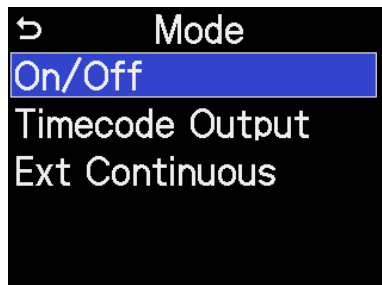

5. Use the  (selection) dial to select the desired setting item and press the  (ENTER) button.

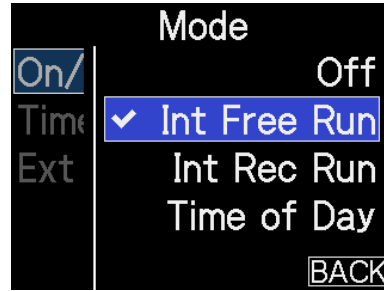



Setting Value	Description
Off	Timecode is not recorded to the recording file. Timecode is not output from the TCA-1.
Int Free Run	<p>The internal timecode continues counting regardless of the recording start/stop state. The start timecode can be set from the following menu items.</p> <ul style="list-style-type: none"> • Jam (→ Jamming the internal timecode) • Restart (→ Restarting the internal timecode at any set value) <p>Timecode output can be switched between "Always" and "Rec Only" using the "Timecode Output" setting.</p>
Int Rec Run	<p>The internal timecode advances only during recording and stops when recording is paused. The start timecode can be set from the following items.</p> <ul style="list-style-type: none"> • Jam (→ Jamming the internal timecode) • Restart (→ Restarting the internal timecode at any set value) <p>After resuming recording, timecode will restart from the value at the time it stopped. Timecode is only output while recording and is not output when stopped.</p>
Time of Day	<p>This mode synchronizes the internal timecode with the H5studio's internal clock (current time). This is applied automatically when this mode is selected or when the H5studio's date/time (Date/Time) is changed.</p> <p>This time-based timecode is continuously output from the TCA-1.</p>
Ext	<p>This mode operates using timecode input from an external device as the reference. When external timecode is input, the internal timecode follows that external signal.</p> <p>The internal timecode can be set to run independently if the external timecode signal is interrupted. (→ Making internal timecode run on its own when external timecode input is lost)</p>

Setting Value	Description
Ext Auto Rec	In addition the functions of Ext mode, this mode automatically switches the recording state using external timecode detection. Recording starts when external timecode input is detected and stops when the external timecode stops.



Outputting timecode only during recording

Whether or not timecode is output from the TCA-1 when the recorder is stopped can be set.

1. On the Home Screen, select  "SYSTEM" using the  (selection) dial and press the  (ENTER) button.
The System Settings Screen will appear.

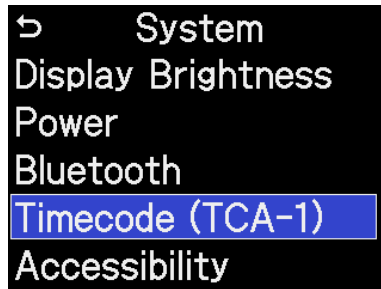
2. Use the  (selection) dial to select "Timecode (TCA-1)" and press the  (ENTER) button.



3. Use the  (selection) dial to select "Mode" and press the  (ENTER) button.

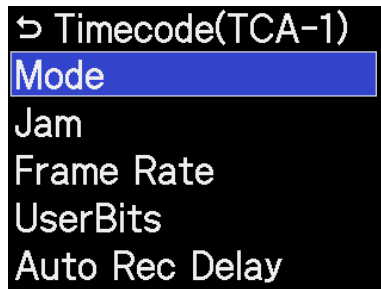

4. Use the  (selection) dial to select "Timecode Output" and press the  (ENTER) button.

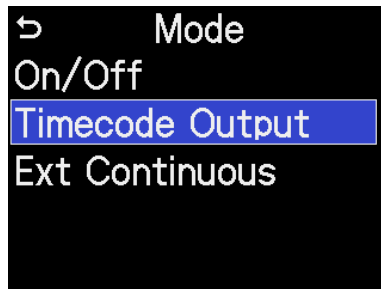

5. Use the  (selection) dial to select "Rec Only" and press the  (ENTER) button.

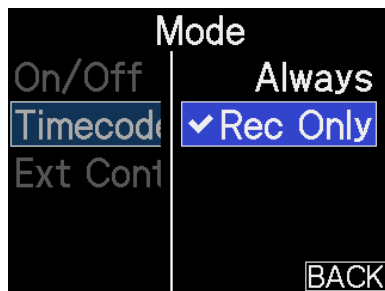



NOTE

Timecode continues to be output when recording is paused.

Making internal timecode run on its own when external timecode input is lost



Internal timecode can be set to run independently to maintain continuity when external timecode is lost.

1. On the Home Screen, select  "SYSTEM" using the  (selection) dial and press the  (ENTER) button.

The System Settings Screen will appear.

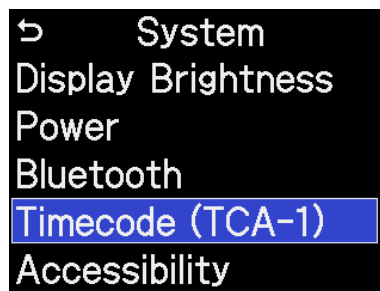
2. Use the  (selection) dial to select "Timecode (TCA-1)" and press the  (ENTER) button.



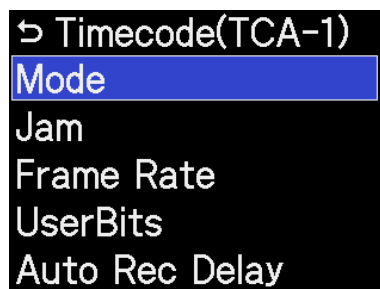

3. Use the  (selection) dial to select "Mode" and press the  (ENTER) button.

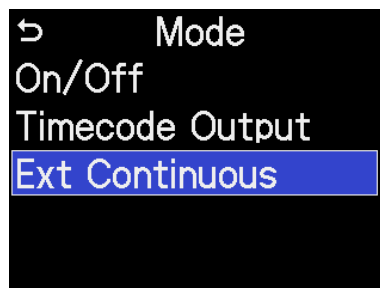

4. Use the  (selection) dial to select "Ext Continuous" and press the  (ENTER) button.



5. Use the  (selection) dial to select "On" and press the  (ENTER) button.

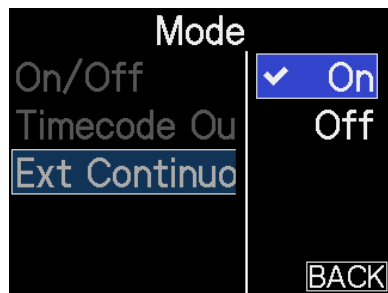



Synchronizing (jamming) the timecode

Jamming the internal timecode

You can synchronize the H5studio's internal timecode with the timecode from an external device. After jamming, it will automatically continue counting up (running free) even if the cable is disconnected.

NOTE

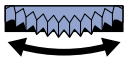
First, connect the external device to the TCA-1. Set the mode to "Int Free Run" or "Int Rec Run".

1. On the Home Screen, select  "SYSTEM" using the  (selection) dial and press the  (ENTER) button.
The System Settings Screen will appear.

2. Use the  (selection) dial to select "Timecode (TCA-1)" and press the  (ENTER) button.

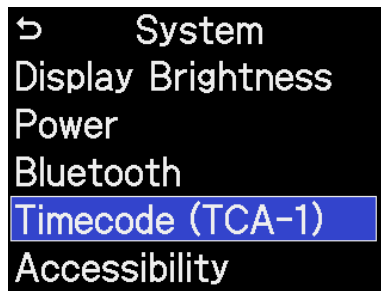

3. Use the  (selection) dial to select "Jam" and press the  (ENTER) button.

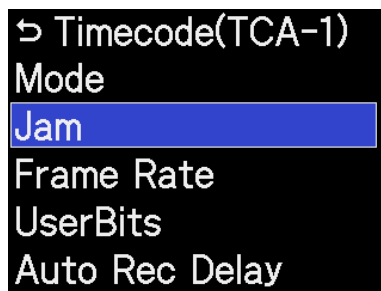

4. Use the  (selection) dial to select "Jam" and press the  (ENTER) button.

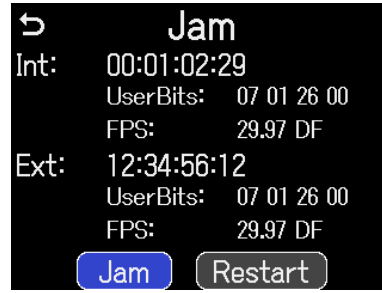



Restarting the internal timecode at any set value

The H5studio's internal timecode can be set to any value, and counting up can be resumed from that value.

NOTE

Set the mode to "Int Free Run" or "Int Rec Run".

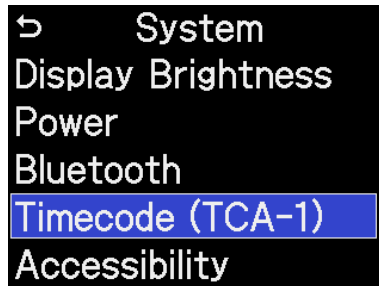

1. On the Home Screen, select  "SYSTEM" using the  (selection) dial and press the  (ENTER) button.
The System Settings Screen will appear.

2. Use the  (selection) dial to select "Timecode (TCA-1)" and press the  (ENTER) button.

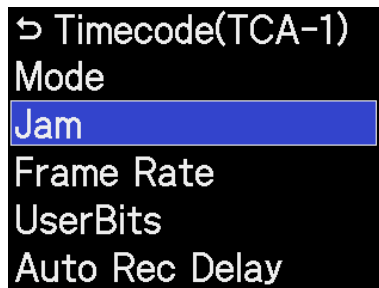

3. Use the  (selection) dial to select "Jam" and press the  (ENTER) button.





4. Use the  (selection) dial to select "Restart" and press the  (ENTER) button.



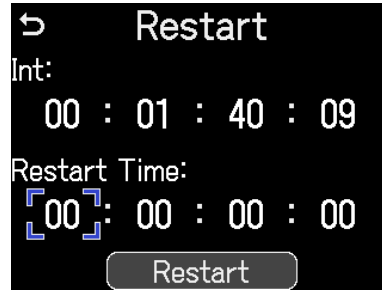

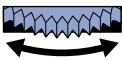
5. Use the  (selection) dial to select the desired setting item and press the  (ENTER) button.



6. Use the  (selection) dial to change the value and press the  (ENTER) button.



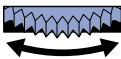

7. Repeat steps 5 and 6 to change all setting values

8. After setting all values, use the  (selection) dial to select "Restart" and press the  (ENTER) button.

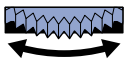

Setting the frame rate for the internal timecode

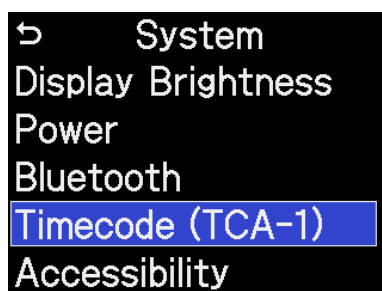

1. On the Home Screen, select  "SYSTEM" using the  (selection) dial and press the  (ENTER) button.
The System Settings Screen will appear.

2. Use the  (selection) dial to select "Timecode (TCA-1)" and press the  (ENTER) button.

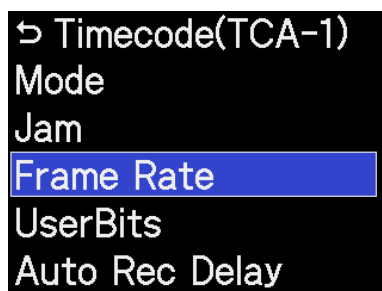

3. Use the  (selection) dial to select "Frame Rate" and press the  (ENTER) button.

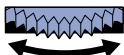

4. Use the  (selection) dial to select the frame rate and press the  (ENTER) button.

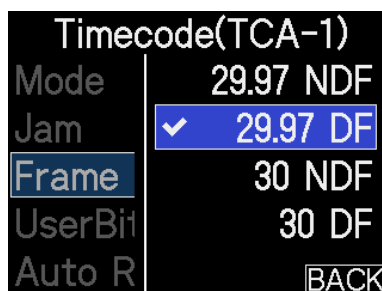

Setting Value	Description
23.976 NDF	This common frame rate is used for high-definition recording, such as with HD cameras. It counts 0.1% slower than real time.
24 NDF	This standard frame rate is used for film shooting and in HD cameras.
25 NDF	This frame rate is for PAL format video, which is used in Europe and other regions.
29.97 NDF	This frame rate is for NTSC color video and HD cameras. It counts 0.1% slower than real time. This is used for NTSC-format video, which is used in Japan, the United States, and other countries.
29.97 DF	This frame rate is adjusted using drop frame timing to match NTSC to the actual time. This is used for broadcast video that requires synchronization with actual time frames.
30 NDF	This is used to synchronize sound to film being transferred to NTSC video. This is the standard frame rate for black-and-white television in Japan, the United States, and other regions.
30 DF	This specialized frame rate is used to synchronize film sound to NTSC using 29.97fps drop frame timing. It counts 0.1% faster than actual time.

NOTE

- Frame rate settings must be the same across all equipment, video data, and audio data used.
- The SMPTE timecode standard supports frame rates up to 30 fps. When shooting at high frame rates (60 fps, 59.94 fps, etc.), set the value to half the camera's recording frame rate.
 - When shooting at 60fps: "30 NDF" or "30 DF"
 - When shooting at 59.94fps: "29.97 NDF" or "29.97 DF"
 - When shooting at 50fps: "25 NDF"





Setting the User Bits of the Internal Timecode

HINT



Definition of User Bits

"User Bits" refers to an 8-digit data field that can be recorded in the timecode signal, separately from the "Hour:Minute:Second:Frame" time information. Using the digits 0-9 and the letters A-F (hexadecimal), this field can be used to record identifying information such as the shooting date, camera ID, or scene number. This information can be read by video editing software and is useful for organizing footage from multiple cameras or recorders.

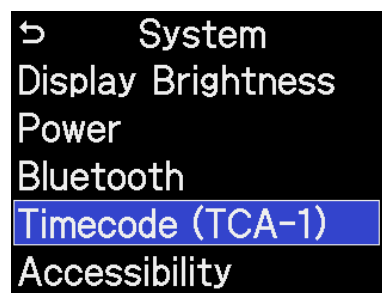

Setting the user bit mode

1. On the Home Screen, select  "SYSTEM" using the  (selection) dial and press the  (ENTER) button.
The System Settings Screen will appear.
2. Use the  (selection) dial to select "Timecode (TCA-1)" and press the  (ENTER) button.



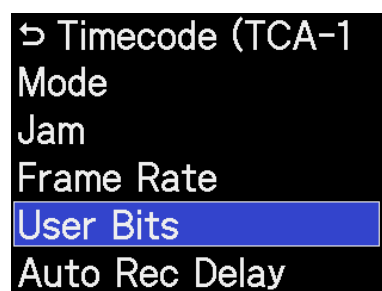

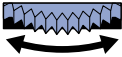
3. Use the  (selection) dial to select "User Bits" and press the  (ENTER) button.

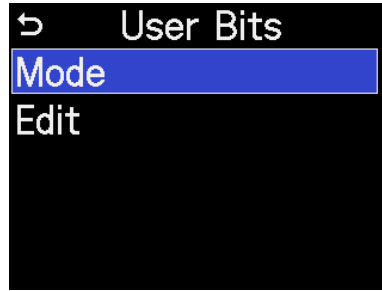

4. Use the  (selection) dial to select "Mode" and press the  (ENTER) button.

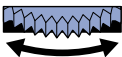

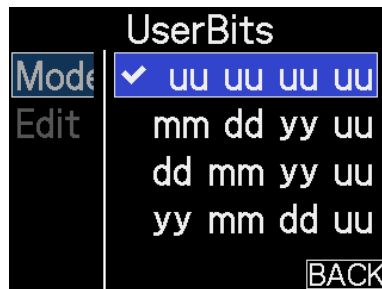

5. Use the  (selection) dial to select the item to set and press the  (ENTER) button.



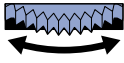

Setting Value	Description
uu uu uu uu	This can be set to any value on the Edit Screen.
mm dd yy uu	The date set in the H5studio is automatically entered in the order of month, day, year, and user bit, which can be set to any value on the Edit Screen.
dd mm yy uu	The date set in the H5studio is automatically entered in the order of day, month, year, and user bit, which can be set to any value in the "edit" screen.
yy mm dd uu	The date set in the H5studio is automatically entered in the order of year, month, day, and user bit, which can be set to any value in the "edit" screen.

Setting User Bits

1. On the Home Screen, select  "SYSTEM" using the  (selection) dial and press the  (ENTER) button.
The System Settings Screen will appear.

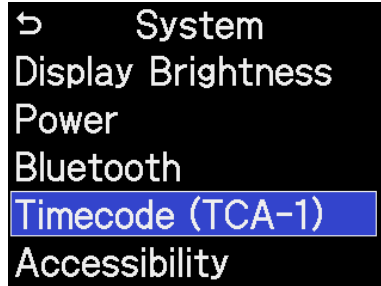
2. Use the  (selection) dial to select "Timecode (TCA-1)" and press the  (ENTER) button.



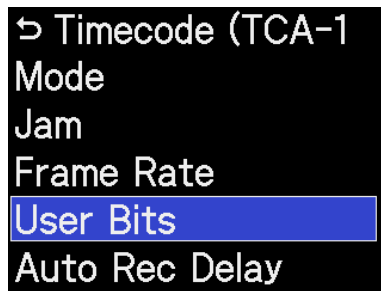

3. Use the  (selection) dial to select "User Bits" and press the  (ENTER) button.



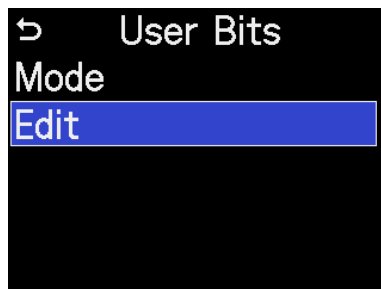

4. Use the  (selection) dial to select "Edit" and press the  (ENTER) button.

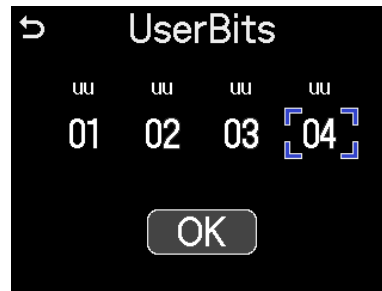

5. Use the  (selection) dial to change the value and press the  (ENTER) button.

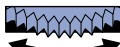

6. After setting all values, use the  (selection) dial to select "OK" and press the  (ENTER) button.

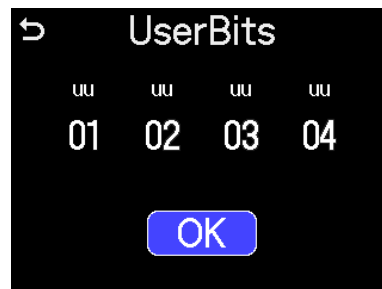

NOTE

Only items set to "uu" in "Mode" can be changed.



HINT

Values can be set within the range 00 to FF.

Setting the delay time for automatic timecode recording

When configured to automatically record upon receiving external timecode, momentary timecode reception may trigger unwanted recordings.



To avoid this, a delay can be set between receiving the timecode and starting recording.

1. On the Home Screen, select  "SYSTEM" using the  (selection) dial and press the  (ENTER) button.

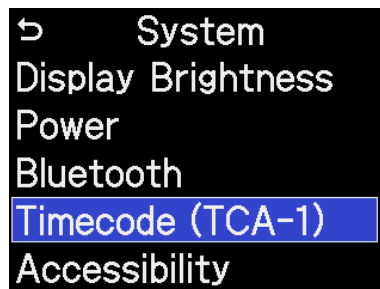

The System Settings Screen will appear.

2. Use the  (selection) dial to select "Timecode (TCA-1)" and press the  (ENTER) button.



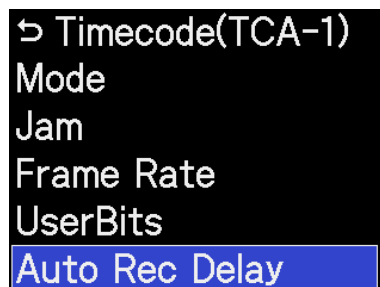

3. Use the  (selection) dial to select "Auto Rec Delay" and press the  (ENTER) button.



4. Use the  (selection) dial to select the value and press the  (ENTER) button.

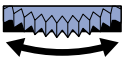

5. Use the  (selection) dial to change the value and press the  (ENTER) button.



6. Use the  (selection) dial to select "OK" and press the  (ENTER) button.

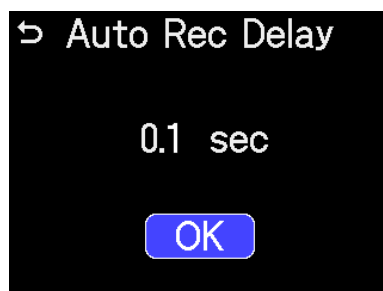



HINT

This can be set in a range from 0.0 to 8.0 seconds.



Changing connector settings to match the connected device

Configure whether the 3.5mm jack connected to the TCA-1 handles signals via the tip or ring to suit the external device.

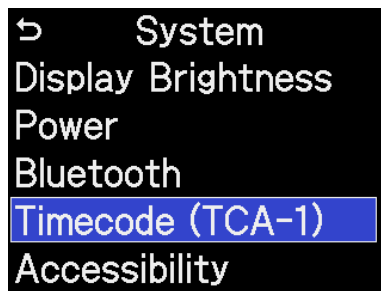

1. On the Home Screen, select  "SYSTEM" using the  (selection) dial and press the  (ENTER) button.
The System Settings Screen will appear.

2. Use the  (selection) dial to select "Timecode (TCA-1)" and press the  (ENTER) button.

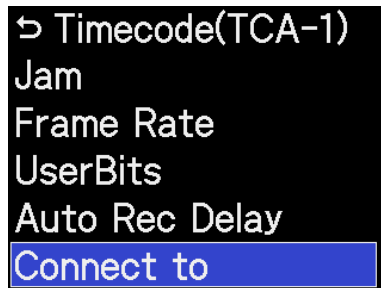

3. Use the  (selection) dial to select "Connect to" and press the  (ENTER) button.

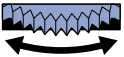

4. Use the  (selection) dial to select the item for the connected device and press the  (ENTER) button.

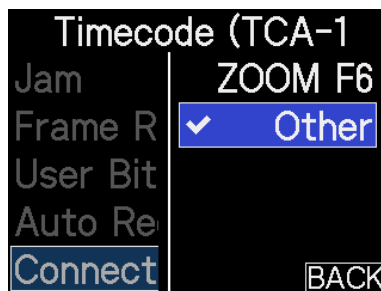

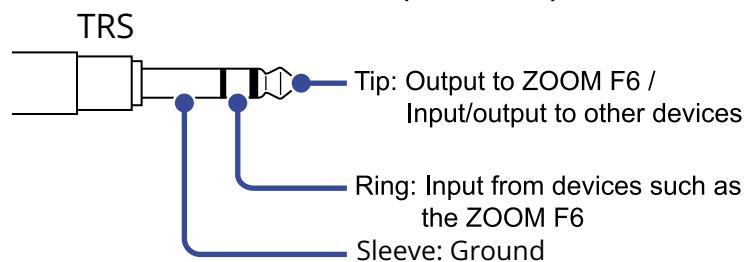

Setting Value	Description
ZOOM F6	<p>This mode assigns the tip for output and the ring for input. Select this when connecting to a ZOOM F6 or another device with similar connector specifications.</p> <p>Signal passing through the tip: This outputs the timecode signal generated by the TCA-1 to external devices.</p> <p>Signal passing through the ring: This inputs the timecode signal generated by an external device into the TCA-1.</p>
Other	<p>This mode handles timecode input/output solely through the tip. On the Jam Screen, the signal passing through the tip switches automatically.</p> <p>Signal passing through the tip:</p> <ul style="list-style-type: none"> • This outputs the timecode signal generated by the TCA-1 to external devices. • This inputs the timecode signal generated by an external device into the TCA-1.

Timecode Input / Output



Managing the TCA-1 firmware

Checking the firmware version

1. On the Home Screen, select  "SYSTEM" using the  (selection) dial and press the  (ENTER) button.
The System Settings Screen will appear.

2. Use the  (selection) dial to select "Timecode (TCA-1)" and press the  (ENTER) button.

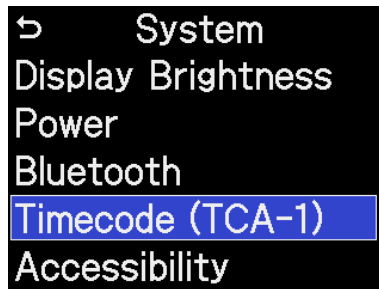

3. Use the  (selection) dial to select "Firmware(TCA-1)" and press the  (ENTER) button.

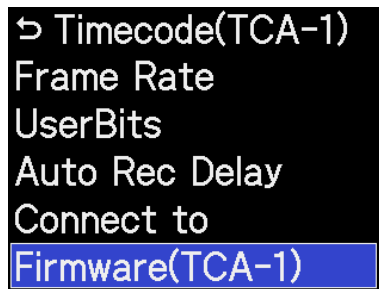

Updating the firmware

The TCA-1 firmware can be updated to the latest version.

The latest firmware update file can be downloaded from the ZOOM website (zoomcorp.com/help/tca-1).

Follow the instructions in the "TCA-1 Firmware Update Guide" on the TCA-1 download page.

About This Manual

Recording from CDs, records, tapes, performances, video works, broadcasts, and other media for which others hold the copyright without the rights holder's permission, except for personal use, is prohibited by law. Zoom Corporation assumes no responsibility whatsoever for actions that infringe copyrights.



ZOOM CORPORATION

4-4-3 Kanda-surugadai, Chiyoda-ku, Tokyo 101-0062 Japan

zoomcorp.com