

H3-VR

Handy Recorder

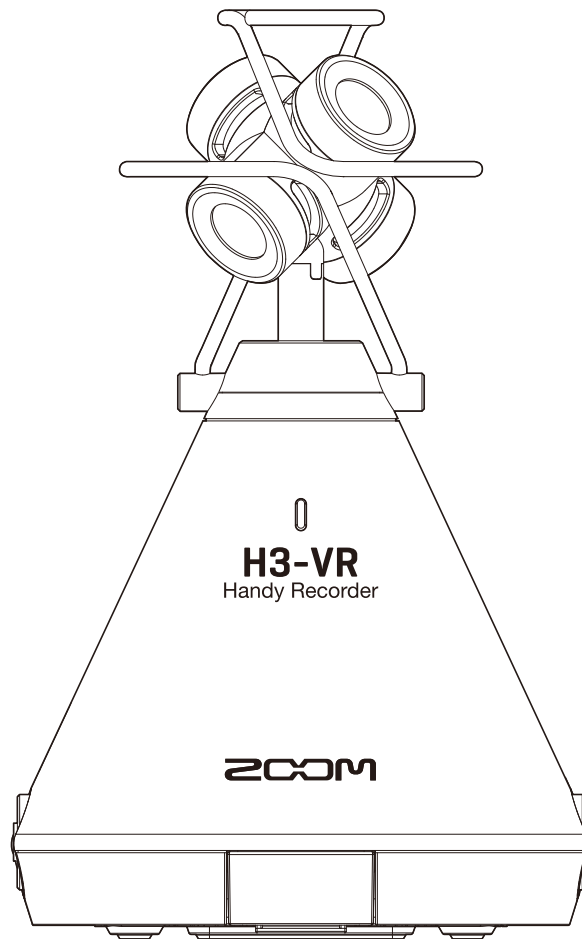

Operation Manual

You must read the Usage and Safety Precautions before use.

© 2018 ZOOM CORPORATION

Copying or reprinting this manual in part or in whole without permission is prohibited.

Notes about this Operation Manual

You might need this manual in the future. Always keep it in a place where you can access it easily.
The contents of this document and the specifications of the product could be changed without notice.

- Windows® is a trademark and registered trademark of Microsoft® Corporation.
- Macintosh, macOS and iPad are trademarks or registered trademarks of Apple Inc.
- The microSD, microSDHC and microSDXC logos are trademarks.
- The Bluetooth® word mark and logo are registered trademarks of Bluetooth SIG, Inc. and these marks are used under license by Zoom Corporation. Other trademarks and trade names are the property of their respective companies.
- Other product names, registered trademarks and company names in this document are the property of their respective companies. All trademarks and registered trademarks in this document are for identification purposes only and are not intended to infringe on the copyrights of their respective owners.
- Recording from copyrighted sources, including CDs, records, tapes, live performances, video works and broadcasts, without permission of the copyright holder for any purpose other than personal use is prohibited by law. Zoom Corporation will not assume any responsibility related to infringements of copyrights.
- Google Spatial Audio HRIRs
Copyright 2016 Google Inc. All Rights Reserved.
This product includes HRTFs (head related impulse responses) developed by Google Inc.
Google Spatial Audio is released under Apache License 2.0.
<http://www.apache.org/licenses/LICENSE-2.0>

THESE HRTFs WERE MODIFIED BY ZOOM.

Length: first 64 samples

Filter: low shelf

Introduction

Thank you very much for purchasing a ZOOM **H3-VR** Handy Recorder (hereafter, "**H3-VR**"). The **H3-VR** has the following features.

Capture 360° audio with the high-quality Ambisonic mic

The Ambisonic mic, which can handle sound pressure input up to 120 dB SPL, can record 360° audio in every direction, including above and below, at high resolutions up to 24-bit/96kHz. With data recorded in an Ambisonic format, you can turn the sound image during playback and extract the sounds of specific directions.

Easily record spatial audio for virtual-reality content

Along with Ambisonics A, Ambisonics B FuMa and AmbiX formats are also supported. The mic position can be detected automatically when recording starts. Simply adjust the placement angle while checking the built-in electronic tilt indicator for worry-free playback.

Simply orient the H3-VR to listen to the desired direction during playback

By orienting the **H3-VR** when in tracking playback mode, it can use the built-in motion sensor to generate the playback sound for the desired direction from the data recorded in every direction.

Re-create the feeling of being there with binaural audio

Binaural recording, which is intended for playback through headphones, is supported. This recording format recreates the sound that not only reaches the ears of a person directly, but also the sound that is transmitted through the head, face and body.

360° USB mic and audio interface

When live streaming, conducting video meetings and recording to DAW software, for example, using the audio interface functions of the **H3-VR**, you can connect it to a computer to use it as a 360° USB mic or an iOS device to use it as a stereo mic.

Remote operation from an iPhone/iPad

By installing a dedicated wireless adapter (BTA-1), and using the H3 Control iOS app, you can control the **H3-VR** from a short distance away. Using an iPhone or iPad, wirelessly operate the transport, set levels and input metadata, for example, without worrying about noise from touching the built-in interface.

Unrestricted post-production

Using the free ZOOM Ambisonics Player application for Windows and Mac, you can convert Ambisonic files to ordinary stereo, binaural and 5.1 surround, for example, and play them back. Moreover, you can extract audio from specific directions to write stereo audio files.

Contents

Notes about this Operation Manual	2
Introduction	3
Contents	4
What is 3D sound?	7
3D sound overview	7
Ambisonics formats	7
Features	7
Recording formats	8
Binaural format	10
Features	10
Recording examples	11
Example 1: studio recording	11
Example 2: live recording	11
Example 3: field recording	12
Names of parts	13
Preparations	17
Supplying power	17
Using batteries	17
Using an AC adapter	19
Inserting microSD cards	20
Turning the power on/off	22
Turning the power on	22
Turning the power off	22
Preventing misoperation (HOLD function)	23
Activating the HOLD function	23
Deactivating the HOLD function	23
Setting the language shown (first time starting up)	24
Setting the date and time (first time starting up)	25
Recording	26
Home Screen (in recording standby)	26
Preparing to record	27
Setting the mic position	27
Setting the recording mode	30
Setting the recording format	32
Monitoring the input sound	34
Setting Ambisonic monitoring	35
Adjusting input levels	37
Setting low-frequency cutoff filter	38
Setting the limiter	40
Setting file names	45

Enabling the sound marker function.....	47
Setting the recording time display	49
Recording.....	51
Playback	52
Playing recordings	52
Changing the playback mode.....	53
Setting the playback time display	58
Managing folders and files	60
Creating folders.....	60
Selecting folders and files	62
Changing folder and file names	65
Checking file information	67
Checking file marks.....	69
Deleting marks	72
Deleting folders and files.....	73
Adjusting connected equipment levels (playing test tones)	75
Using USB functions	77
Using as a card reader.....	77
Connecting to a computer	77
Disconnecting from a computer	79
Using as an audio interface.....	80
Connecting to a computer or iOS device.....	80
Disconnecting from a computer or iOS device	82
Audio interface settings	83
Enabling direct monitoring	83
Enabling the loop back function.....	84
Operating with an iOS device	85
Pairing with an iOS device	85
Disconnecting from an iOS device.....	86
Inputting characters	87
Setting the type of batteries used	88
Setting the display backlight	90
Adjusting the display contrast	92
Setting the language shown	94
Setting the date and time	95
Formatting microSD cards	98
Testing microSD card performance	100
Conducting a quick test.....	100
Conducting a full test.....	103

Restoring default settings (Factory Reset) 106

Checking the firmware versions..... 108

Updating the firmware..... 110

Responding to Alert Messages 112

Troubleshooting..... 114

 Recording/playback trouble 114

 Other trouble..... 114

Metadata list 116

Specifications 118

What is 3D sound?

3D sound overview

While traditional stereo sound captures horizontal placement, three-dimensional sound recording methods also capture up-down and front-back placement to create 3D sound images.

The **H3-VR** supports two 3D methods: Ambisonics and binaural.

Ambisonics formats

Features

- Multiple mics capture sound in all directions: left, right, up, down, front and back.
- Audio sources captured on multiple tracks can be processed, and sound can be extracted from any chosen direction.
- The sound can be rotated. For example, sound can be continuously re-created as the listener turns around to face the opposite direction.

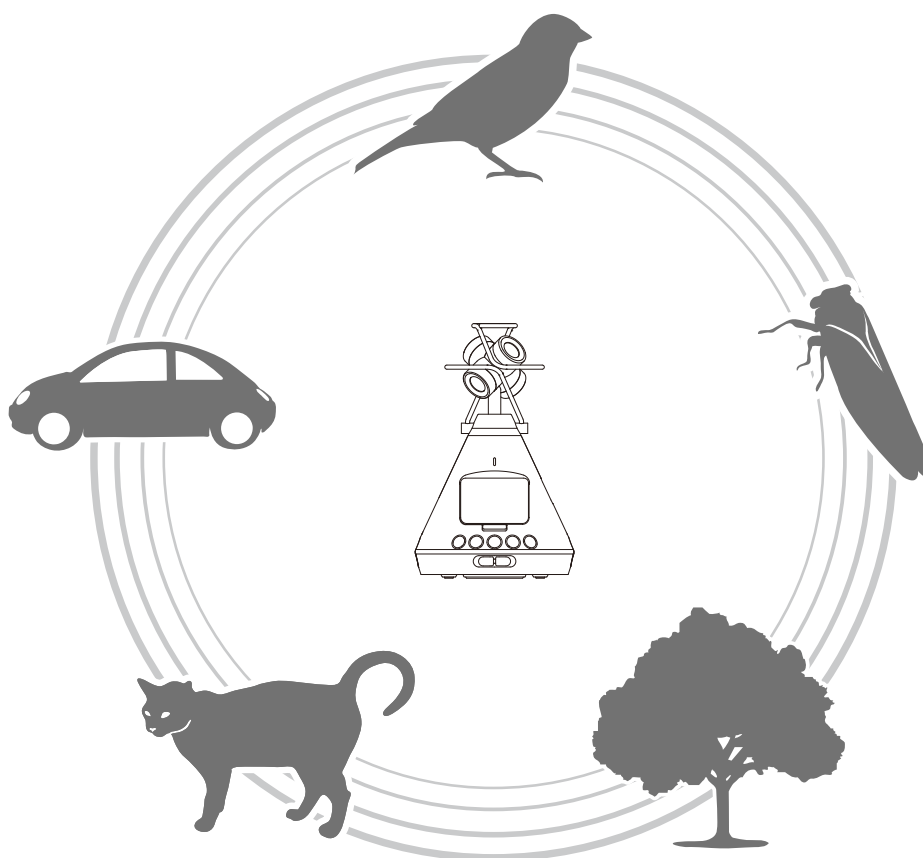

Recording formats

Since the sound recorded by each mic is saved separately in a multichannel format, it can be edited for a variety of playback situations, including 2-channel stereo, 5.1-channel surround and VR video.

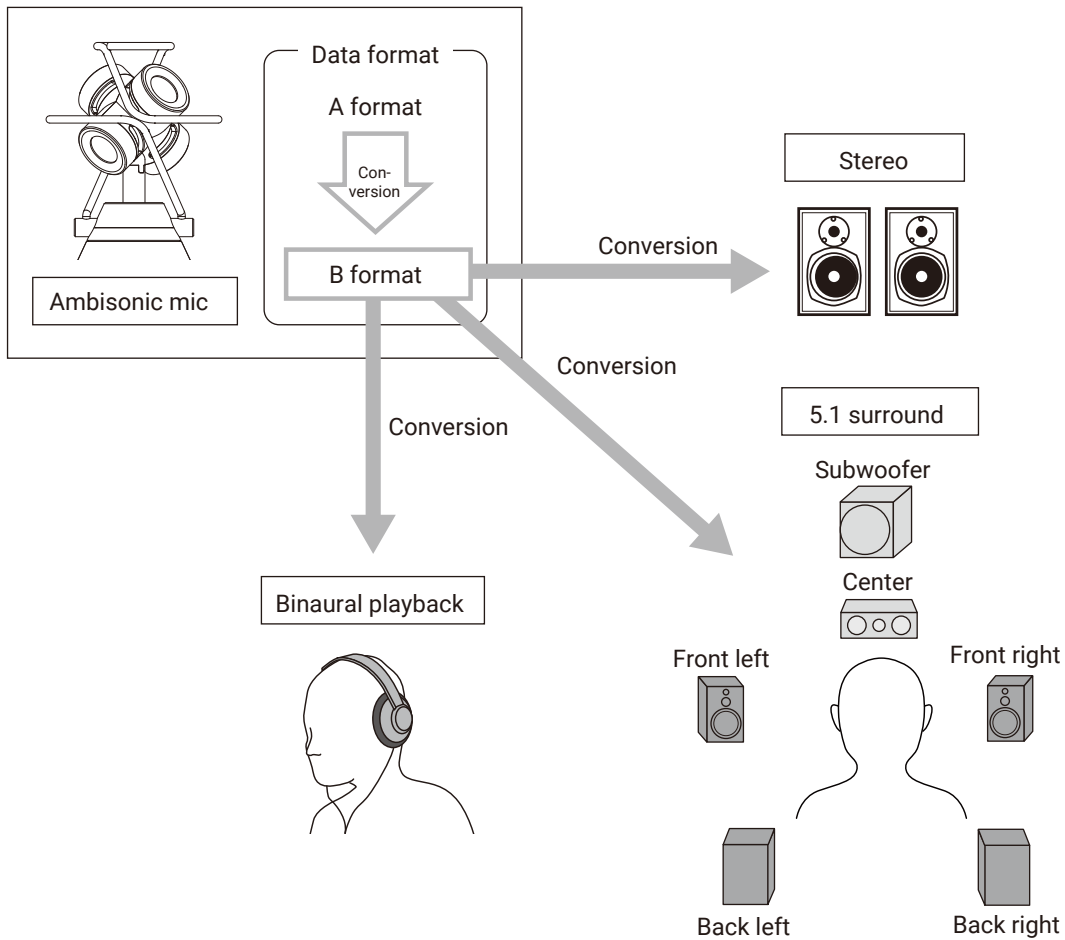

- A format (Ambisonics A)

Audio data for the four directional mics are recorded as is. This format as is cannot reproduce sounds in all directions.

Mic names and recording fields

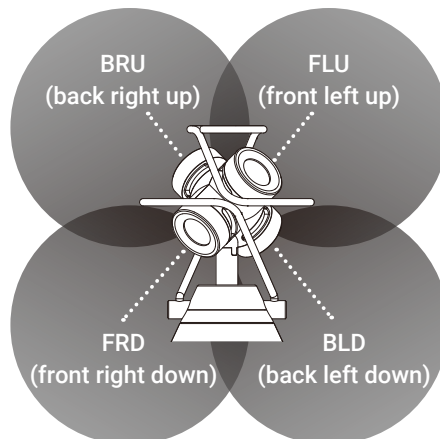

- B format (Ambisonics B)

A format data is processed and distributed to four channels (W/X/Y/Z) to produce this audio data.
The **H3-VR** supports FuMa and AmbiX.

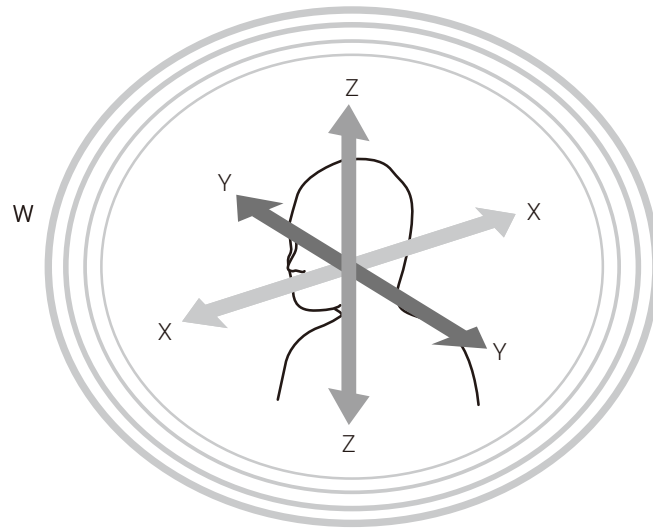

Binaural format

Features

- The binaural format records the sound that not only reaches the ears of a person directly, but also the sound that is transmitted through the head, face and body.

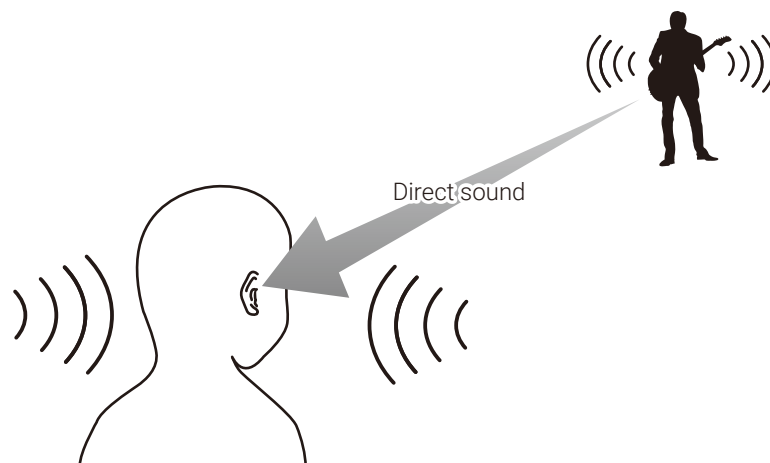

- In principle, this is sound recorded as though mics were placed inside both ears of a person. This type of mic setup also exists.

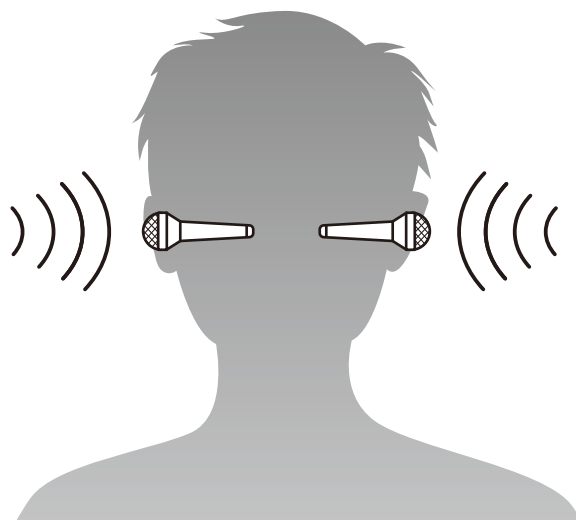

The **H3-VR** converts audio data recorded with the four mics into binaural format recordings.

Recording examples

Example 1: studio recording

Placing the **H3-VR** in the middle of a band arranged in a circle, a performance that allows the watcher to focus freely on different members can be created by recording in Ambisonics format together with VR video recording.

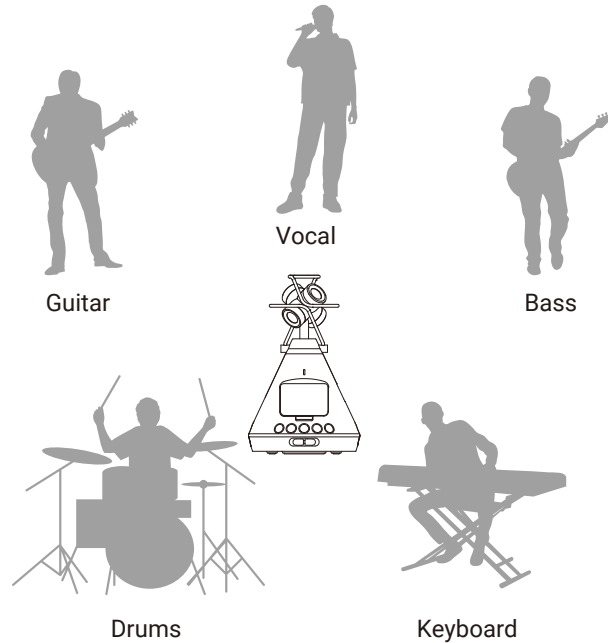

Example 2: live recording

- By recording a live performance from an audience seat in binaural format, the feeling of actually listening in the live venue can be re-created.
- With the **H3-VR** in the middle of the venue, the sound of the entire place, including reverberations and the audience, can be recorded. Mixing this recording with a line recording from a PA or other audio equipment enables the creation of a more realistic live sound.

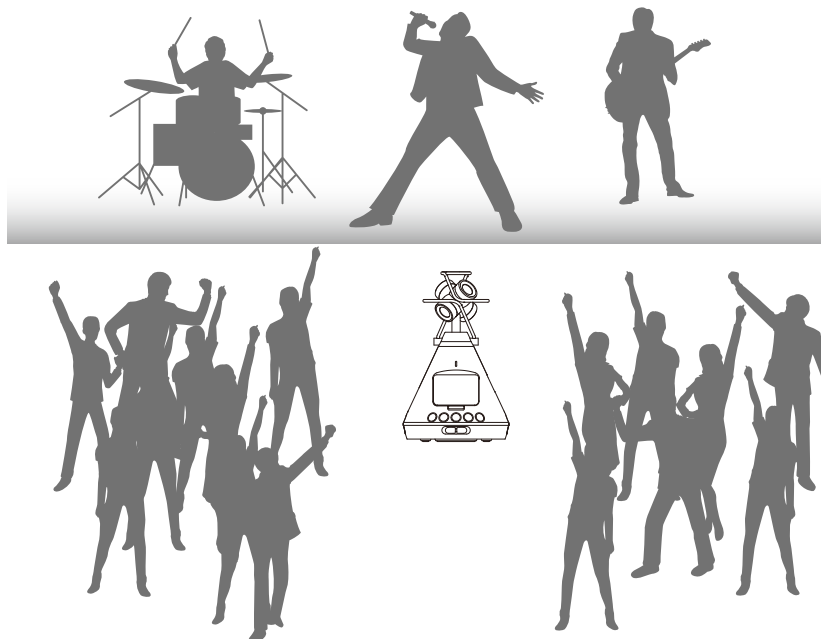

Example 3: field recording

- When recording in nature, instead of just focusing on a bird, a stream or another sound source, the complete sound of the natural setting, including reflections from trees, rocks and other objects, can be captured.



- When recording the sound of a train, in addition to the sound of it moving horizontally, vertical changes and reverberations and other sounds from the surrounding space can also be recorded. By turning the sound away from the tracks during playback, the sound of the train passing behind the listener can be re-created realistically.

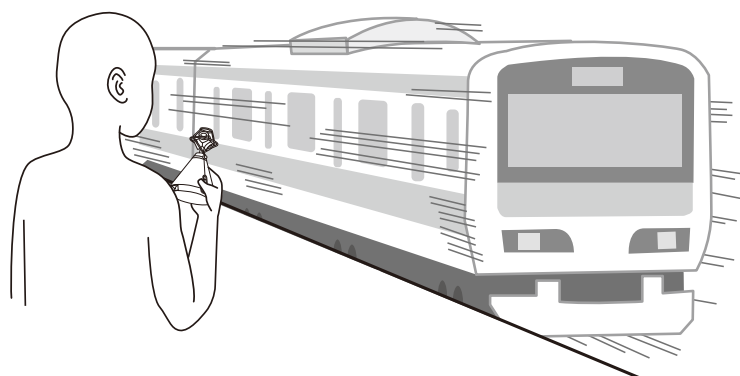

Names of parts

■ Front

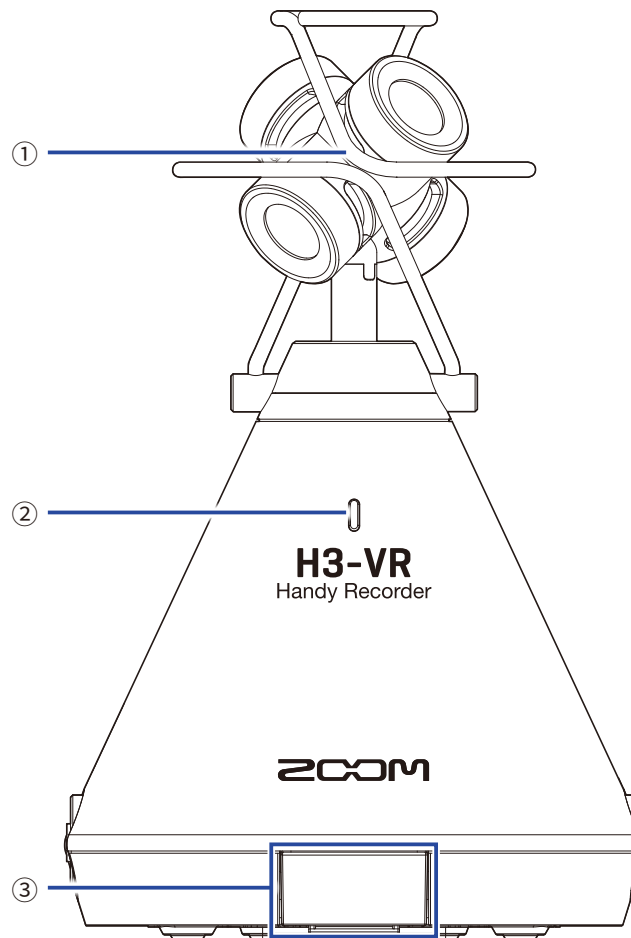

① Built-in Ambisonic mic

This Ambisonic mic is comprised of four unidirectional condenser mic capsules. This mic can record a three-dimensional sound with natural depth and width.

② REC LED

This lights during recording, blinks when recording is paused, and blinks rapidly when the input sound level is high.

③ REMOTE connector

Connect a BTA-1 or other dedicated wireless adapter here. This enables operation of the **H3-VR** from an iOS device using a dedicated controller app.

■ Back

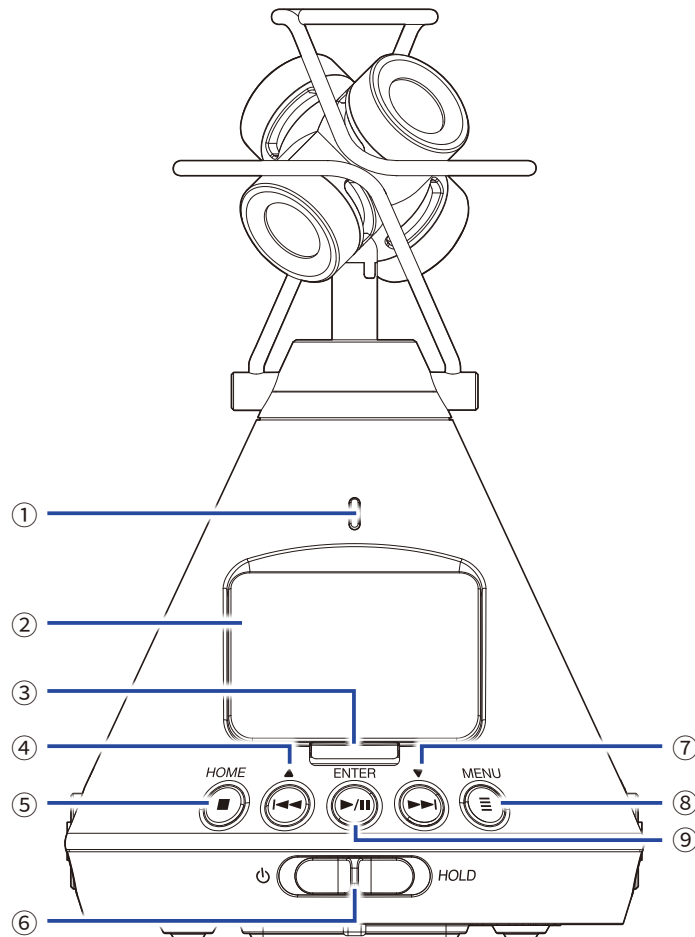

① REC LED

This lights during recording, blinks when recording is paused, and blinks rapidly when the input sound level is high.

② Display

This shows various types of information.

③ REC button

Use this to start/stop recording.

④ REW / ▲ button

Use to search backward to a playback position in a file and to select items.

⑤ STOP/HOME button

Use to stop file playback and to open the Home Screen.

⑥ Power switch

Use this to turn the power ON/OFF and to disable button operation.

⑦ FF / ▼ button

Use to search forward to a playback position in a file and to select items.

⑧ MENU button

Use to open the Menu and to return to the screen open just before the Menu.

⑨ PLAY/PAUSE/ENTER button

Use to start/pause playback of recorded files and to confirm items.

■ Left and right sides

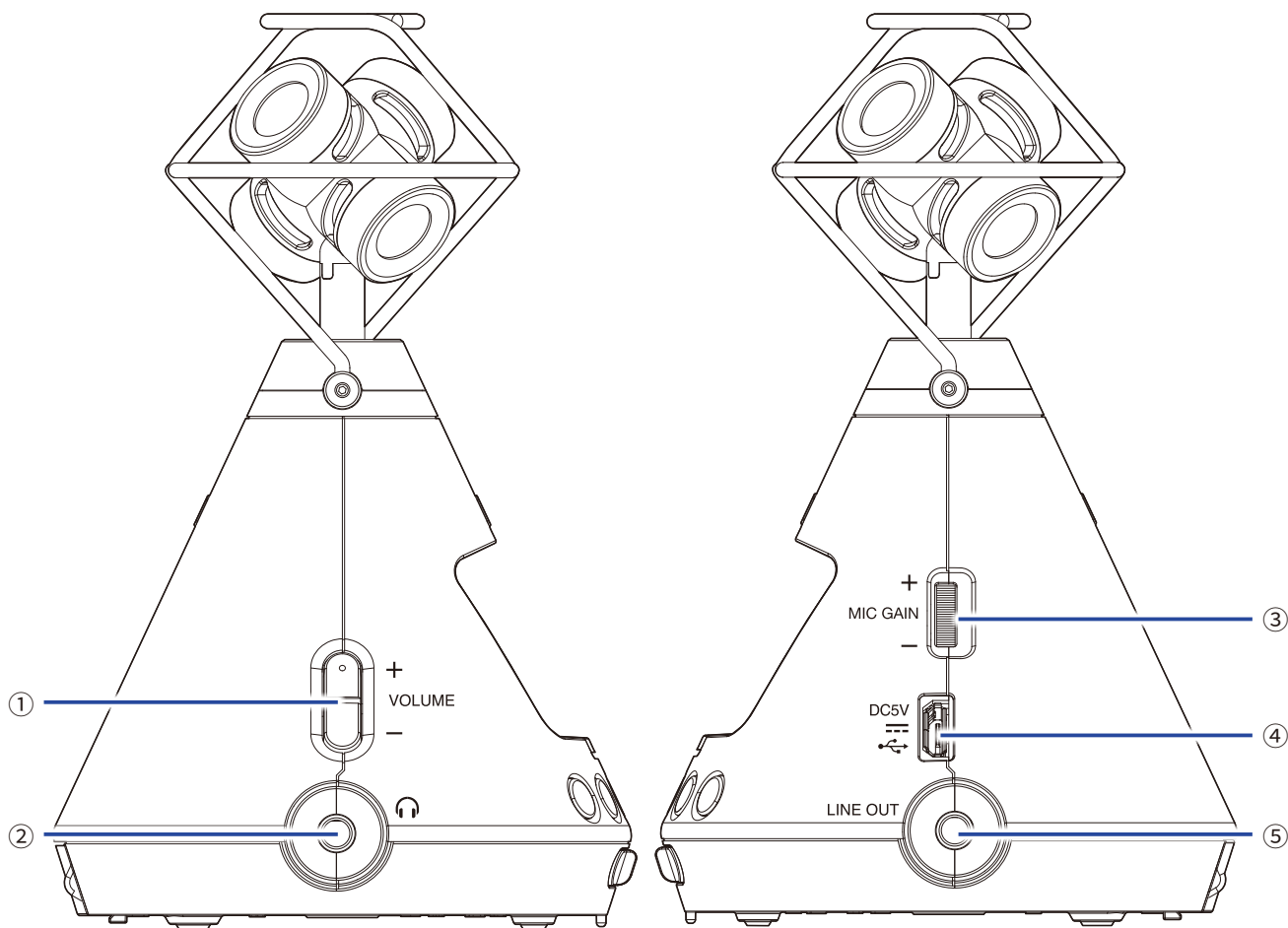

① VOLUME buttons

Use to adjust the volume.

② PHONE OUT jack

This can output sound to headphones.

③ MIC GAIN dial

Use to adjust the mic gain.

④ USB port

Connect this to a computer or iOS device to use the **H3-VR** as an audio interface or card reader. The dedicated AC adapter (ZOOM AD-17) can also be connected here to use AC power.

⑤ LINE OUT jack

This can output sound to a connected device.

■ Bottom

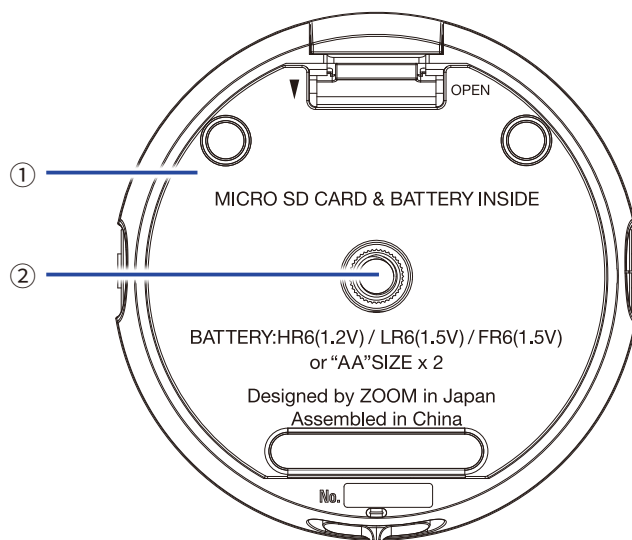

① **Battery/microSD card compartment cover**

Remove when installing or removing batteries and microSD cards.

② **Tripod mounting threads**

Use these screw threads to attach a tripod (not included).

Preparations

Supplying power

Using batteries

1. After turning the power off, push the battery/microSD card compartment cover down to open it.

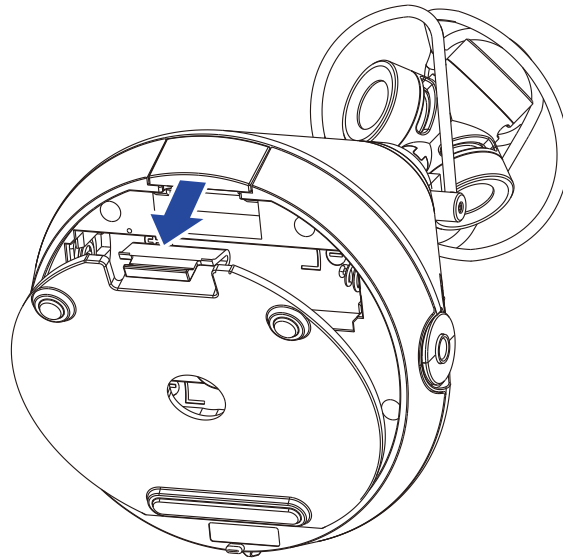

2. Install the batteries.

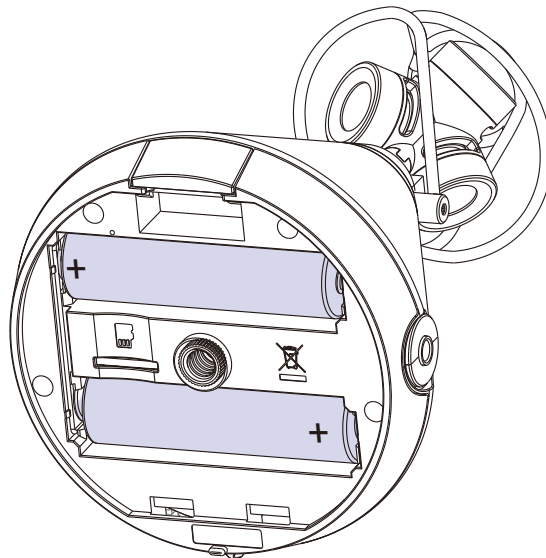

3. Close the battery/microSD card compartment cover.

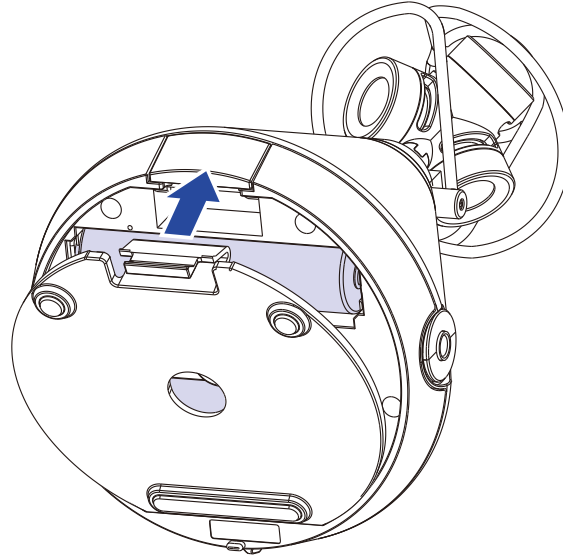

NOTE

- Use only one type of battery (alkaline, NiMH or lithium) at a time.
- If the remaining battery power indicator drops to 0, turn the power off immediately and install new batteries.
- After installing the batteries, set the battery type correctly (→ [“Setting the type of batteries used” on page 88](#)).

Using an AC adapter

1. Connect the cable of the dedicated AD-17 AC adapter to the USB port.

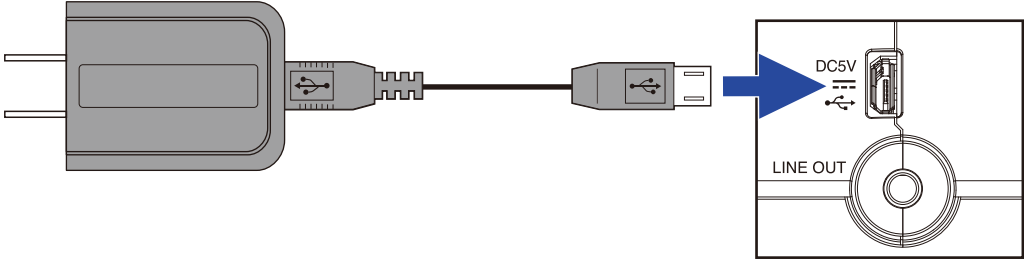

2. Plug the dedicated AC adapter into an outlet.

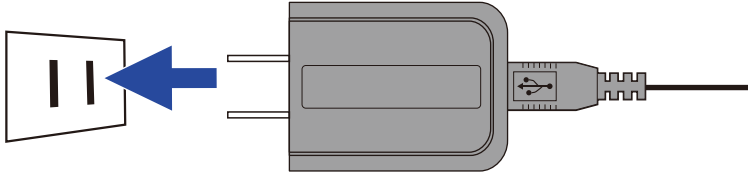

HINT

- When connected to a computer, power can be supplied by USB.
-

Inserting microSD cards

1. After turning the power off, push the battery/microSD card compartment cover down to open it.

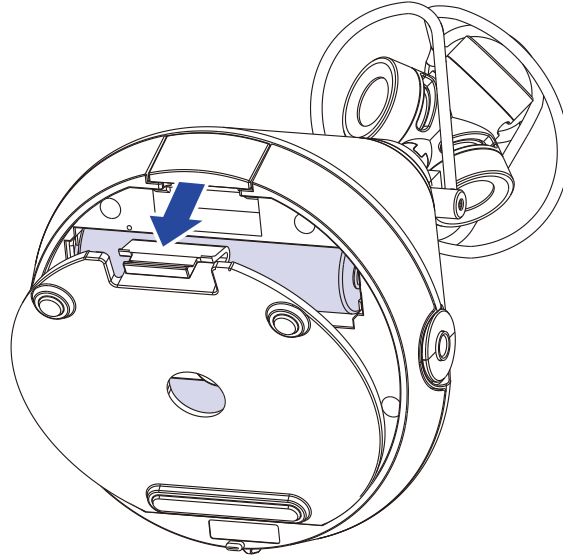

2. Insert the microSD card into the card slot.

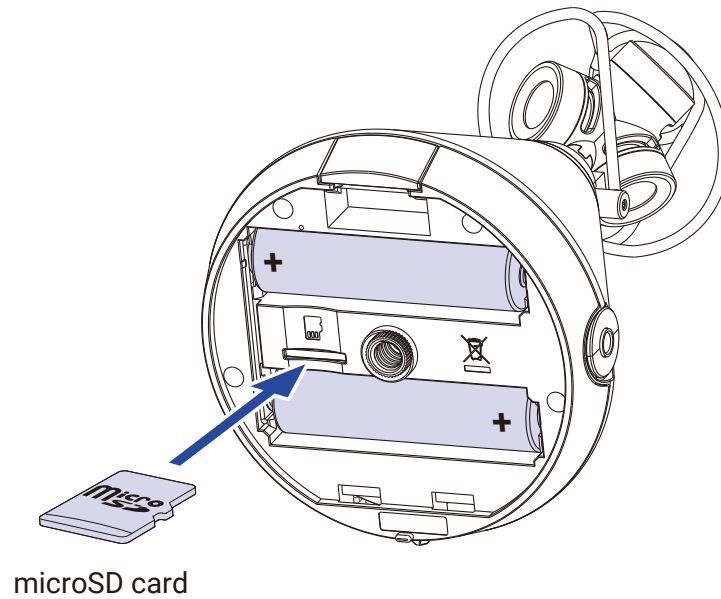

To remove a microSD card, push it further into the slot and then pull it out.

3. Close the battery/microSD card compartment cover.

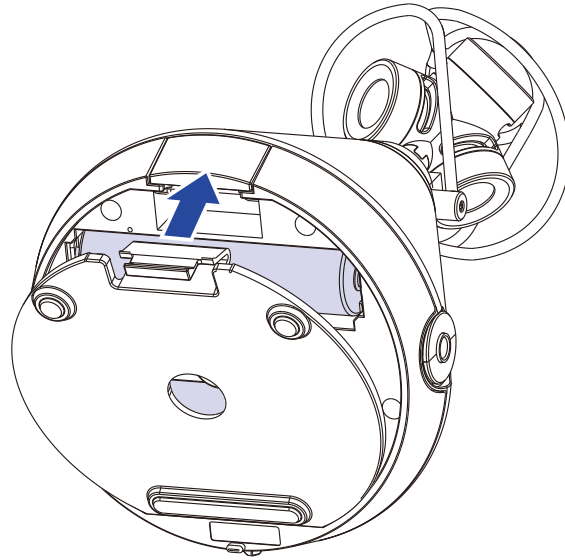

NOTE

- Always make certain that the power is off when inserting or removing a microSD card. Inserting or removing a card while the power is on could result in data loss.
- When inserting a microSD card, be sure to insert the correct end with the top side up as shown.
- Recording and playback are not possible when a microSD card is not loaded in the **H3-VR**.
- After purchasing a new microSD card, always format it using the **H3-VR** to maximize performance. To format a microSD card, see [“Formatting microSD cards” on page 98](#).

Turning the power on/off

Turning the power on

1. Slide the power switch toward  until the display becomes active.

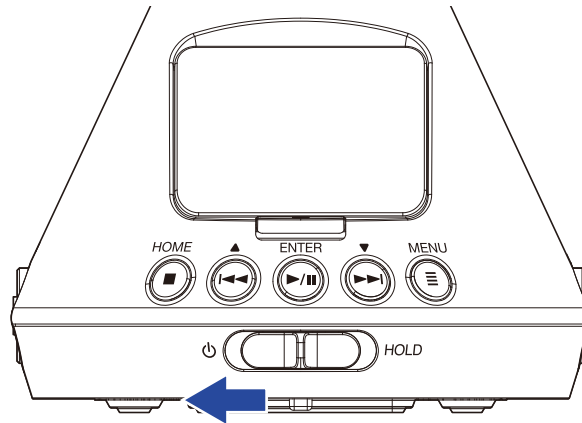

NOTE

- If “No SD Card!” appears on the display, confirm that a microSD card is inserted properly.
- If “Invalid SD Card!” appears on the display, the card is not formatted correctly. Format the microSD card (→ [“Formatting microSD cards” on page 98](#)) or use a different microSD card (→ [“Inserting microSD cards” on page 20](#)).

Turning the power off

1. Slide the power switch toward  until “Goodbye! See You!” appears on the display.

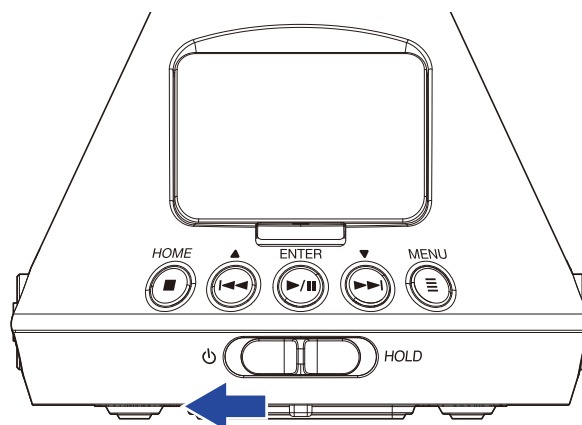

Preventing misoperation (HOLD function)

In order to prevent misoperation, the hold function can be used to disable the buttons on the **H3-VR**.

Activating the HOLD function

1. Slide the power switch to HOLD.

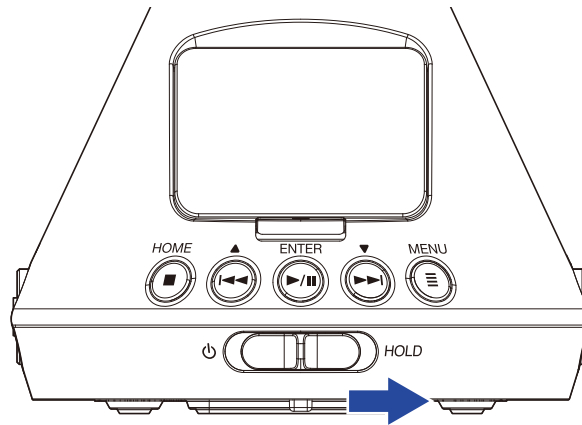



Deactivating the HOLD function

1. Slide the power switch back to the middle.

Setting the language shown (first time starting up)

The first time you turn the power on after purchase, set the display language when the Language setting screen opens.

1. Use  and  to select the display language, and press .

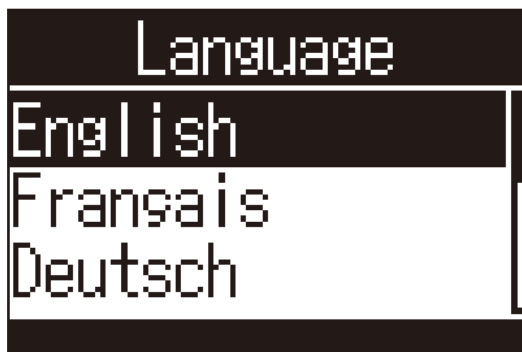



This completes setting the language.

HINT



- The display language can also be changed later from the Menu screen (→ [“Setting the language shown” on page 94](#)).
-

Setting the date and time (first time starting up)

The first time you turn the power on after purchase, set the date and time when the Set Date/Time screen opens after the Language setting screen. This data is used to add the date and time to recorded files.

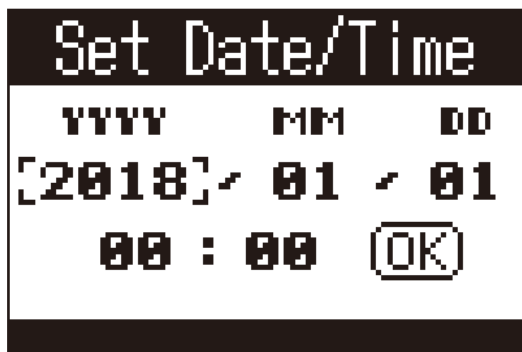
1. Use  and  to select the item to change, and press .



2. Use  and  to change the value of the selected item, and press .

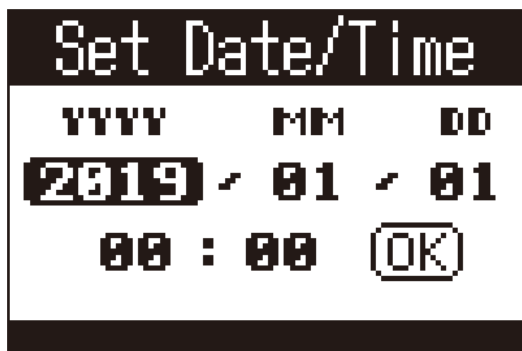

3. Use  and  to select "OK", and press .

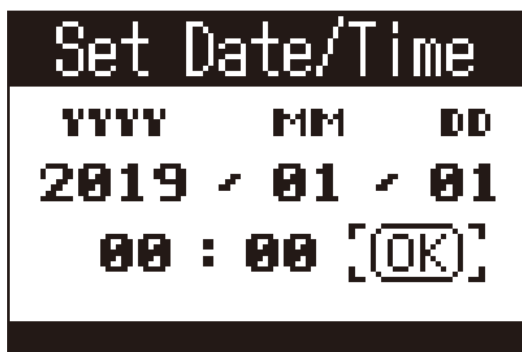

This sets the date and time and opens the Home Screen.

HINT

- The date and time setting can also be changed later from the Menu screen (→ ["Setting the date and time" on page 95](#)).

Recording

Home Screen (in recording standby)

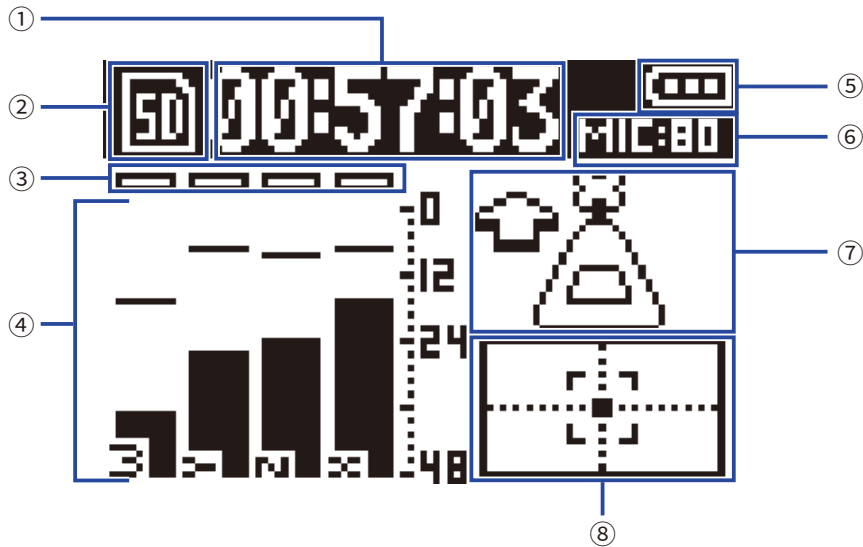

① Time display

This shows either the current elapsed recording time or the remaining available recording time (→ [“Setting the recording time display” on page 49](#)).

② Status icon

This shows the recording status.

Ready Recording Paused

③ Clipping indicators

If the clipping indicators light, adjust the input level (→ [“Adjusting input levels” on page 37](#)) or set the limiter (→ [“Setting the limiter” on page 40](#)).

④ Track names and level meters

These show the track names according to the recording mode (→ [“Setting the recording mode” on page 30](#)) and current input levels of each track.

⑤ Remaining battery charge

This shows the remaining battery charge. When the remaining battery charge becomes low, replace the batteries (→ [“Using batteries” on page 17](#)) or connect an AC adapter (→ [“Using an AC adapter” on page 19](#)).

⑥ Mic gain

This shows the current mic gain setting (→ [“Adjusting input levels” on page 37](#)).

⑦ Mic position

This shows the current mic position setting (→ [“Setting the mic position” on page 27](#)).

⑧ Tilt indicator

This shows mic tilt compared to the optimal mic position.

Preparing to record

Setting the mic position

The **H3-VR** can record sound in every direction, including forward, backward, left, right, up and down.

Use Mic Position to set the orientation of the mic and recorder in relation to the forward direction.

When Mic Position is kept at its default setting, which is Auto, the built-in motion sensor allows it to always record with normal forward/backward, left/right and up/down position relationships regardless of whether the mics are oriented up, down or forward.

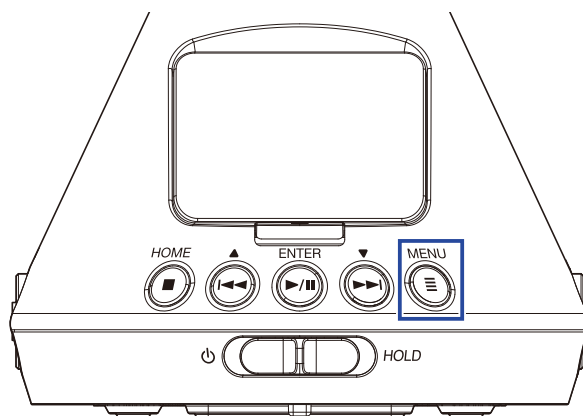

1. Press .

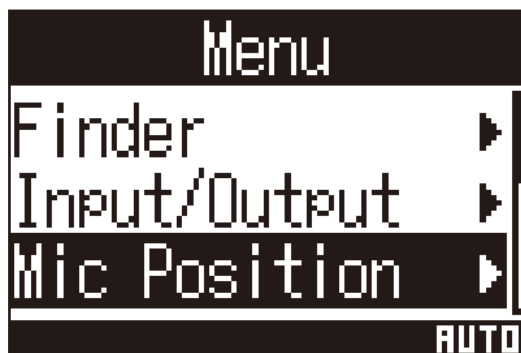

This opens the Menu Screen.

2. Use  and  to select "Mic Position", and press .



3. Use  and  to select the mic position, and press .

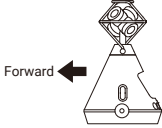
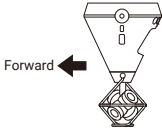
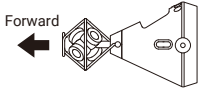
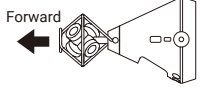

The following mic orientations can be set.

Setting	Mic/recorder orientation	Explanation
Auto	-	The H3-VR automatically sets the mic position according to its orientation at the start of recording.
Upright		Use this setting to record with the H3-VR upright.
Upside Down		Use this setting to record with the H3-VR upside down.
Endfire		Use this setting to record with the H3-VR oriented horizontally with its display up.
Endfire Invert		Use this setting to record with the H3-VR oriented horizontally with its display down.

The orientation of the **H3-VR** is detected by the motion sensor and shown on the Home Screen.

Adjust the angle of the **H3-VR** so that the tilt indicator is centered.

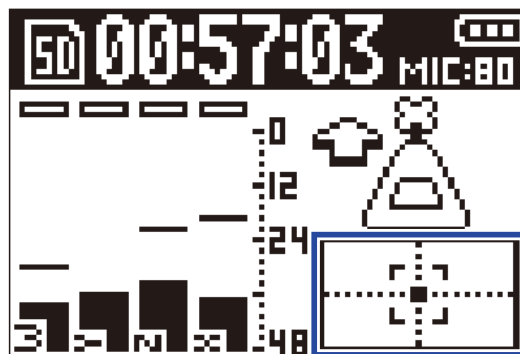

Tilt indicator

NOTE

- If the Mic Position setting and the mic orientation during recording are not the same, the recording file cannot be made the correct orientation and the front orientation will be off during playback.
- The Mic Position setting can be checked on the Home Screen.
- When the Mic Position setting is “Auto”, an animation will appear guiding you to orient the mic so that it matches the closest of the other four mic position settings. When the mic orientation approaches the correct angle, the tilt indicator will appear on the Home Screen.
- The Mic Position setting becomes fixed when recording starts. The Mic Position setting will not change during recording even if the mic orientation is changed.

HINT

- To minimize reflections, we recommend placing the **H3-VR** as far from walls and the floor as possible when recording.
-

Setting the recording mode

Set the file format used to record files.

1. Press .

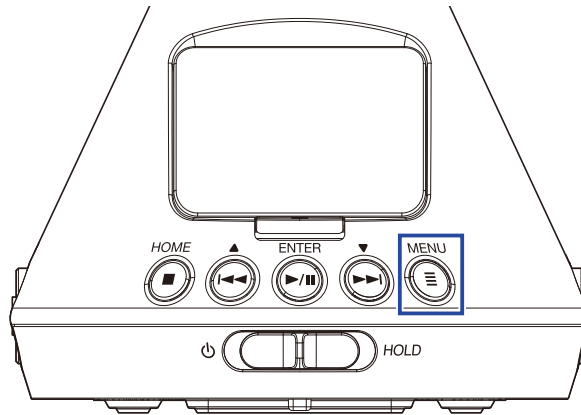

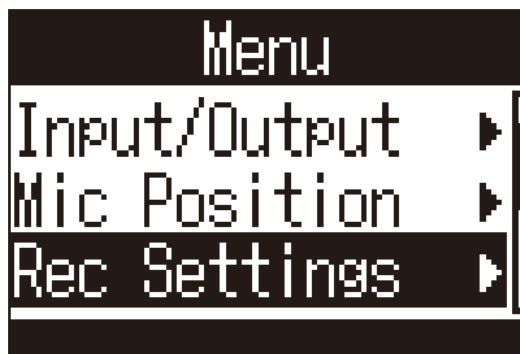

This opens the Menu Screen.

2. Use  and  to select "Rec Settings", and press .



3. Use  and  to select "Rec Mode", and press .



4. Use  and  to select the recording mode, and press .

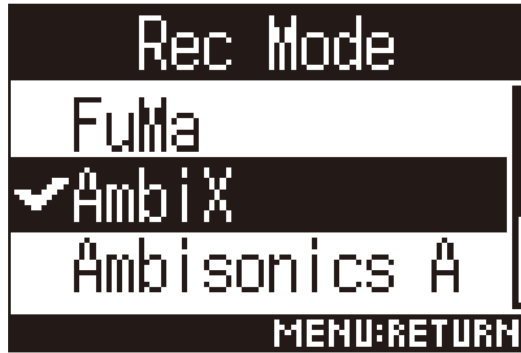

The following recording modes can be set.

Setting	Explanation
FuMa	Record as Ambisonics B FuMa format (4-channel).
AmbiX	Record as Ambisonics B AmbiX format (4-channel).
Ambisonics A	Record as Ambisonics A format (4-channel).
Stereo	Record as an ordinary stereo (2-channel) file.
Binaural	Record as a stereo (2-channel) file that has been converted to binaural.

NOTE

- "Binaural" cannot be selected when the recording format is "96k/16bit" or "96k/24bit".
- When using the **H3-VR** as an audio interface, "Rec Mode" cannot be set. Instead, the Menu can be used to set the following according to the audio interface mode.
Stereo: Binaural (Select "Off" for ordinary stereo or "On" for binaural.)
4ch Ambisonics: Ambisonic Mode (FuMa, AmbiX or Ambisonics A can be selected.)

HINT

- The recording mode used to record can be checked in the file information (→ ["Checking file information" on page 67](#)).

Setting the recording format

Set the sampling frequency (kHz) and bit rate (bit) in consideration of the audio quality and file size.

1. Press .

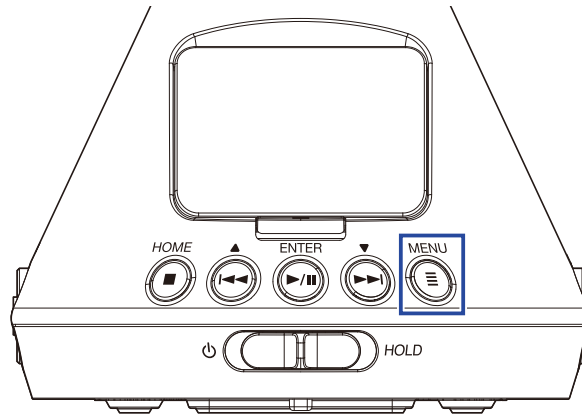

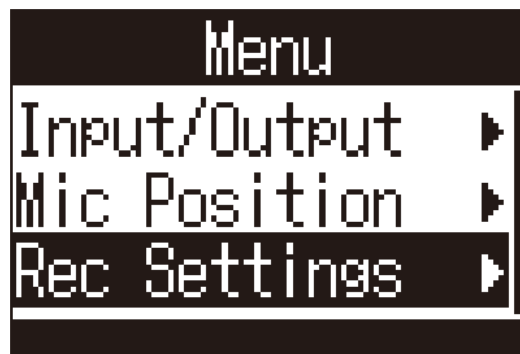

This opens the Menu Screen.

2. Use  and  to select "Rec Settings", and press .



3. Use  and  to select "Rec Format", and press .



4. Use  and  to select the recording format, and press .

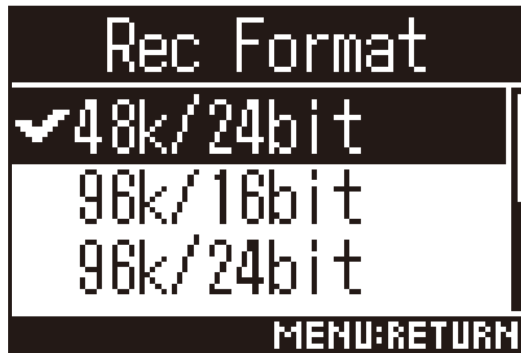

The recording formats that can be set are shown in order of audio quality (from low to high) and file size (from small to large).

Setting	Explanation
44.1k/16bit	The higher the sampling frequency (kHz) and bit rate, the better the audio quality.
44.1k/24bit	
48k/16bit	
48k/24bit	
96k/16bit	
96k/24bit	

NOTE

- When the recording format is "96k/16bit" or "96k/24bit", the "Binaural" recording (→ ["Setting the recording mode" on page 30](#)) and "Binaural" Ambisonic Monitoring (→ ["Setting Ambisonic monitoring" on page 35](#)) modes cannot be used.

Monitoring the input sound

Use headphones, for example, to monitor the input sound and adjust the volume.

1. Connect headphones, for example, to the PHONE OUT jack on the **H3-VR**.

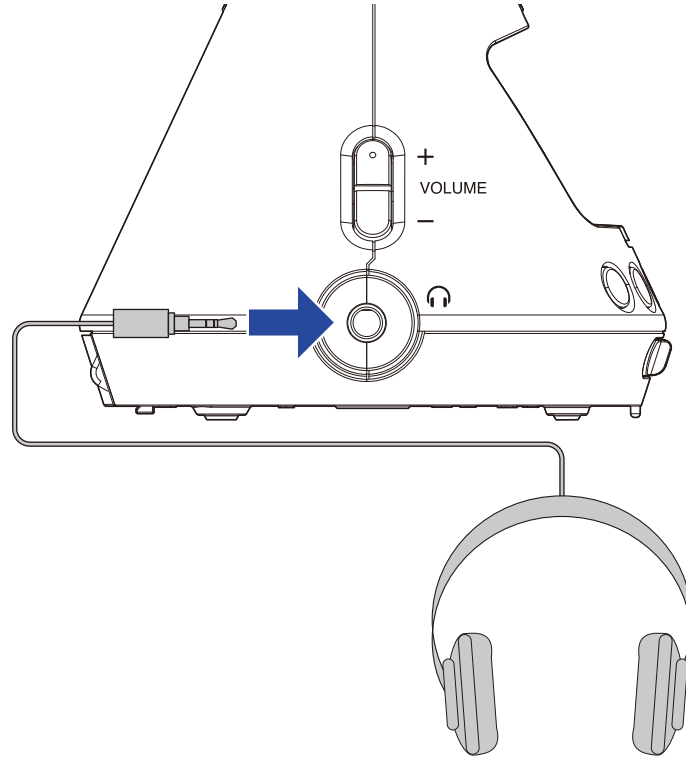

2. Use  to adjust the volume.





Setting Ambisonic monitoring

This sets the conversion format when outputting input signals from the PHONE OUT and LINE OUT jacks.

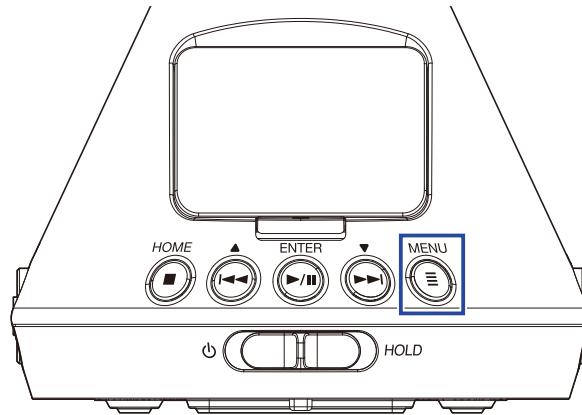
1. Press .





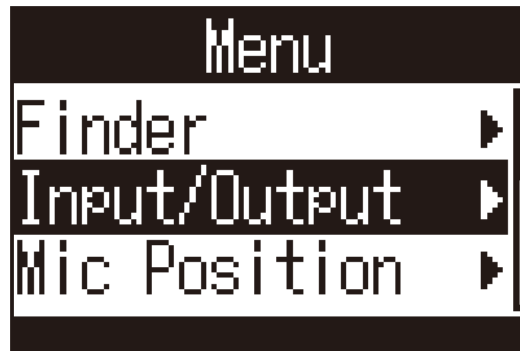

This opens the Menu Screen.

2. Use  and  to select "Input/Output", and press .

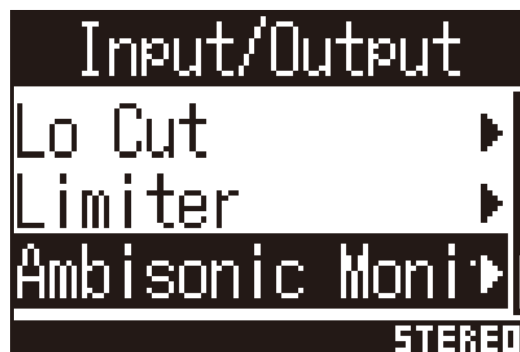

3. Use  and  to select "Ambisonic Monitor", and press .



4. Use  and  to select the Ambisonic monitoring mode, and press .



The following Ambisonic monitoring modes can be set.

Setting	Explanation
Stereo	The input sound is converted to ordinary stereo for monitoring.
Binaural	The input sound is converted to binaural for monitoring.

NOTE

- "Binaural" cannot be used when the recording format is "96k/16bit" or "96k/24bit".

Adjusting input levels

The input level used during recording can be adjusted.

1. Turn MIC GAIN  to adjust the input level.

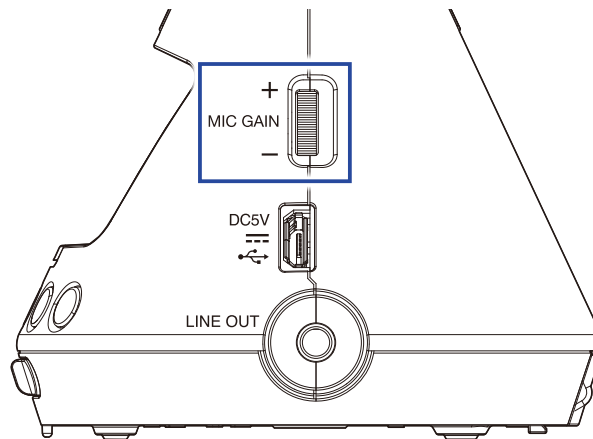

The changed input level is shown on the display.

Adjust so that peak levels on the level meters stay around -12 dBFS.

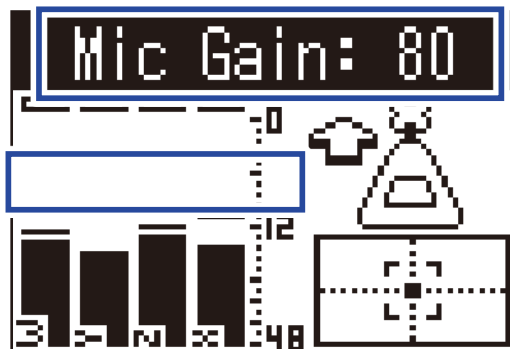

HINT

- Lower the input level if the clipping indicator lights because the sound could become distorted.
 - Press  to clear the clipping indicator.
-

Setting low-frequency cutoff filter

This function can reduce noise, including air-conditioning, wind and vocal pops.

1. Press .

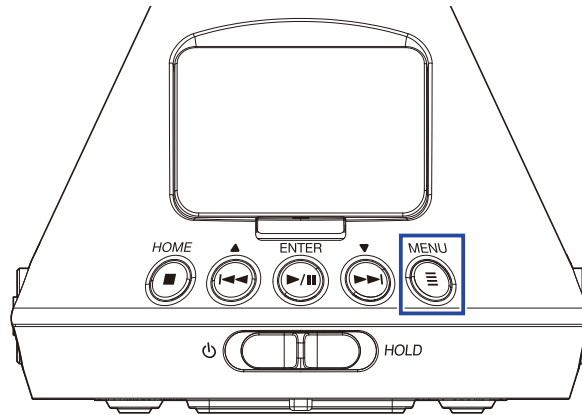

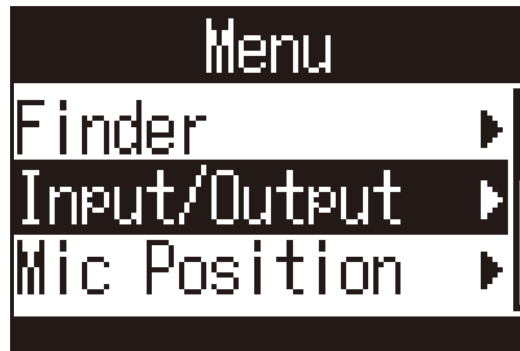

This opens the Menu Screen.

2. Use  and  to select "Input/Output", and press .

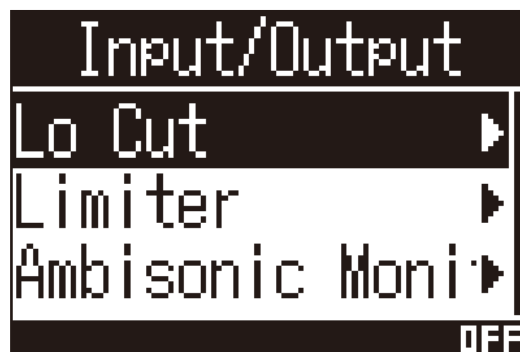

3. Use  and  to select "Lo Cut", and press .



4. Use  and  to set the cutoff frequency.



HINT

- This can be set from 10 to 240 Hz or Off.
-

Setting the limiter

The limiter can prevent distortion by reducing input signals that have excessively high levels.

When the limiter is ON, if the input signal level exceeds the set threshold value, the input signal level will be suppressed to prevent the sound from distorting.

The amount of time after the input signal exceeds the threshold until compression of the output signal is maximized is called the "attack time". The amount of time after the input signal goes below the threshold until the limiter stops compressing the signal is called the "release time". Change these two to adjust the audio quality.

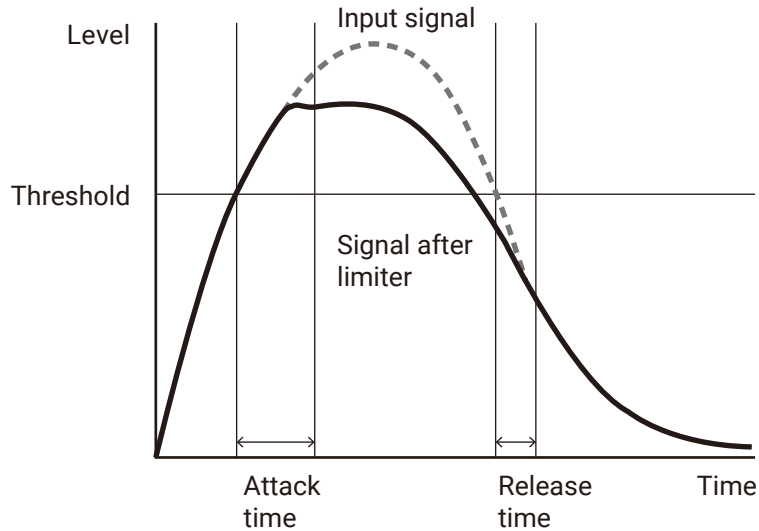

1. Press .

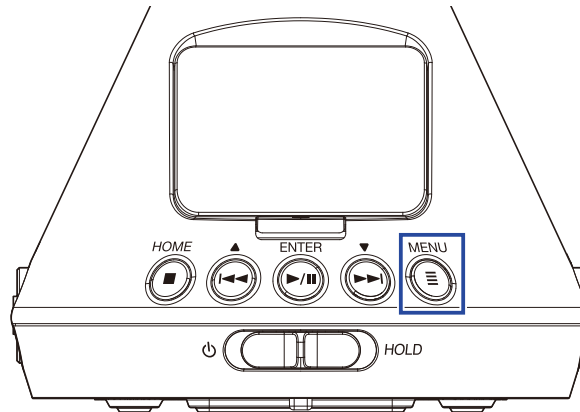

This opens the Menu Screen.

2. Use  and  to select "Input/Output", and press .

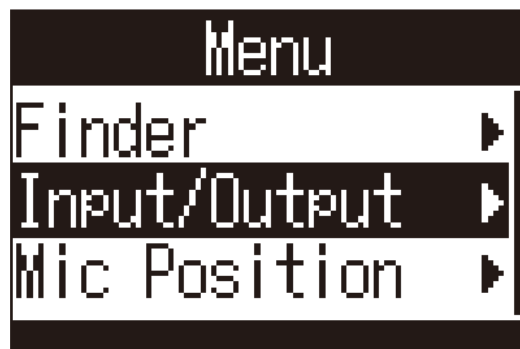

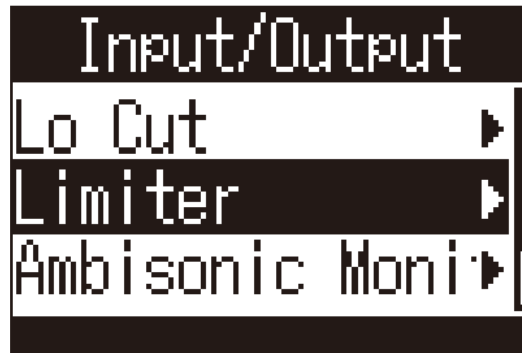

3. Use  and  to select "Limiter", and press .



■ Turning the limiter on

4. Use  and  to select "On/Off", and press .



5. Use  and  to select "On", and press .





HINT

- The ratio of compression used on the input signal is 20:1.
-

■ Setting the threshold

The threshold for limiter operation can be set.

4. Use  and  to select "Threshold", and press .

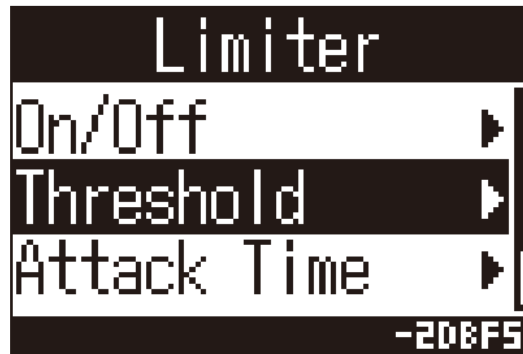

5. Use  and  to set the threshold.



HINT

- This can be set from -16 to -2 dBFS.
-

■ Setting the attack time

This sets the amount of time after the input signal exceeds the threshold until compression of the post-limiter signal is maximized.

4. Use  and  to select "Attack Time", and press .

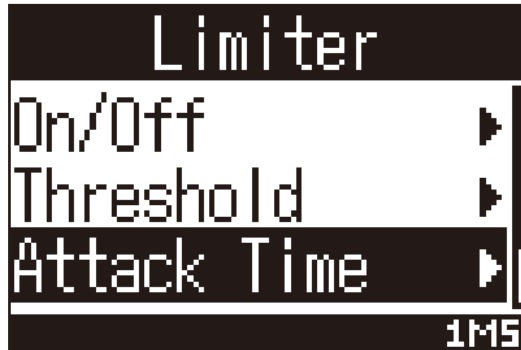

5. Use  and  to set the attack time.



HINT

- This can be set from 1 to 4 ms.
-

■ Setting the release time

This sets the amount of time until compression of the post-limiter signal stops after the input signal goes below the threshold.

4. Use  and  to select "Release Time", and press .



5. Use  and  to set the release time.



HINT

- This can be set from 1 to 500 ms.
-

Setting file names

This sets the file name used for recorded files.

1. Press .

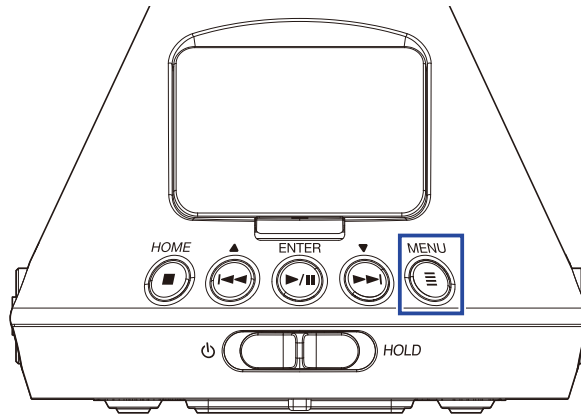



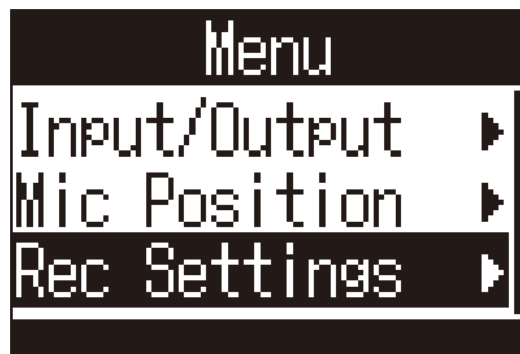

This opens the Menu Screen.

2. Use  and  to select "Rec Settings", and press .

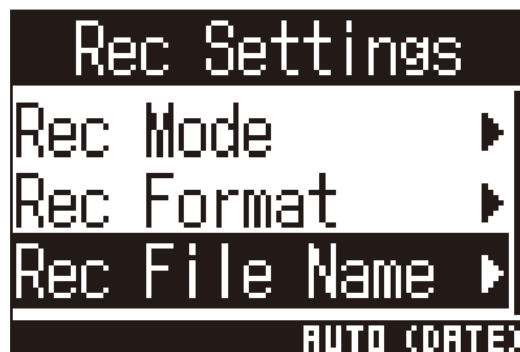

3. Use  and  to select "Rec File Name", and press .



4. Use  and  to select the file name format, and press .



The following file name formats can be used.

Setting	Explanation
Auto (Date)	Files are named with a "date_number" format. The "Date Format" setting will be used for the date (→ "Setting the date format" on page 97). Example: YYMMDD_001.WAV – YYMMDD_999.WAV
User Defined	Files are named with a "user input text string_number" format. Example: ZOOM_001.WAV – ZOOM_999.WAV

5. If "User Defined" was selected, input the text string to use for file names (→ ["Inputting characters" on page 87](#)).

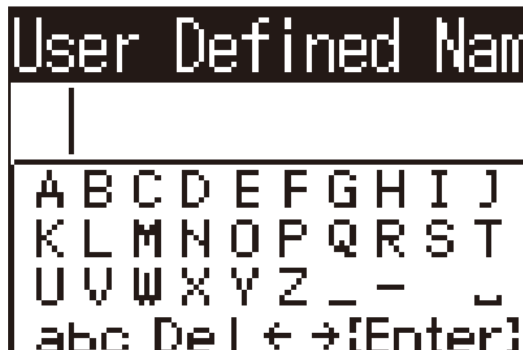

HINT

- If no character string is input, file names will be numbers only.

NOTE

- You cannot put a space at the beginning of a character string.

Enabling the sound marker function

Half-second tone signals (sound markers) can be output from the PHONE OUT and LINE OUT jacks when recording is started. Since sound markers are also written to recorded files, when recording audio for video with the **H3-VR**, adding tone signals to the camera audio can make synchronizing audio and video easier.

1. Press .

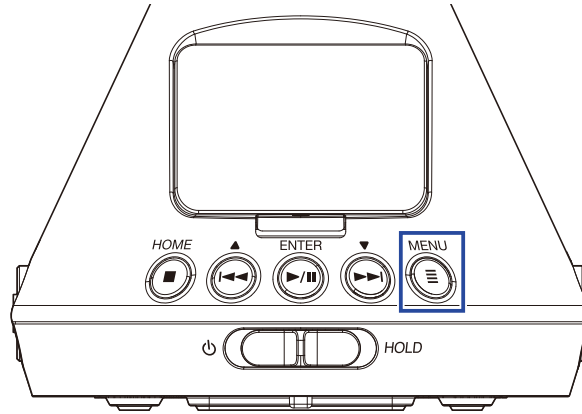





This opens the Menu Screen.

2. Use  and  to select "Rec Settings", and press .

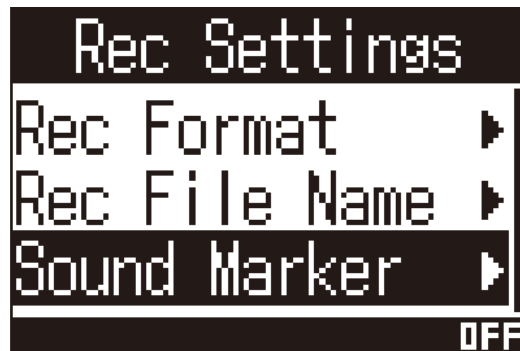

3. Use  and  to select "Sound Marker", and press .



4. Use  and  to select "On", and press .



NOTE

- Be careful with the volume if you are monitoring the input sound with headphones, for example.

Setting the recording time display

During recording, either the elapsed recording time or the remaining possible recording time can be shown.

1. Press .

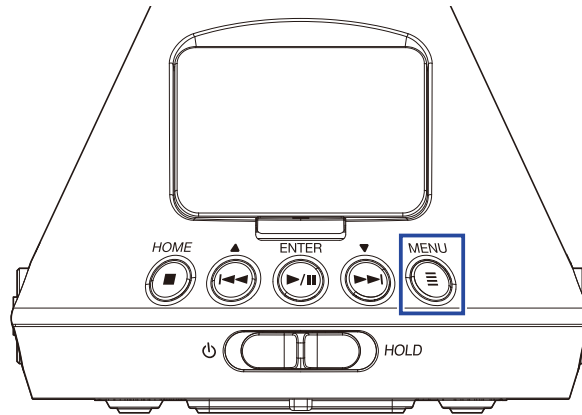

This opens the Menu Screen.

2. Use  and  to select "System", and press .

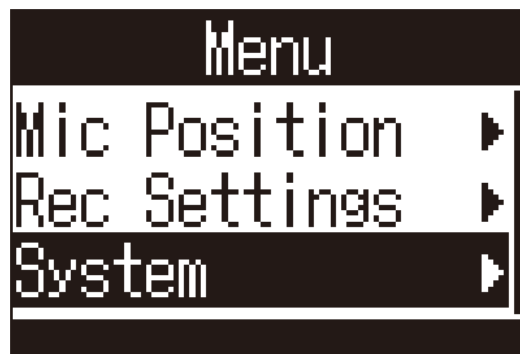

3. Use  and  to select "Time Display", and press .

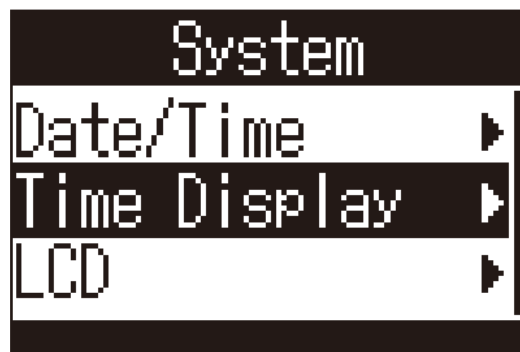

4. Use  and  to select "Recording", and press .

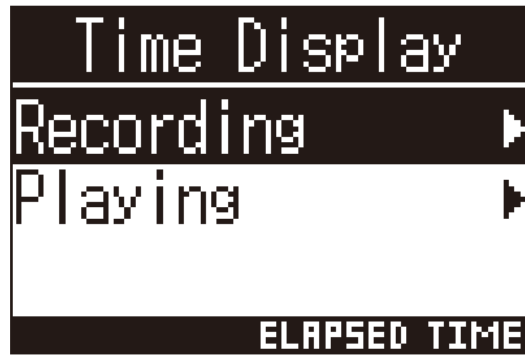

5. Use  and  to select "Elapsed Time" or "Remaining Time", and press .



Recording

1. Press  when the Home Screen is open.



The recording file name is shown and recording starts.



The following operation is possible during recording.

Function	Operation
Pause/resume	Press 

NOTE

- Marks are added at points where recording is paused. Marks are used as cue points. During playback, press  or  to move to a mark position.
- Up to 99 marks can be added to a single recording file.
- Marks can be deleted from the mark list (→ [“Deleting marks” on page 72](#)).
- If the file size exceeds 2GB during recording, a new file will be created automatically and recording will continue without pause.

1. Press .

This ends recording.

HINT

- Even if the power is interrupted or another problem occurs during recording, playing the recorded file with the **H3-VR** (→ [“Playing recordings” on page 52](#)) should repair it to a valid recording file.

Playback

The **H3-VR** has three playback modes: tracking, manual and binaural. The appearance of the display depends on the playback mode.

Playing recordings

1. Press  when the Home Screen is open.

This opens the Playback Screen and starts playback.

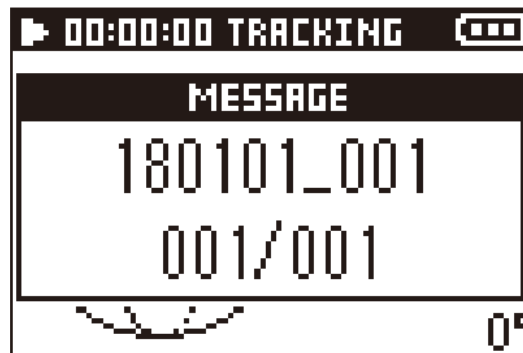

2. Press .

This ends playback.

HINT

- Use  to adjust the volume.
 - If there is no file that can be played back, a "No File!" message will appear.
-

Changing the playback mode

How audio is extracted from audio files recorded in Ambisonics A and Ambisonics B (FuMa and AmbiX) formats and how it is processed can be changed.

1. Press  during playback

Press repeatedly until the desired playback mode is selected.

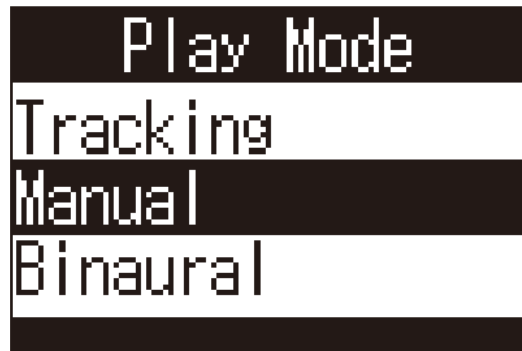

■ Tracking playback mode

By changing the orientation of the **H3-VR**, sound from specific directions can be extracted and played.

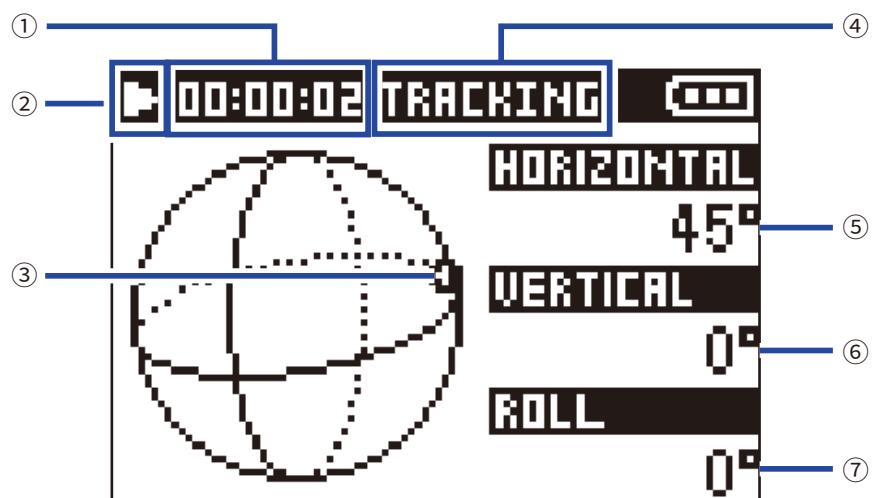







① Time display

This shows either the current elapsed playback time or the remaining playback time (→ [“Setting the playback time display” on page 58](#)).

② Status icon

This shows the playback status.

- | | |
|--|---|
|  Playing |  Playback paused |
|  Searching backward |  Searching forward |
|  Moving to previous file |  Moving to the next file |

③ Orientation of sound extracted

This shows the current orientation setting for sound extraction.

④ Playback mode

This shows the current playback mode setting.

⑤ **Horizontal angle**

This shows the horizontal angle of the extracted sound orientation.

⑥ **Vertical angle**

This shows the vertical angle of the extracted sound orientation.







⑦ **Roll angle**

This shows the roll angle (rotation) of the extracted sound orientation.



HINT

- The **H3-VR** detects changes in angles based on its orientation when playback started. We recommend placing the **H3-VR** on a flat surface, for example, before starting playback.
-



The following operations are possible during playback in tracking playback mode.

Function	Operation
Pause/resume	Press 
Search forward	Press and hold 
Search backward	Press and hold 
Move to the previous mark (if one exists) Move to the beginning of the file (if no mark exists)	Press 
Move to the next mark (if one exists) Play the next file (if no mark exists)	Press 
Play the previous file	Press  twice

HINT

- The longer you press and hold /, the faster the backward/forward search speed becomes.
 - If the selected file is not valid, an "Invalid File!" message will appear.
-

Manual playback mode

By using  to specify the horizontal angle and  to specify the vertical angle, sound from a specific direction can be extracted in stereo and played back.

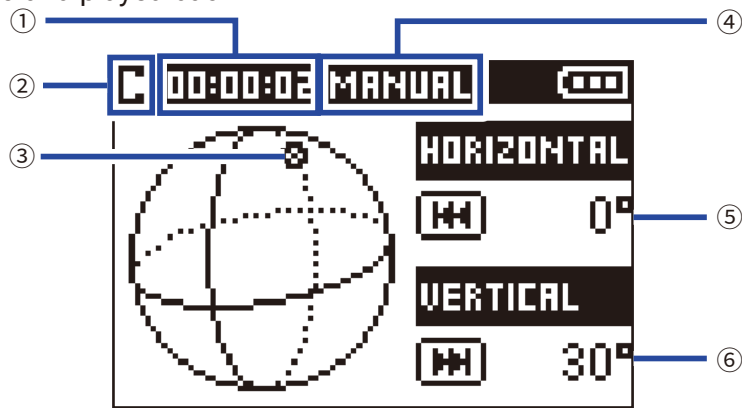

① Time display

This shows either the current elapsed playback time or the remaining playback time (→ [“Setting the playback time display” on page 58](#)).

② Status icon

This shows the playback status.

 Playing  Playback paused

③ Orientation of sound extracted

This shows the current orientation set for sound extraction.

④ Playback mode

This shows the current playback mode setting.





⑤ Horizontal angle

This shows the horizontal angle of the extracted sound orientation.

⑥ Vertical angle

This shows the vertical angle of the extracted sound orientation.

The following operations are possible during playback in manual playback mode.

Function	Operation
Pause/resume	Press  
Change horizontal angle	Press 
Change vertical angle	Press 

HINT

- The horizontal and vertical angles can be adjusted in 0–360° ranges.

■ Binaural playback mode

The sound can be converted to binaural and played back.

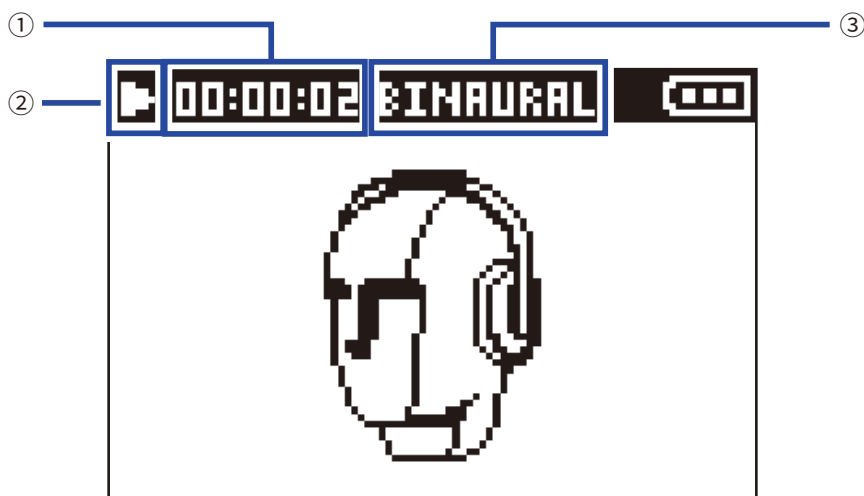

① Time display

This shows either the current elapsed playback time or the remaining playback time (→ [“Setting the playback time display” on page 58](#)).

② Status icon

This shows the playback status.

- | | |
|---------------------------|---------------------------|
| ▶ Playing | ⏸ Playback paused |
| ⏮ Searching backward | ⏭ Searching forward |
| ⏪ Moving to previous file | ⏩ Moving to the next file |







③ Playback mode

This shows the current playback mode setting.



NOTE

- Binaural mode playback is not possible with files recorded in "96k/16bit" or "96k/24bit" format.
- Files recorded in binaural mode will be played back without processing.

The following operations are possible during playback in binaural playback mode.

Function	Operation
Pause/resume	Press  
Search forward	Press and hold 
Search backward	Press and hold 
Move to the previous mark (if one exists) Move to the beginning of the file (if no mark exists)	Press 
Move to the next mark (if one exists) Play the next file (if no mark exists)	Press 
Play the previous file	Press  twice

HINT

- The longer you press and hold /, the faster the backward/forward search speed becomes.
- If the selected file is not valid, an "Invalid File!" message will appear.

Setting the playback time display

During playback, either the elapsed playback time or the remaining playback time can be shown.

1. Press .

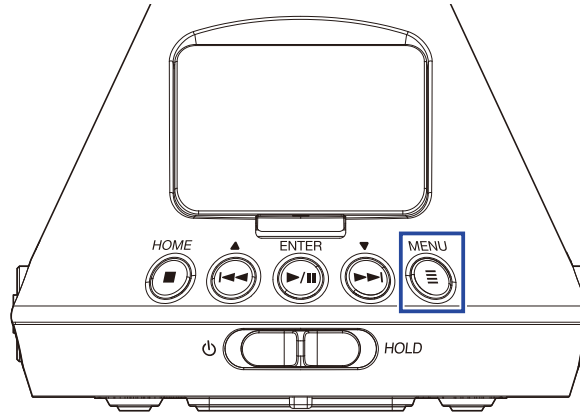

This opens the Menu Screen.

2. Use  and  to select "System", and press .

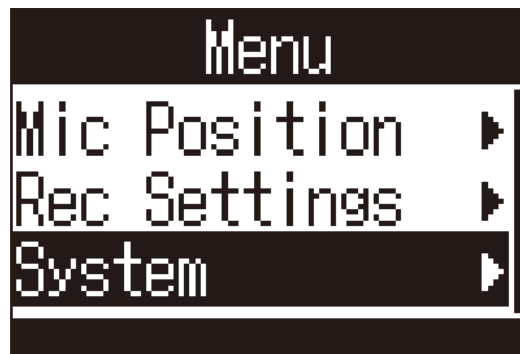

3. Use  and  to select "Time Display", and press .

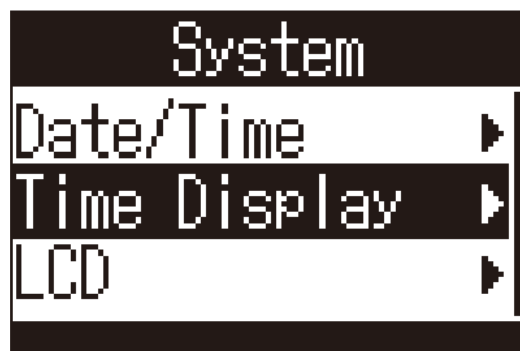

4. Use  and  to select "Playing", and press .

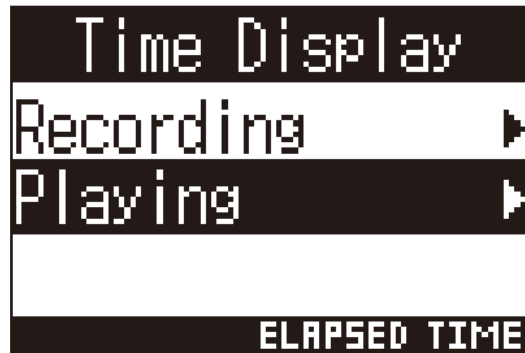

5. Use  and  to select "Elapsed Time" or "Remaining Time", and press .



Managing folders and files

Creating folders

Folders for saving recorded files can be created.

1. Press .

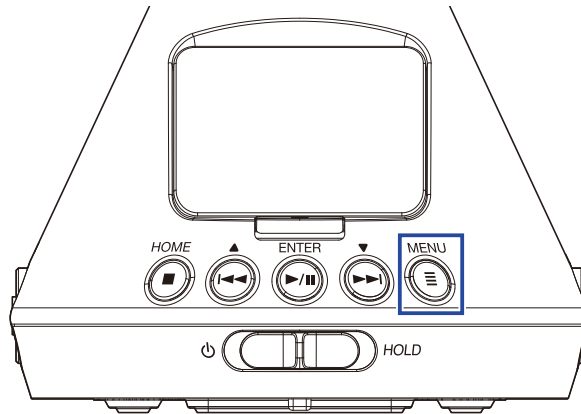

This opens the Menu Screen.

2. Use  and  to select "Finder", and press .

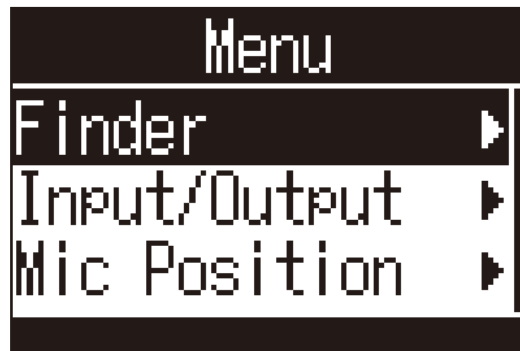

3. Use  and  to select "New Folder", and press .



4. Input the folder name (→ ["Inputting characters" on page 87](#)).



A new folder will be created.

Selecting folders and files

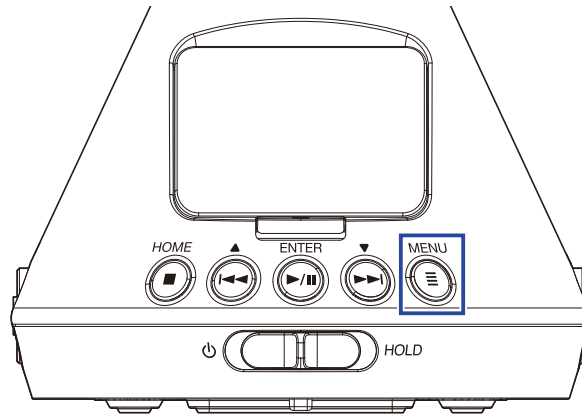

1. Press .



This opens the Menu Screen.

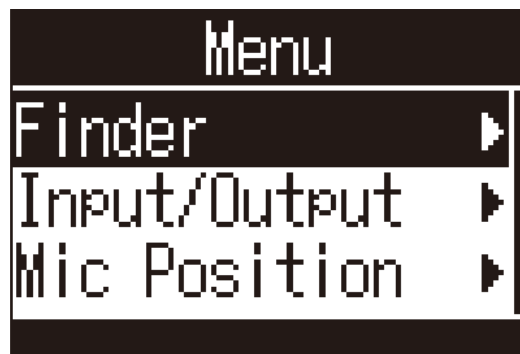



2. Use  and  to select "Finder", and press .



3. Use  and  to select a folder or file.



The following operations are possible when using the Finder.

Function	Operation
Move down a level	Press  when a folder is selected
Move up a level	Press 
Show options	Press and hold 
Play a file	Press  when a file is selected

NOTE

- Check marks will appear on the file currently being played, the destination folder for recorded files and the folder where the file currently being played is saved.

HINT

- Playback operations are the same as usual when a file is played back from the Finder (→ ["Playback" on page 52](#)).

4. Press and hold .

5. Use  and  to select "Select", and press .

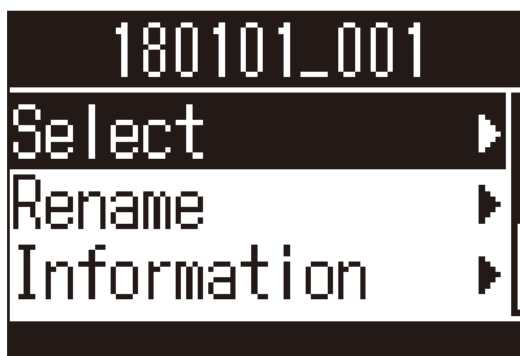

6. Use  and  to select "Execute", and press .

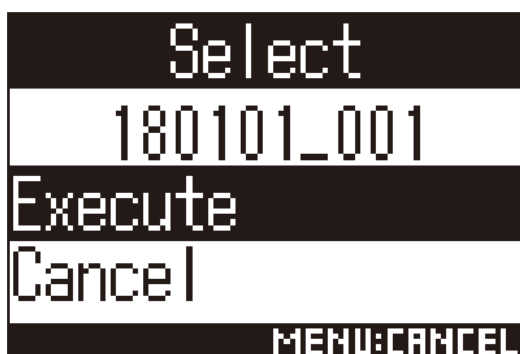

This selects the file or folder and opens the Home Screen.

HINT

- If an SD card or folder is selected, the first file inside it will be selected.
- “Select” shown inside an SD card or folder can be used to select that card or folder itself.

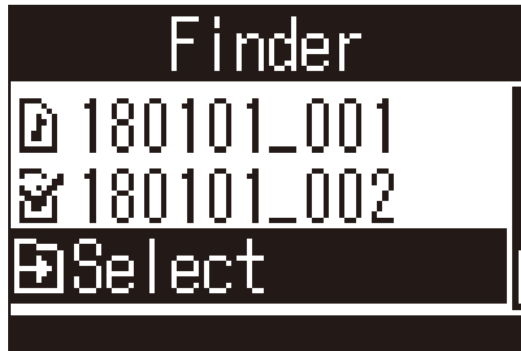

Changing folder and file names

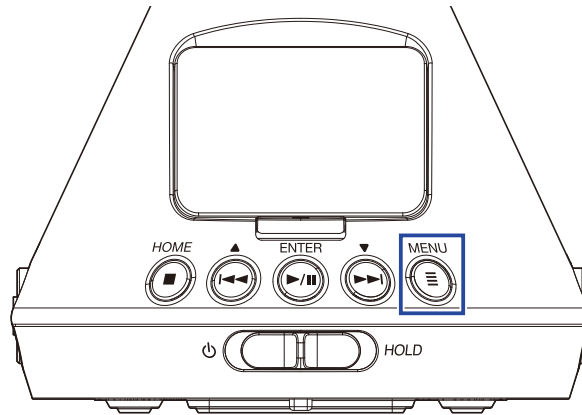

1. Press .



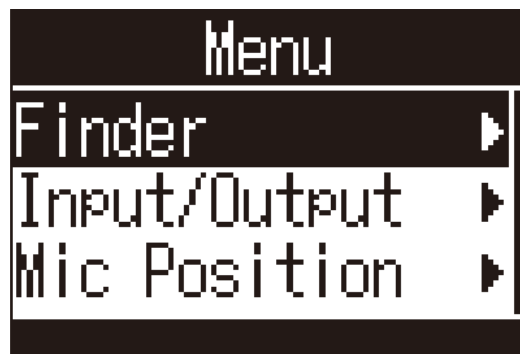

This opens the Menu Screen.

2. Use  and  to select "Finder", and press .



3. Use  and  to select the folder or file to change, and press and hold .



4. Use  and  to select "Rename", and press .

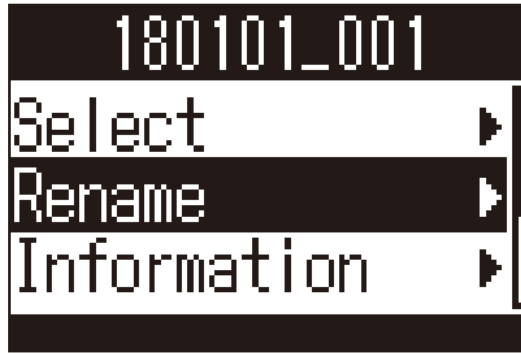

5. Change the folder or file name (→ ["Inputting characters" on page 87](#)).

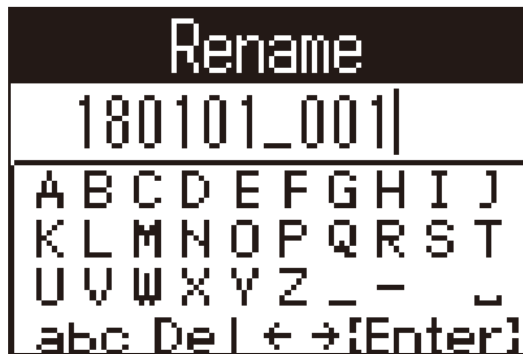

NOTE

- You cannot put a space at the beginning of a folder or file name.
- Folder and file names cannot be changed if they use characters other than ordinary (halfwidth) English letters and numbers.
- If a "File Number Reset!" message appears, the number used for recorded files has been reset.

Checking file information

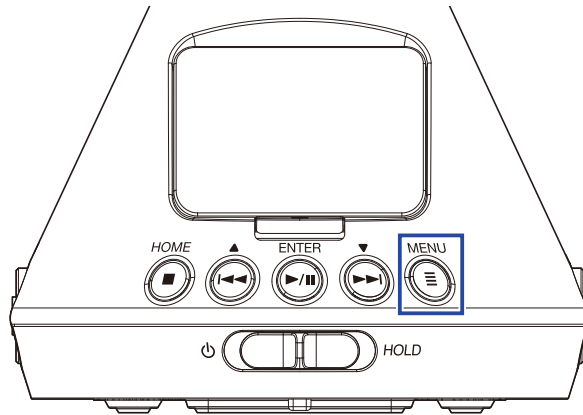

1. Press .

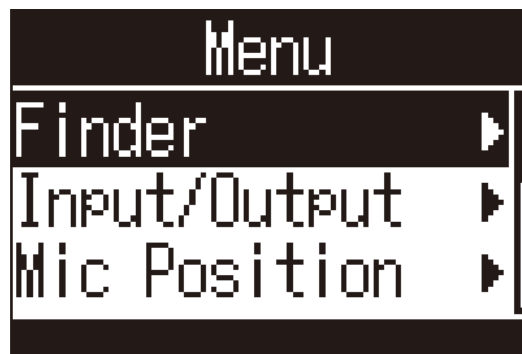

This opens the Menu Screen.

2. Use  and  to select "Finder", and press .





3. Use  and  to select the file to check, and press and hold .

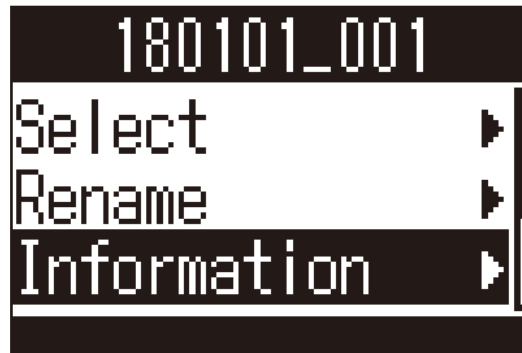

4. Use  and  to select "Information", and press .



5. Use  and  to check the file information.

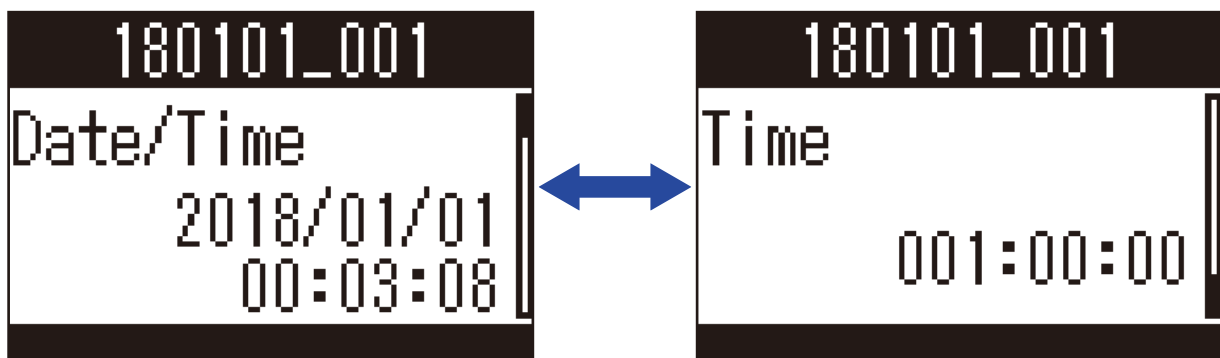

The following file information can be checked.

Item	Explanation
Date/time	Date and time recorded
Format	Recording format
Format	Recording mode and mic position
Size	Recording file size
Time	Recording time

NOTE

- The mic position will not be shown if the recording mode is "Binaural".

Checking file marks

You can view a list of the marks in a recording file. You can also start playback from the position of a selected mark.

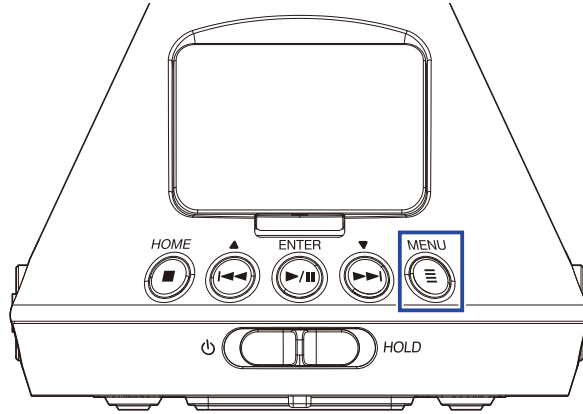

1. Press .

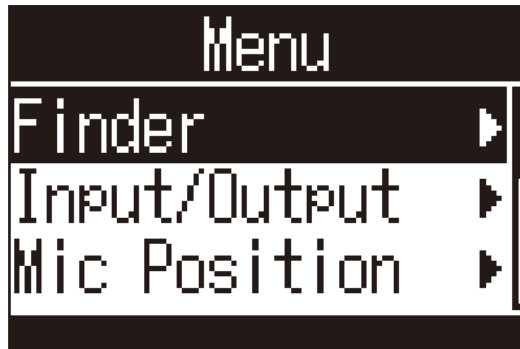

This opens the Menu Screen.

2. Use  and  to select "Finder", and press .



3. Use  and  to select the file, and press and hold .



4. Use  and  to select "Mark List", and press .

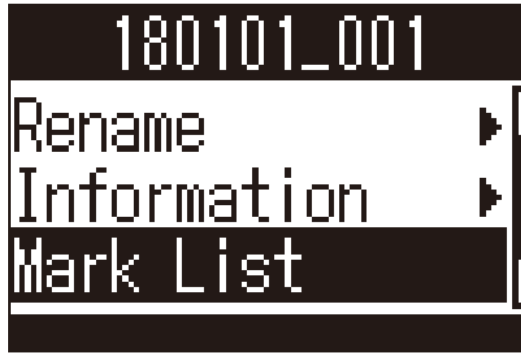

The marks are shown in a list.

5. To start playback from a specific mark, use  and  to select that mark, and press .





▶ Mark added when paused during recording

Ⓜ Mark added when skipping occurred during recording

6. Use  and  to select "Select", and press .



7. Use  and  to select "Execute", and press .

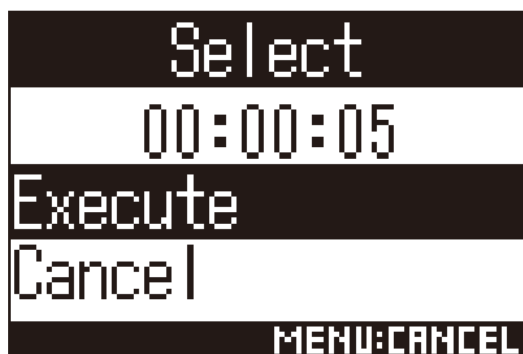

The Home Screen will reopen, and playback will start from the position of the selected mark.

Deleting marks

1. In the mark list, use  and  to select a mark, and press .



2. Use  and  to select "Delete", and press .



3. Use  and  to select "Execute", and press .



The selected mark will be deleted.

Deleting folders and files

1. Press .

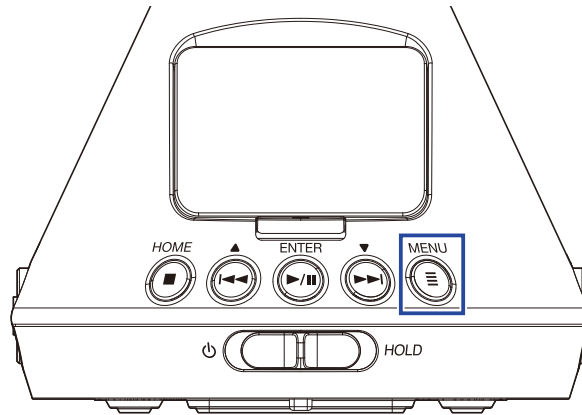

This opens the Menu Screen.

2. Use  and  to select "Finder", and press .

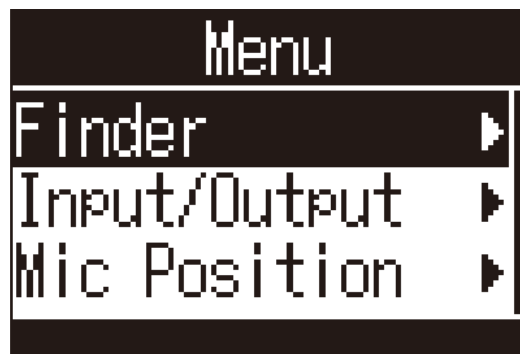



3. Press and hold .



4. Use  and  to select "Delete", and press .





5. Use  and  to select a file or folder to delete, and press .



A check mark appears on the selected file or folder.

HINT

- To delete multiple files and folders, repeat step 5.
 - By selecting "Select All" at the bottom of the list in step 5 and pressing , you can select/deselect all files and folders at once.
 - Press  to cancel deletion of files and folders.
-

6. Press and hold .

7. Use  and  to select "Execute", and press .



This deletes the selected files and folders.

Adjusting connected equipment levels (playing test tones)

The line output level can be adjusted.

Test tones can be played in order to adjust the level for a digital SLR camera or other device.

1. Minimize the input gain of the other device.
2. Use an audio cable to connect the external mic jack of the other device with the LINE OUT jack of the **H3-VR**.

3. Press .

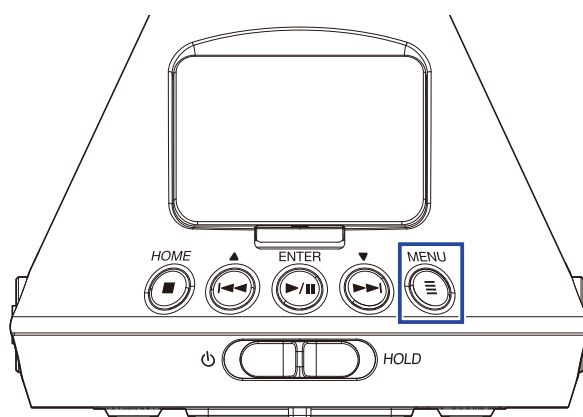

This opens the Menu Screen.

4. Use  and  to select "Input/Output", and press .

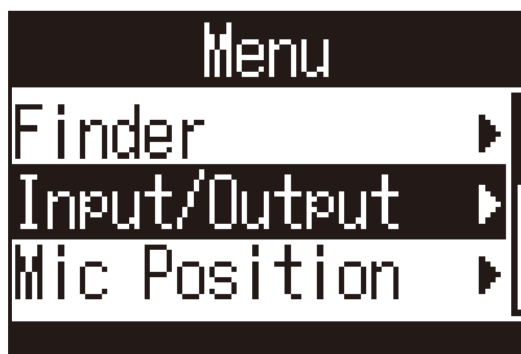

5. Use  and  to select "Line Out Level", and press .

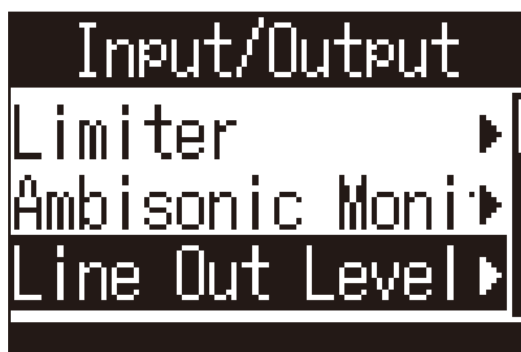

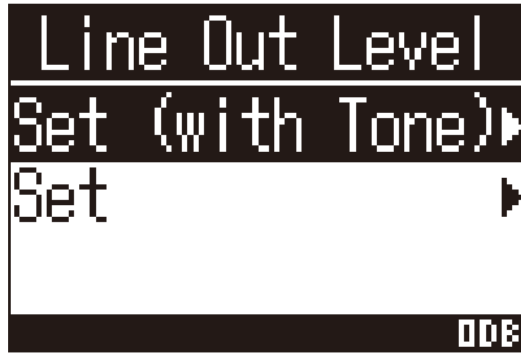

6. Use  and  to select "Set (with Tone)", and press .



This starts output of the test tone.

No test tone will be output if "Set" is selected.

7. Use  and  to adjust the line output level.

While checking the audio level meter of the other device, adjust the audio signal level so that it never exceeds -6 dB.

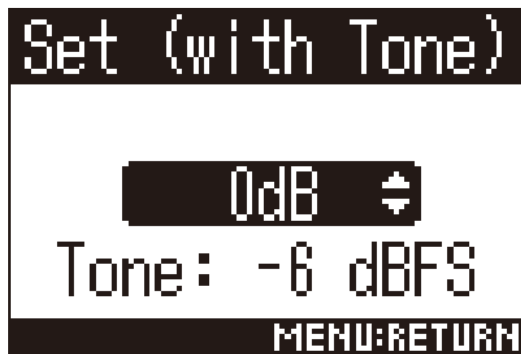

HINT

- This can be set from -40 to 0 dB.
-

8. Adjust the input gain of the other device.

While checking the audio level meter of the connected device, make adjustments to the input gain of that device until the audio signal level is about -6 dB.

9. Press .

This stops test tone output.

NOTE

- See the operation manual of the connected device being used for information about its operation.
- If the automatic gain control function on the other device is on, turn it off.
- The test tone is output from both the LINE OUT and PHONE OUT jacks.
- Be careful with the volume if you are monitoring the sound with headphones, for example.

HINT

- The test tone is a 1kHz sine wave at -6 dBFS.
-

Using USB functions

Using as a card reader

Use a computer to check the files saved on the microSD card and copy those files to the computer.

Connecting to a computer

1. Press .

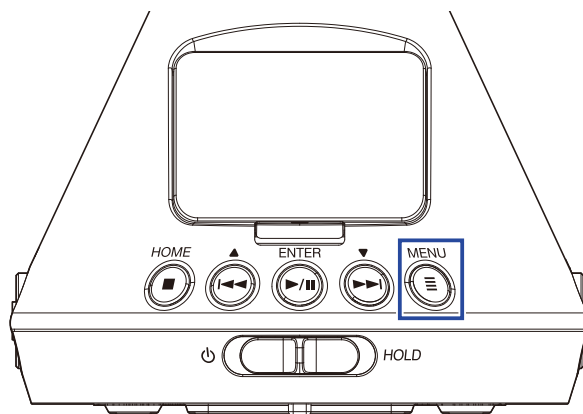

This opens the Menu Screen.

2. Use  and  to select "USB", and press .

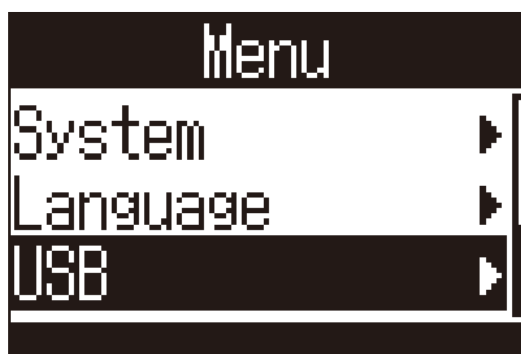

3. Use  and  to select "Card Reader", and press .



4. Use a USB cable to connect the **H3-VR** and the computer.

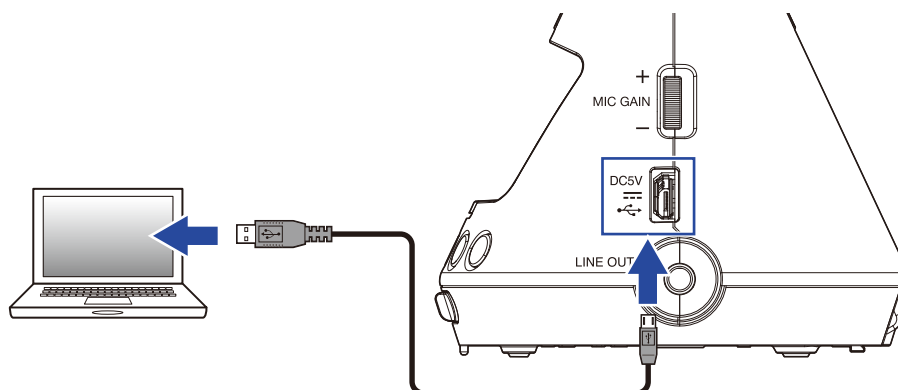

Disconnecting from a computer

1. Disconnect on the computer.

On Windows, select **H3-VR** from "Safely Remove Hardware".

On Mac operating systems, drag the **H3-VR** icon to the Trash and drop it.

NOTE

• Always conduct computer disconnection procedures before removing the USB cable.

2. Press .

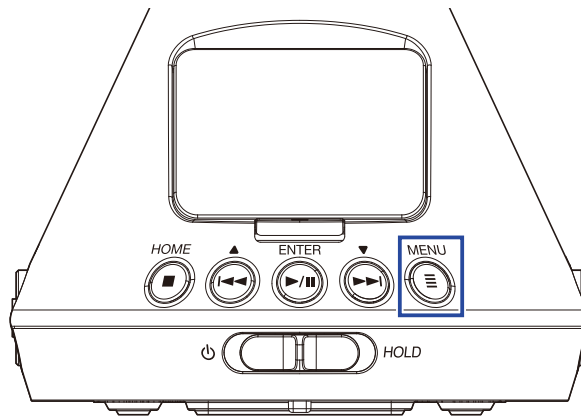

This opens the Menu Screen.

3. Use and to select "Exit", and press .



This ends card reader operation and reopens the Home Screen.

4. Disconnect the USB cable from the **H3-VR** and the computer.

Using as an audio interface

Sounds being recorded by the **H3-VR** can be input to a computer or iOS device, and playback signals on a computer or iOS device can be output from the **H3-VR**.

Connecting to a computer or iOS device.

1. Press .

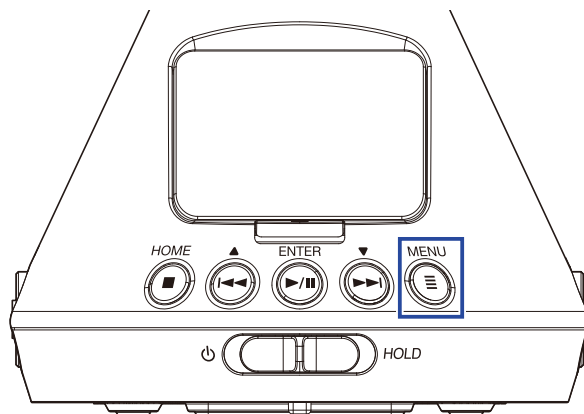

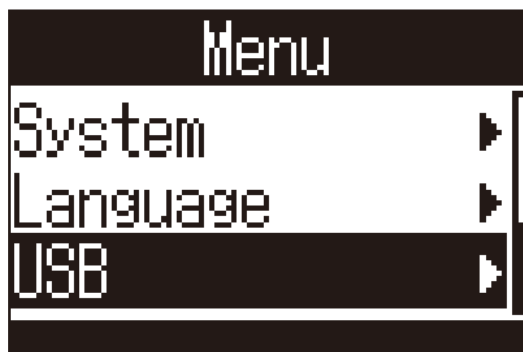

This opens the Menu Screen.

2. Use  and  to select "USB", and press .



3. Use  and  to select "Audio I/F", and press .



4. Use  and  to select the mode and type of connected device, and press .



The modes and devices that can be selected are as follows

Setting	Explanation
Stereo	Input signals 1–4 are sent as a stereo mix in this 2-in/2-out connection mode for Windows/Mac. The bus power of the connected device will be used.
4ch Ambisonics	Input signals 1–4 are sent as converted tracks 1–4 in this 4-in/2-out connection mode for Windows/Mac. To use with Windows, download the driver from the ZOOM website (www.zoom.co.jp). The bus power of the connected device will be used.
Stereo (iOS)	Input signals 1–4 are sent as a stereo mix in this 2-in/2-out connection mode for iOS devices. The H3-VR use its batteries for power.

5. Use a USB cable to connect the **H3-VR** and the other device.

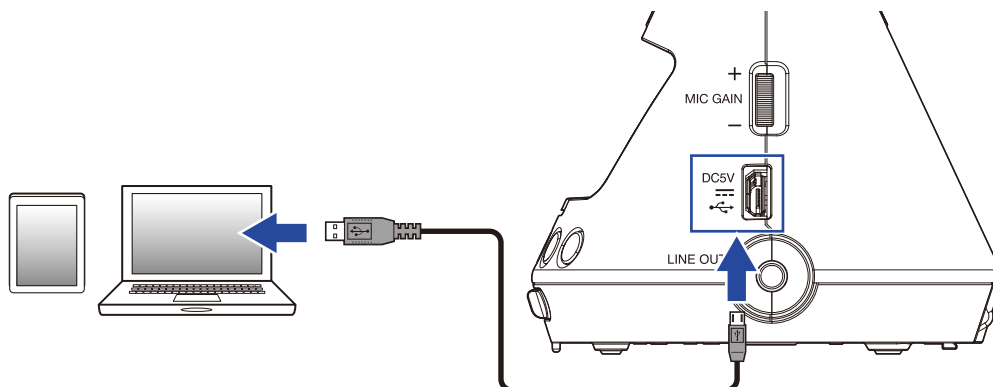

NOTE



- A Lightning to USB Camera Adapter is necessary to connect an iOS device.
- After selecting "Stereo (iOS)" in step 4, follow the instructions on the display and disconnect the cable once. Then, select "Stereo (iOS)" again and reconnect the cable.

Disconnecting from a computer or iOS device

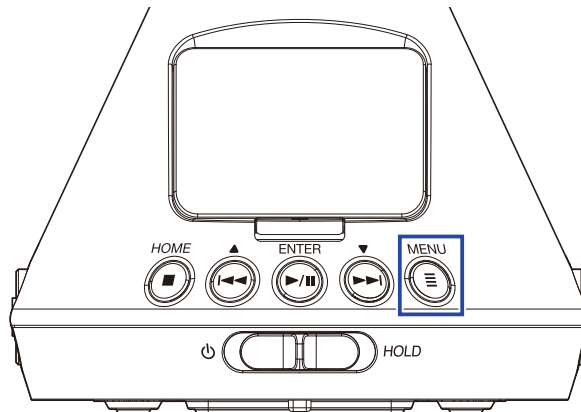
1. Press .



This opens the Menu Screen.

2. Use  and  to select "Exit", and press .

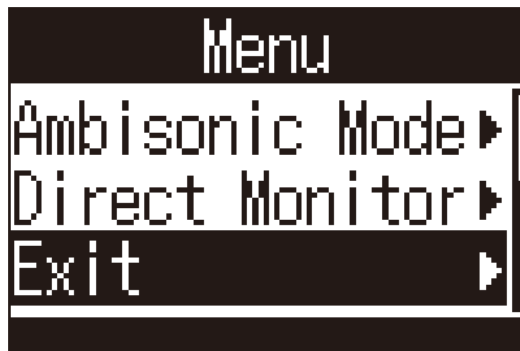

3. Use  and  to select "Execute", and press .

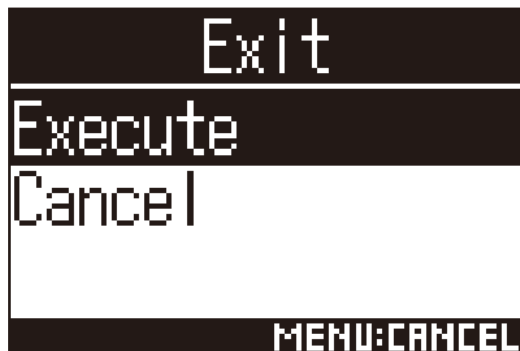

This ends audio interface operation and reopens the Home Screen.

4. Disconnect the USB cable from the **H3-VR** and the other device.

Audio interface settings

The following settings can be made when using the **H3-VR** as an audio interface.

Enabling direct monitoring

This directly outputs the sound being recorded by the **H3-VR** from it before sending it to the computer or iOS device. This enables monitoring without latency.

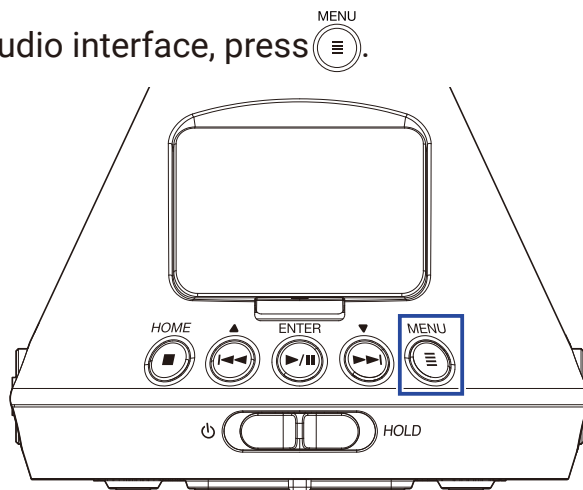

1. When connected as an audio interface, press .



This opens the Menu Screen.

2. Use  and  to select "Direct Monitor", and press .



3. Use  and  to select "On", and press .



This turns direct monitoring on.

Enabling the loop back function

This function mixes the playback sound from the computer or iOS device with the **H3-VR** input and sends the mix back to the computer or iOS device (loop back). You can use this function to add narration to music played back from the computer or iOS device and record the mix or stream it using software, for example.

NOTE

- This function cannot be used when the audio interface mode is "4ch Ambisonics".

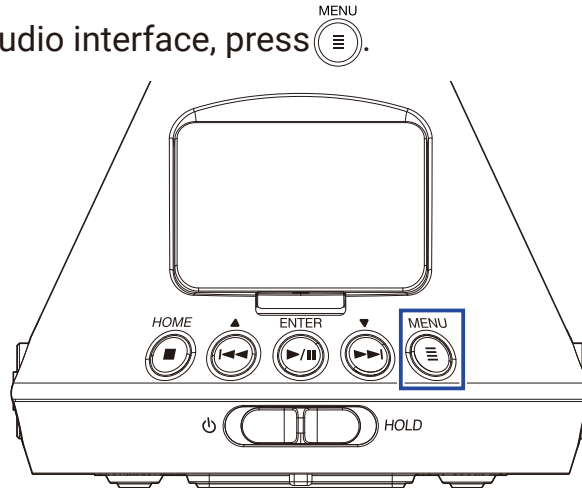

1. When connected as an audio interface, press .



This opens the Menu Screen.

2. Use  and  to select "Loop Back", and press .



3. Use  and  to select "On", and press .



This turns the loop back function on.

Operating with an iOS device

Pairing with an iOS device

By connecting a BTA-1 or other dedicated wireless adapter and using the dedicated controller app, the **H3-VR** can be operated from an iOS device.

NOTE

- The dedicated app must be installed on the iOS device beforehand. The dedicated app can be downloaded from the App Store.
- See the manual for the app for procedures to set and operate it.

1. Remove the REMOTE connector cover and connect a BTA-1 or other dedicated wireless adapter.

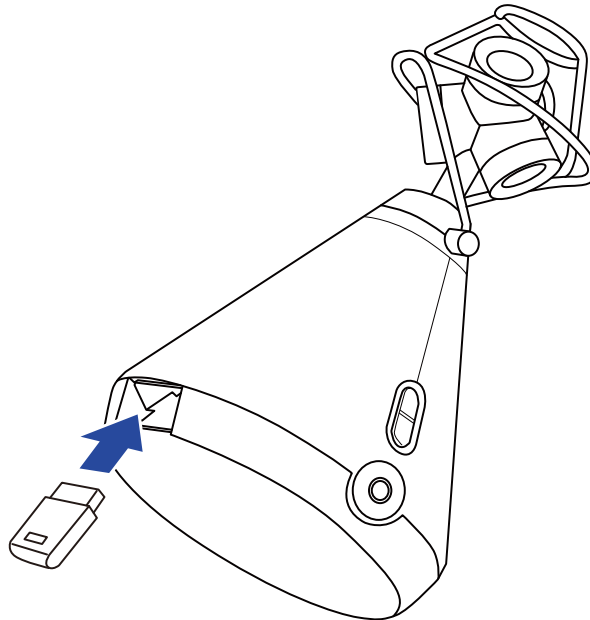

A password that is used to identify the BTA-1 or other dedicated wireless adapter will be shown.

2. Launch the dedicated app on the iOS device, and enter the password shown on the **H3-VR** display.

This starts pairing.

When pairing completes, "Connected" will appear on the **H3-VR** display.

HINT

- Entering a password will not be necessary when launching the app again in the future.
 - Use the **H3-VR** and the iOS device as close together as possible to make communication more reliable.
-



Disconnecting from an iOS device

Disconnecting the **H3-VR** and iOS device disables operation of the **H3-VR** from the iOS device.

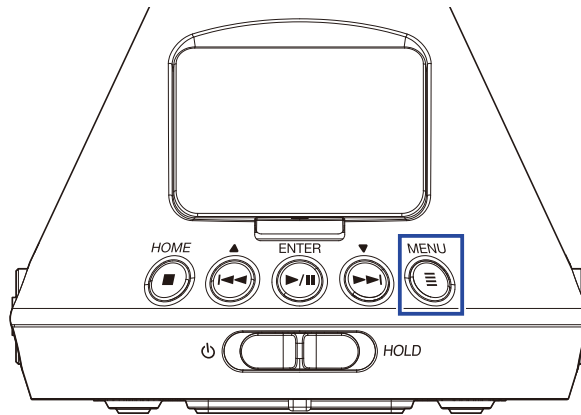
1. Press .



This opens the BTA-1 screen.

2. Use  and  to select "Off", and press .



HINT

- After disconnecting, to control the **H3-VR** with the iOS device again, select "BTA-1" from the Menu.
-

Inputting characters

A character input screen will open when you select a function that allows character input, including setting and changing file names.

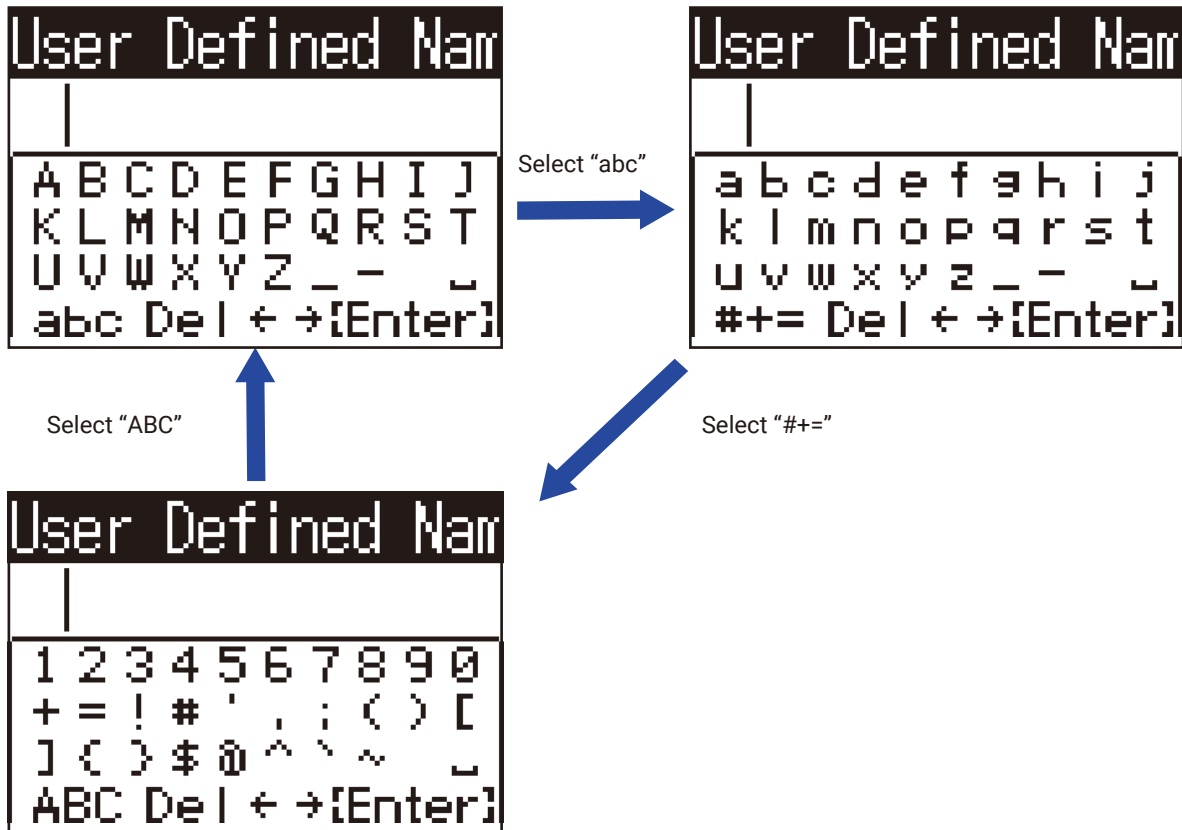

The following operations are possible on character input screens.

Function	Operation
Select characters	Use and .
Confirm characters	Press .
Change character type	Use and to select "abc", "#+=" or "ABC", and press . • When "abc" is selected, lowercase English letters can be input. • When "#+=" is selected, numbers and symbols can be input. • When "abc" is selected, uppercase English letters can be input.
Move the character input field cursor	Use and to select "←" or "→", and press .
Delete input characters	Use and to select "Del", and press .
End character input	Use and to select "Enter", and press .
Cancel character input	Press .

Setting the type of batteries used

Set the type of battery used by the **H3-VR** to alkaline, Ni-MH or lithium so that the amount of remaining battery charge can be accurately displayed.

1. Press .

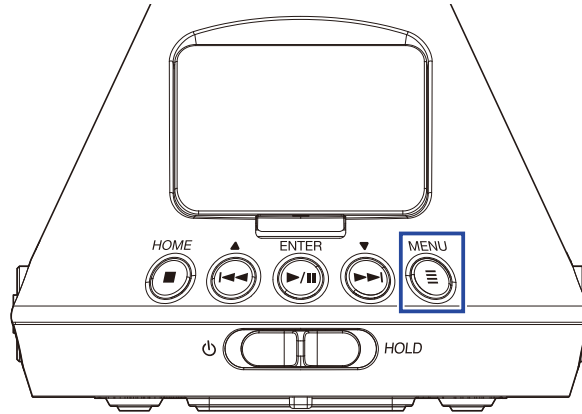



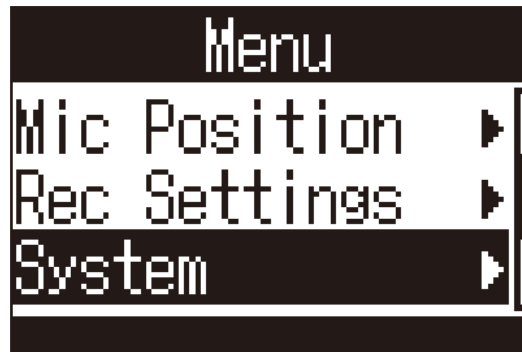

This opens the Menu Screen.

2. Use  and  to select "System", and press .

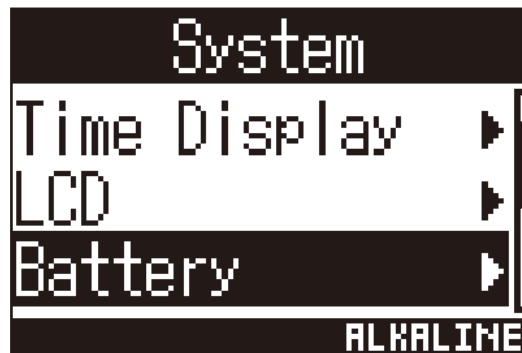

3. Use  and  to select "Battery", and press .



4. Use  and  to select the battery type, and press .

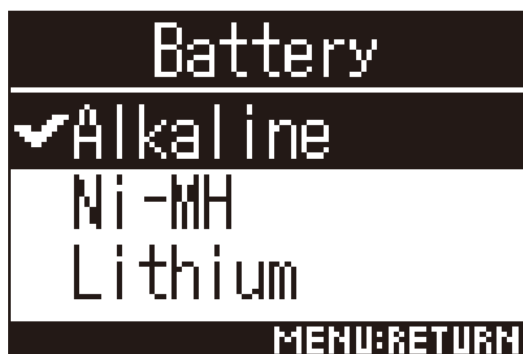

This sets the battery type.

Setting the display backlight

Set the time after the last operation until the display backlight turns off to conserve energy.

1. Press .

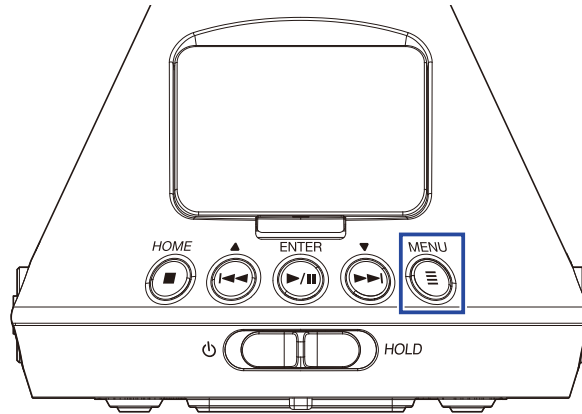

This opens the Menu Screen.

2. Use  and  to select "System", and press .

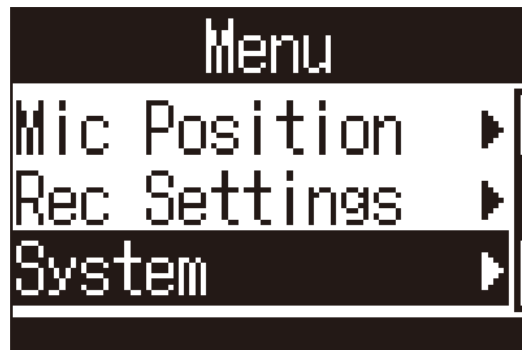

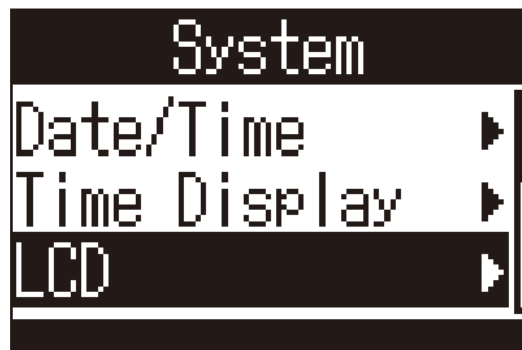

3. Use  and  to select "LCD", and press .



4. Use  and  to select "Backlight", and press .



5. Use  and  to set the amount of time until the backlight turns off, and press .



The following times to turn off the backlight can be set.

Setting	Explanation
Off	The backlight always stays off.
On	The backlight always stays on.
30 sec	The backlight turns off if no operation occurs for the set amount of time.
1 min	
2 min	
3 min	
4 min	
5 min	

Adjusting the display contrast

The contrast (display brightness level differences) can be set.

1. Press .

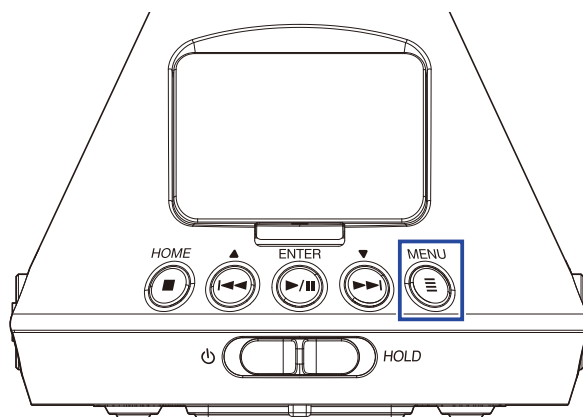



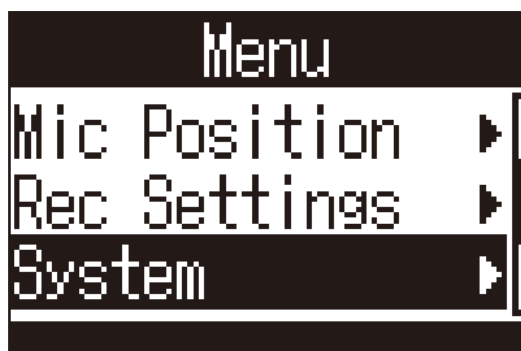

This opens the Menu Screen.

2. Use  and  to select "System", and press .

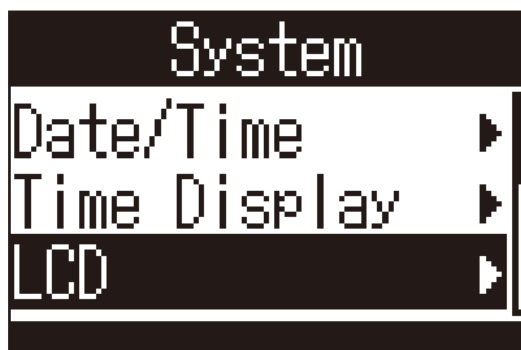



3. Use  and  to select "LCD", and press .



4. Use  and  to select "Contrast", and press .



5. Use  and  to set the display contrast.



This sets the contrast.

HINT

- This can be set from 1 to 10.
-

Setting the language shown

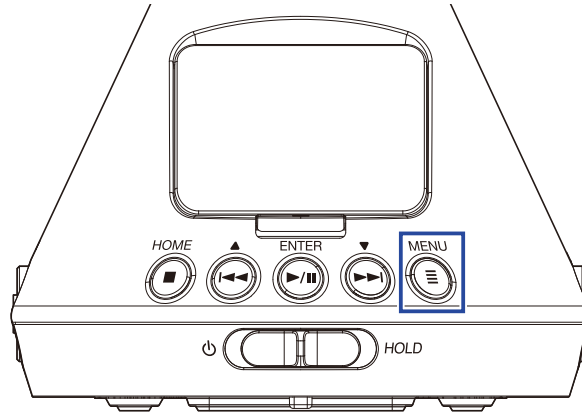

1. Press .



This opens the Menu Screen.

2. Use  and  to select "Language", and press .



3. Use  and  to select the display language, and press .



This completes setting the language.

HINT

- The first time you turn the power on after purchase, this screen opens automatically.
-

Setting the date and time

Set the date and time added to recording files.

1. Press .

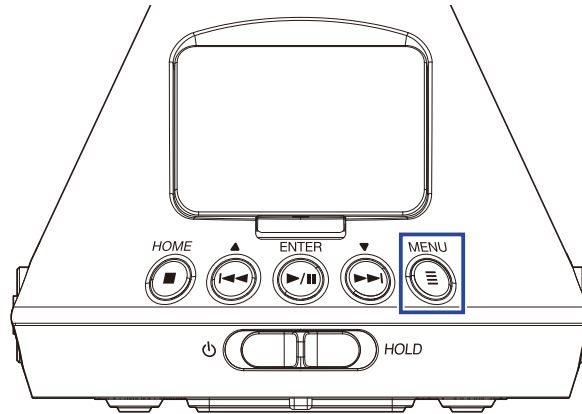

This opens the Menu Screen.

2. Use  and  to select "System", and press .

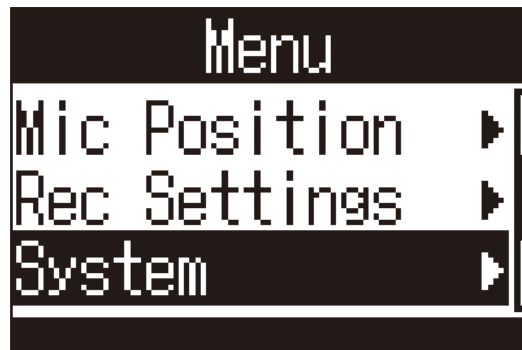

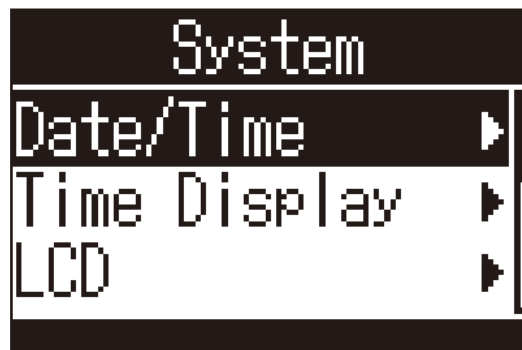

3. Use  and  to select "Date/Time", and press .



■ Setting the date and time

4. Use  and  to select "Set Date/Time", and press .





5. Use  and  to select the item to change, and press .



HINT

- The first time you turn the power on after purchase, this screen opens automatically after you set the language used.

6. Use  and  to change the value of the selected item, and press .



7. Use  and  to select "OK", and press .

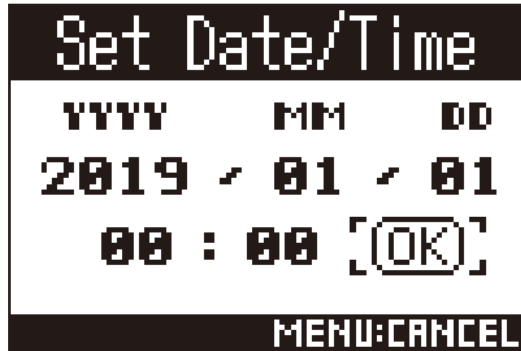



This completes setting the date and time.

Setting the date format

The date format can be changed. This is used when adding dates to file names and when showing the date on the display.

4. Use  and  to select "Date Format", and press .



5. Use  and  to select the date format, and press .

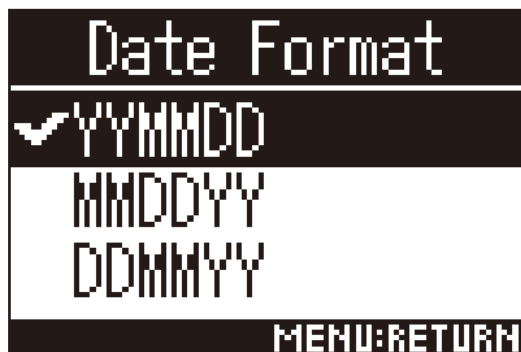

The following date formats can be used.

Setting	Explanation
YYMMDD	Year, month, day order
MMDDYY	Month, day, year order
DDMMYY	Day, month, year order

Formatting microSD cards

Format microSD cards to use them with the **H3-VR**.

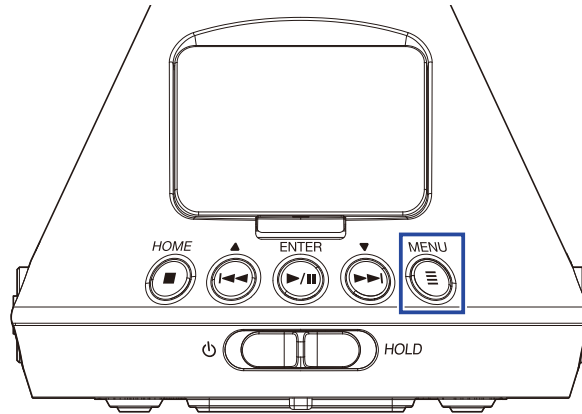

1. Press .

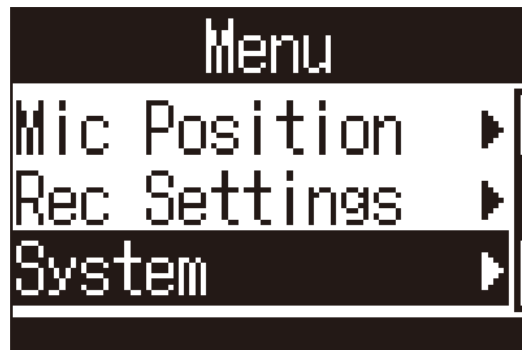

This opens the Menu Screen.

2. Use  and  to select "System", and press .



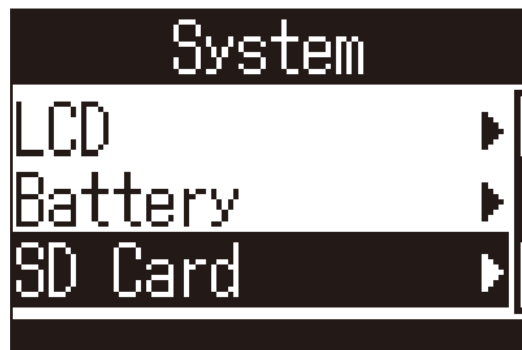

3. Use  and  to select "SD Card", and press .



4. Use  and  to select "Format", and press .



5. Use  and  to select "Execute", and press .

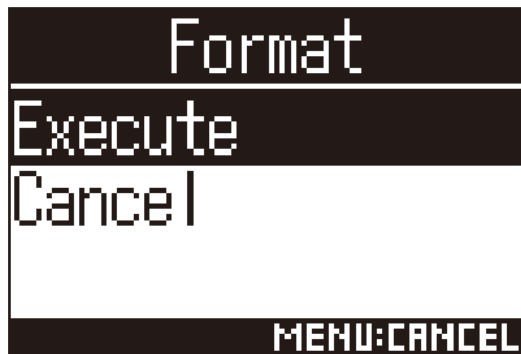

This formats the microSD card for use with the **H3-VR**.

NOTE

- After purchasing a new microSD card, always format it using the **H3-VR** to maximize performance.
- Be aware that all data previously saved on a microSD card will be deleted when it is formatted.

Testing microSD card performance

You can test whether a microSD card can be used with the **H3-VR**.

NOTE

- Even if a performance test result is "Pass", there is no guarantee that writing errors will not occur.

Conducting a quick test

You can quickly test whether a microSD card can be used with the **H3-VR**.

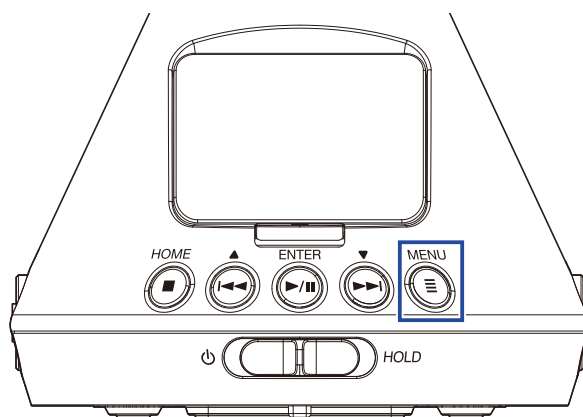

1. Press .



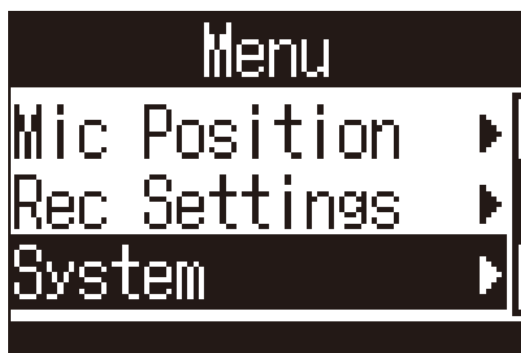

This opens the Menu Screen.

2. Use  and  to select "System", and press .



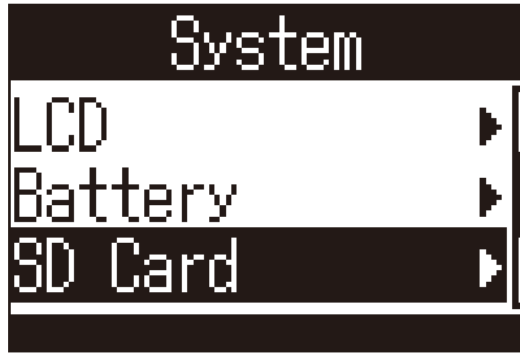

3. Use  and  to select "SD Card", and press .



4. Use  and  to select "Test", and press .



5. Use  and  to select "Quick Test", and press .

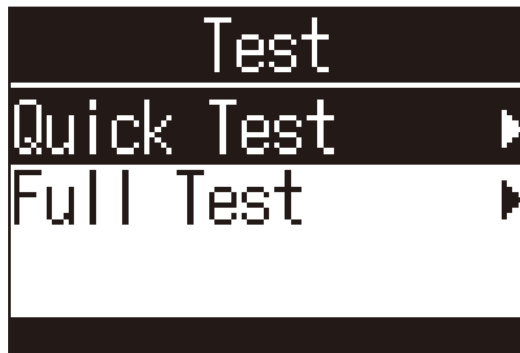

6. Use  and  to select "Execute", and press .

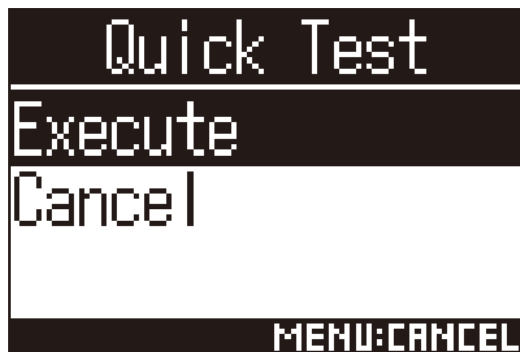

This starts a quick test of the microSD card.

HINT

- The Quick Test should take about 30 seconds.
 - Press  to cancel a quick test.
-

7. Check the result when the test completes.

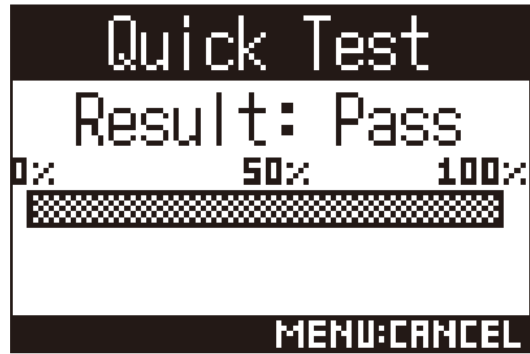

Conducting a full test

You can test whether a microSD card can be used with the **H3-VR** by examining the entire card.

NOTE

- Use the AC adapter to supply power when conducting a full test (→ [“Using an AC adapter” on page 19](#)).

1. Press .

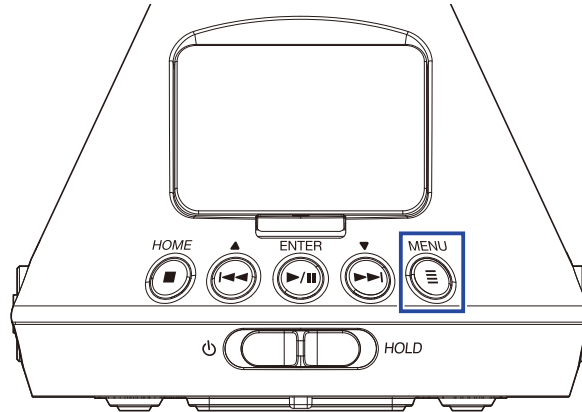

This opens the Menu Screen.

2. Use  and  to select "System", and press .

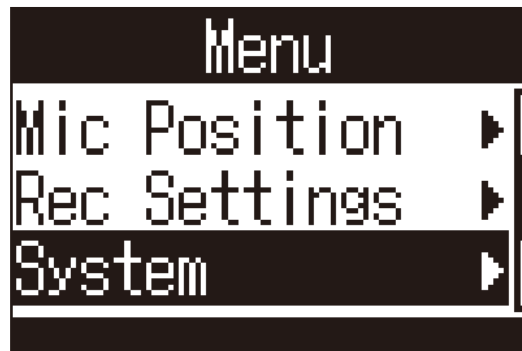

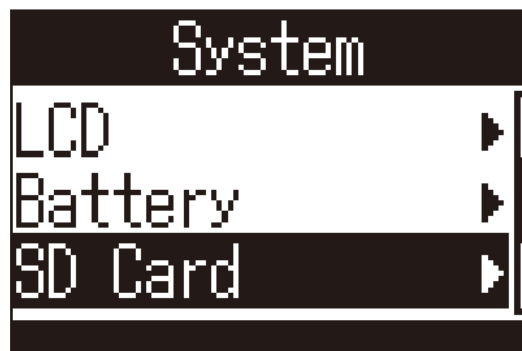

3. Use  and  to select "SD Card", and press .



4. Use  and  to select "Test", and press .



5. Use  and  to select "Full Test", and press .

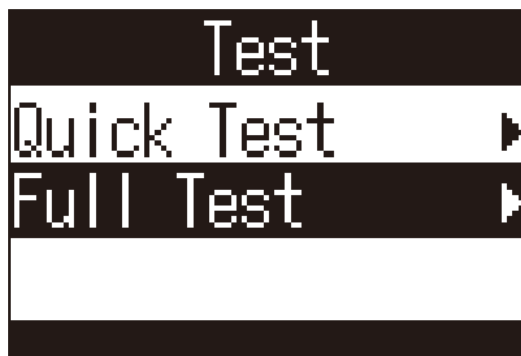

After the amount of time required for the full test is shown briefly, the execution screen will open.

6. Use  and  to select "Execute", and press .

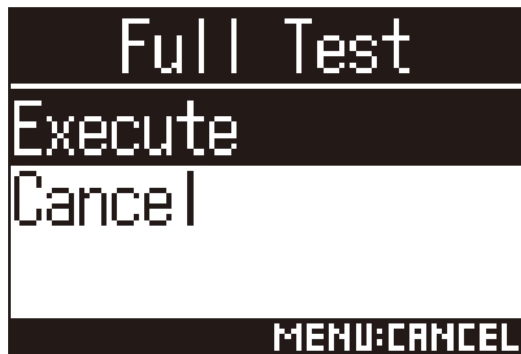

This starts a full test of the microSD card.

HINT

- You can press  to pause and resume the full test.
-

7. Check the result when the test completes.

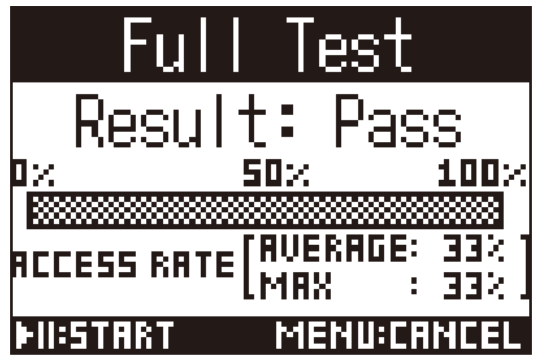

Restoring default settings (Factory Reset)

1. Press .

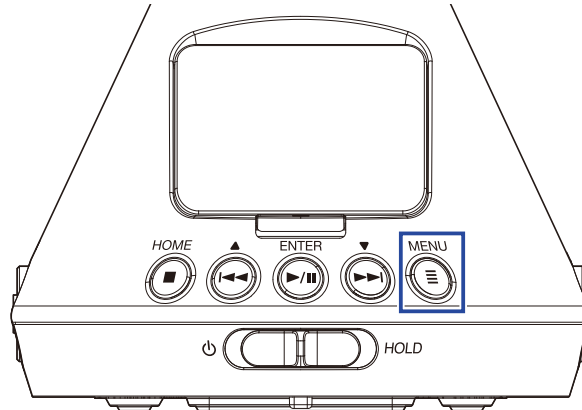



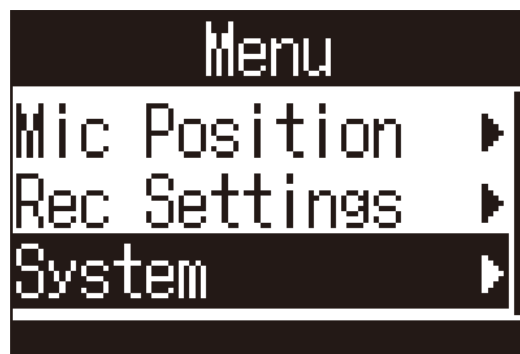

This opens the Menu Screen.

2. Use  and  to select "System", and press .

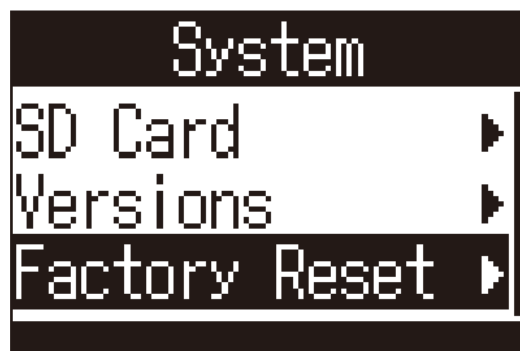

3. Use  and  to select "Factory Reset", and press .



4. Use  and  to select "Execute", and press .

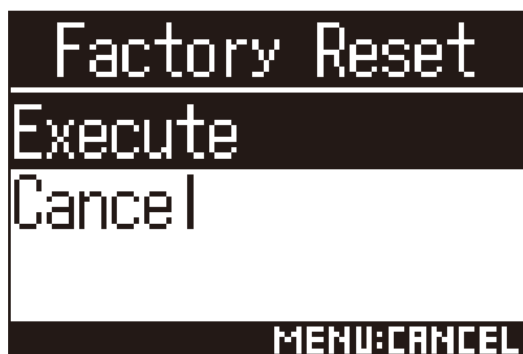

This starts resetting the **H3-VR**.

After the settings are reset, the power will automatically turn off.

Checking the firmware versions

1. Press .

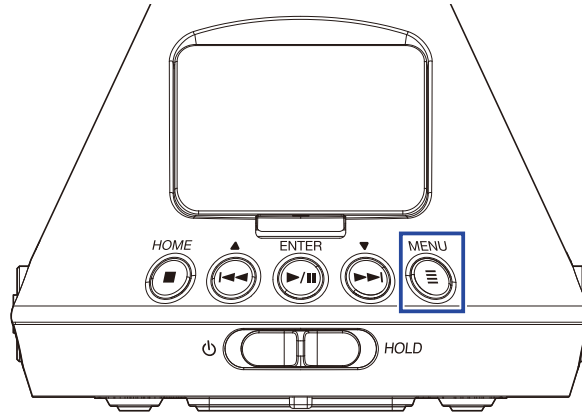

This opens the Menu Screen.

2. Use  and  to select "System", and press .

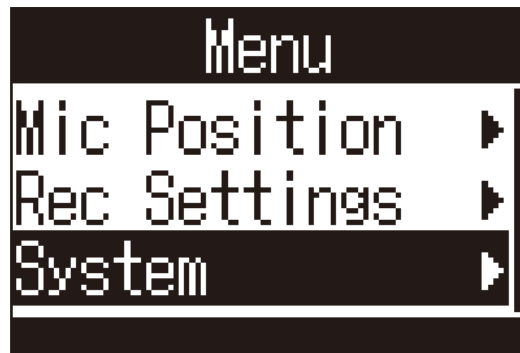

3. Use  and  to select "Versions", and press .

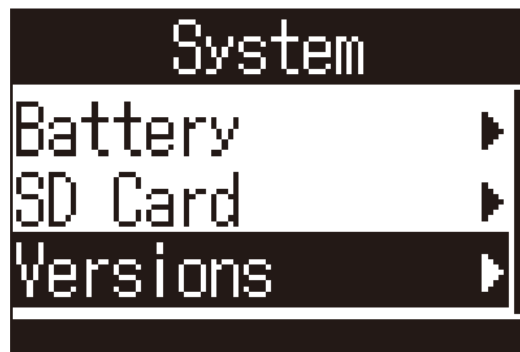

4. Check the firmware versions.

```
Versions
SYSTEM : 1.00
BOOT   : 1.00
MENU:EXIT
```

Updating the firmware

1. Install new batteries in the **H3-VR** or connect an AC adapter.
2. Copy the firmware update file to the root directory on a microSD card.

NOTE

• Files for the latest firmware updates can be downloaded from the ZOOM website (www.zoom.co.jp).

3. Insert the microSD card into the **H3-VR**.

4. While pressing , turn the power on.

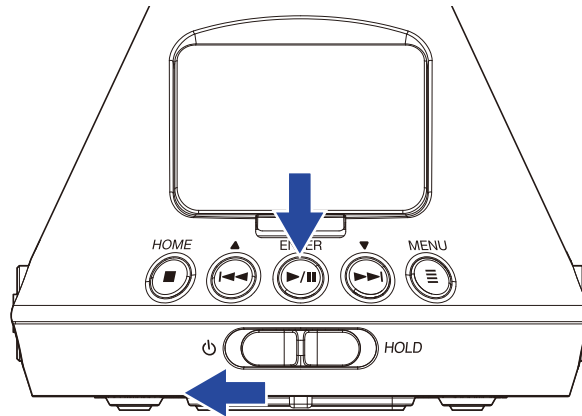

5. Use  and  to select "Update", and press .

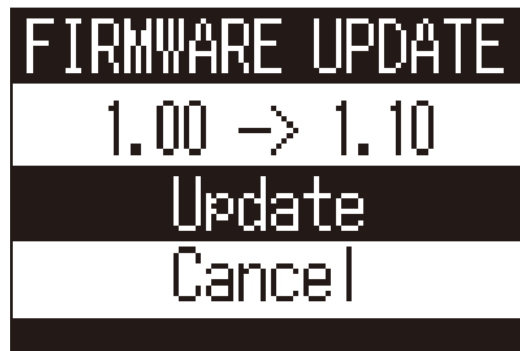

This starts the firmware update.

NOTE

- During the firmware update, do not turn the power off or remove the microSD card. Doing so could cause the **H3-VR** to become unstartable.
- In the unlikely event that a firmware update should fail, conduct the procedures from the beginning to update the firmware again.

6. After the firmware update completes, turn the power off.



Responding to Alert Messages

If one of the messages below appears, follow the instructions to respond to it.

■ Alert messages that appear during startup

Message	Explanation and response
Date/Time Reset	The date and time setting was initialized. Reset the time (→ “Setting the date and time” on page 95).

■ Alert messages that appear when using batteries

Message	Explanation and response
Low Battery!	The remaining battery charge has become low. Replace the batteries with new ones or connect the AC adapter.
No Battery Charge!	When the battery charge becomes low, this appears before the power turns off automatically. Replace the batteries with new ones or connect the AC adapter.

■ Alert messages that appear when the Recording Screen is open

Message	Explanation and response
Cannot Create File!	The maximum number (500) of folders and files that can be created on the same level of the microSD card has been reached. Delete unneeded folders and files or record to a different location.
Card Full!	The microSD has become full. Delete unneeded data or replace it with a new microSD card.
File Number Limit Reached!	The file number limit (999) has been reached.
No SD Card!	No microSD card is loaded. Load a microSD card.
Mark Limit Reached!	The maximum number of marks (99) in one file has been reached.
Invalid SD Card!	The SD card is invalid. Formatting the card with the H3-VR might make it usable.
Now Recording!	The power cannot be turned off during recording. Stop recording before turning the power off.
SD Write Error Mark 	A writing error occurred because the writing speed to the microSD card was insufficient. We recommend using a microSDHC/SDXC card that has been confirmed to operate with this recorder. A list of confirmed microSDHC/SDXC cards can be checked on the ZOOM website (www.zoom.co.jp).

■ Alert messages that appear when the Recording Screen is open

Message	Explanation and response
Invalid File!	The file is not compatible with the H3-VR .
Cannot play 96kHz format	Binaural playback mode cannot be used with files recorded in "96k/16bit" or "96k/24bit" format.
No File!	The selected location does not have any files that can be played. Select a location with files or create a new recording.

■ Alert messages that appear during file operations

Message	Explanation and response
Cannot Create Folder!	The maximum number (500) of folders and files that can be created on the same level of the microSD card has been reached. Delete unneeded folders and files or create a folder in a different location.
Read Only!	The file is protected so it cannot be deleted. Use a computer to check the status of the file.
No File Selected!	Select at least one file.
Folder Name Already Exists!	The folder could not be created because a folder with the same name already exists. Use a different name.
File Name Already Exists!	The file could not be changed because a file with the same name already exists. Use a different name.
Input Folder (File) name!	At least one character must be input when changing folder and file names.
Character Limit Reached!	The maximum number of characters that can be input has been reached.

Troubleshooting

If you think that the **H3-VR** is operating strangely, check the following items first.

Recording/playback trouble

■ No sound is output/volume is low

- Confirm that the volume of the **H3-VR** is not set too low.
- Check the volume of the computer, iOS device or other equipment connected to the **H3-VR**.

■ Recorded audio cannot be heard or is very quiet

- Confirm that the mic is pointed in the right direction.(→ [“Setting the mic position” on page 27](#)).
- Check the input level settings (→ [“Adjusting input levels” on page 37](#)).

■ Unable to record

- Confirm that the REC LED is lit (→ [“Names of parts” on page 13](#)).
- Check the remaining recordable time on the Home Screen (→ [“Home Screen \(in recording standby\)” on page 26](#)).
- Confirm that a microSD card is loaded properly in the card slot (→ [“Inserting microSD cards” on page 20](#)).
- If the HOLD function is on, button operations will be disabled. Disable the HOLD function (→ [“Preventing misoperation \(HOLD function\)” on page 23](#)).

■ Recorded sound does not play back properly

If the orientation of the mic during recording is different from the Mic Position setting, proper playback of the different direction signals will not be possible.

- Use the orientation of the mic during recording that matches the Mic Position setting (→ [“Setting the mic position” on page 27](#)).

Other trouble

■ Computer does not recognize the **H3-VR** when connected by a USB cable

- Confirm that the operating system of the connected computer is supported on the ZOOM website (www.zoom.co.jp).
- The USB function must be set on the **H3-VR** to allow the computer to recognize it (→ [“Using as a card reader” on page 77](#), [“Using as an audio interface” on page 80](#)).

■ Battery operation time is short

Making the following settings could increase the battery operation time.

- Set the battery type setting to match the batteries being used (→ [“Setting the type of batteries used” on page 88](#)).
- Turn off the display backlight (→ [“Setting the display backlight” on page 90](#)).
- Reduce the sampling rate used to record files (→ [“Setting the recording format” on page 32](#)).

Metadata list

■ Metadata contained in WAV file BEXT chunks

Tag	Remarks
zTAKE=	File number
zSCENE=	Scene name Use the following Menu item to set this. Menu > Rec Settings > Rec File Name
zTRK1=	Track names
zTRK2=	FuMa: zTRK1=W, zTRK2=X, zTRK3=Y, zTRK4=Z AmbiX: zTRK1=W, zTRK2=Y, zTRK3=Z, zTRK4=X
zTRK3=	Ambisonics A: zTRK1=FLU, zTRK2=FRD, zTRK3=BLD, zTRK4=BRU Stereo: zTRK1=L, zTRK2=R
zTRK4=	Binaural: zTRK1=L, zTRK2=R
zNOTE=	This can be set and edited from an iOS device. Menu > Rec Settings > Rec File Note Menu > Finder > Options > Note

■ Metadata contained in WAV file iXML chunks

iXML tag	Remarks
<SCENE>	Menu > Rec Settings > Rec File Name > Auto (Date) Menu > Rec Settings > Rec File Name > User Defined Name Menu > Finder > Options > Rename
<TAKE>	Menu > Finder > Options > Rename
<FILE_UID>	
<NOTE>	This can be set and edited from an iOS device. Menu > Rec Settings > Rec File Note Menu > Finder > Options > Note
<SPEED><FILE_SAMPLE_RATE>	Menu > Rec Settings > Rec Format
<SPEED><AUDIO_BIT_DEPTH>	Menu > Rec Settings > Rec Format
<SPEED><DIGITIZER_SAMPLE_RATE>	Menu > Rec Settings > Rec Format
<SPEED><TIMESTAMP_SAMPLES_SINCE_MID-NIGHT_HI>	
<SPEED><TIMESTAMP_SAMPLES_SINCE_MID-NIGHT_LO>	
<SPEED><TIMESTAMP_SAMPLE_RATE>	Menu > Rec Settings > Rec Format
<HISTORY><ORIGINAL_FILENAME>	
<FILE_SET><TOTAL_FILES>	
<FILE_SET><FAMILY_UID>	
<FILE_SET><FILE_SET_INDEX>	
<TRACK_LIST><TRACK_COUNT>	
<TRACK_LIST><TRACK><CHANNEL_INDEX>	
<TRACK_LIST><TRACK><INTERLEAVE_INDEX>	
<TRACK_LIST><TRACK><NAME>	

Specifications

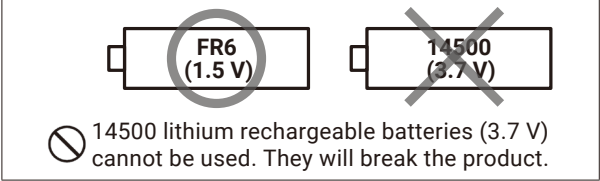
Recording media	Cards compatible with microSD/microSDHC/microSDXC specifications (Class 4 or higher)
Recording formats	<p>Ambisonics A, Ambisonics B (FuMa/AmbiX) WAV 4ch poly (supports BWF and iXML): 44.1 kHz/16-bit, 44.1 kHz/24-bit, 48 kHz/16-bit, 48 kHz/24-bit, 96 kHz/16-bit, 96 kHz/24-bit</p> <p>Stereo WAV stereo (supports BWF and iXML): 44.1 kHz/16-bit, 44.1 kHz/24-bit, 48 kHz/16-bit, 48 kHz/24-bit, 96 kHz/16-bit, 96 kHz/24-bit</p> <p>Binaural WAV stereo (supports BWF and iXML): 44.1 kHz/16-bit, 44.1 kHz/24-bit, 48 kHz/16-bit, 48 kHz/24-bit</p>
Display	1.25" monochrome LCD (96×64)
Motion sensor	6 axes (3-axis gyro, 3-axis acceleration)
Built-in Ambisonic mic	4 matched unidirectional condenser mics Maximum sound pressure input: 120 dB SPL Mic gain: +18 – +48 dB
LINE OUT	Connector: 3.5 mm stereo mini Maximum output level: -10 dBu (1 kHz, 10 kΩ load)
PHONE OUT	Connector: 3.5 mm stereo mini Maximum output level: 20 mW + 20 mW (into 32Ω load)
USB	Connector: microUSB <u>Mass storage operation</u> USB 2.0 High Speed <u>Audio interface operation</u> 2 in/2 out (stereo/binaural input) USB 2.0 Full Speed, 44.1 kHz/16-bit, 48 kHz/16-bit 4 in/2 out (Ambisonics A/FuMa/ AmbiX input) USB 2.0 High Speed, 44.1 kHz/24-bit, 48 kHz/24-bit
Power	2 AA batteries (alkaline, lithium, or rechargeable NiMH) AC adapter (ZOOM AD-17): DC 5V/1A (supports USB bus power)
Estimated continuous recording time using batteries	48 kHz/24-bit, FuMa Rec Mode Alkaline batteries: about 11.5 hours NiMH batteries (1900 mAh): about 11.5 hours Lithium batteries: about 24 hours
	 <p>14500 lithium rechargeable batteries (3.7 V) cannot be used. They will break the product.</p>
	<ul style="list-style-type: none"> • The above values are approximate. • Continuous battery operation times were determined using in-house testing methods. They will vary greatly according to use conditions.
External dimensions	76 mm (W) × 78 mm (D) × 123 mm (H)
Weight (main unit only)	120 g



4-4-3 Kanda-surugadai, Chiyoda-ku, Tokyo 101-0062 Japan
www.zoom.co.jp