

GM-200

Guitar Amp Modeler

VAMS

OPERATION MANUAL

Introduction

Thank you for selecting the **ZOOM GM-200** (hereafter simply called the "**GM-200**"). The GM-200 is a modeling type guitar amp simulator with the following features and functions.

- **Wide range of guitar amp sounds**

Using the Variable Architecture Modeling System (VAMS) developed by Zoom, the GM-200 models the sound characteristics of various famous guitar amplifiers. Simply by operating the AMP SELECT knob, you can produce a wide range of sound characteristics, from vintage fifties amps to the latest in modern technology.

- **Compatible with virtually any playback system**

Output characteristics and signal processing can be adapted to the requirements of various systems with the OUTPUT CHARACTER knob. The GM-200 is a versatile playing tool, whether you use it for stage rehearsals, practicing with a radio/ cassette/ CD player, or a direct line out to a multi-track recorder (MTR).

- **4 types of effects for guitar play**

The GM-200 also incorporates four types of vintage effects that are essential for great guitar sound, including vintage chorus, tremolo, tape echo, and spring reverb. A single knob on the panel lets you select effects and adjust their intensity.

- **Versatile input/output configuration**

In addition to the phone jack for guitar input, the unit also provides a MIX IN jack (stereo mini phone plug) which is handy for connecting a CD player, MD player or other source for mixing with the guitar sound. On the output side, there is a stereo phone jack as well as RCA type phono jacks, allowing easy connection to any kind of equipment, such as guitar amps, an audio system, a portable stereo, etc. Stereo headphones can also be plugged in, for those late-night practice sessions.

- **Dual power supply**

The dual power supply principle allows the unit to be powered from the AC adapter or six IEC R6 (size AA) batteries. This lets you easily take the GM-200 on stage or into a rehearsal studio, in the same way as a compact guitar effect.

Please take the time to read this manual carefully so as to get the most out of your GM-200 and to ensure optimum performance and reliability. Retain this manual, the warranty card and all other documentation for future reference.

Contents

Safety Precautions/Usage Precautions	2
Controls and Features	3
Top Panel	3
Rear Panel	3
Getting Connected	4
Battery Operation	5
Power-On	5
Trying Out the GM-200	6
Output Character Settings	8
Selecting the Amp Type	9
Sample Settings	10
Troubleshooting / Specifications	

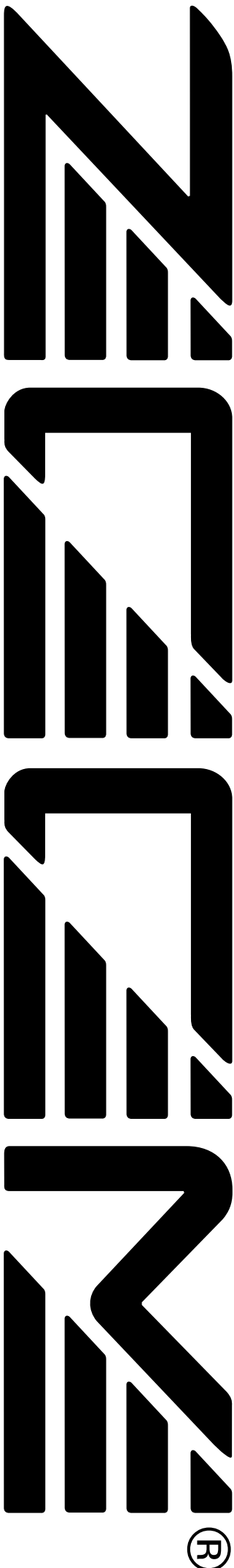

Safety Precautions/Usage Precautions

Safety Precautions

In this manual, symbols are used to highlight warnings and cautions for you to read so that accidents can be prevented. The meanings of these symbols are as follows:



This symbol indicates explanations about extremely dangerous matters. If users ignore this symbol and handle the device the wrong way, serious injury or death could result.



This symbol indicates explanations about dangerous matters. If users ignore this symbol and handle the device the wrong way, bodily injury and damage to the equipment could result.

Please observe the following safety tips and precautions to ensure hazard-free use of the GM-200.



• Power requirements

Since power consumption of this unit is fairly high, we recommend the use of an AC adapter whenever possible. When powering the unit from a battery, use only an alkaline type.

[AC adapter operation]

- Be sure to use only an AC adapter which supplies 9 V DC, 300 mA and is equipped with a "center minus" plug (Zoom AD-0006). The use of an adapter other than the specified type may damage the unit and pose a safety hazard.
- Connect the AC adapter only to an AC outlet that supplies the rated voltage required by the adapter.
- When disconnecting the AC adapter from the AC outlet, always grasp the adapter itself and do not pull at the cable.
- When not using the unit for an extended period, disconnect the AC adapter from the AC outlet.

[Battery Powered Operation]

- Use six IEC R6 (size AA) 1.5V batteries (alkaline).
- The GM-200 cannot be used for recharging. Pay close attention to the labelling of the battery to make sure you choose the correct type.
- When not using the unit for an extended period, remove the batteries from the unit.
- If battery leakage has occurred, wipe the battery compartment and the battery terminals carefully to remove all remnants of battery fluid.
- While using the unit, the battery compartment cover should be closed.



• Environment

Avoid using your GM-200 in environments where it will be exposed to:

- Extreme temperature
- High humidity or moisture
- Excessive dust or sand
- Excessive vibration or shock



• Handling

Since the GM-200 is a precision electronic device, avoid applying excessive force to the switches and buttons. Also take care not to drop the unit, and do not subject it to shock or excessive pressure.



• Alterations

Never open the case of the GM-200 or attempt to modify the product in any way since this can result in damage to the unit.



• Connecting cables and input and output jacks

You should always turn off the power to the GM-200 and all other equipment before connecting or disconnecting any cables. Also make sure to disconnect all cables and the AC adapter before moving the GM-200.

Usage Precautions

• Electrical interference

For safety considerations, the GM-200 has been designed to provide maximum protection against the emission of electromagnetic radiation from inside the device, and protection from external interference. However, equipment that is very susceptible to interference or that emits powerful electromagnetic waves should not be placed near the GM-200, as the possibility of interference cannot be ruled out entirely.

With any type of digital control device, the GM-200 included, electromagnetic interference can cause malfunctioning and can corrupt or destroy data. Care should be taken to minimize the risk of damage.

• Cleaning

Use a soft, dry cloth to clean the GM-200. If necessary, slightly moisten the cloth. Do not use abrasive cleanser, wax, or solvents (such as paint thinner or cleaning alcohol), since these may dull the finish or damage the surface.

Please keep this manual in a convenient place for future reference.

Controls and Functions

Top Panel

- ① **POWER indicator**
This LED lights up while the GM-200 is powered. When operating the unit on battery power, the indicator starts to flash when the batteries are running low.
- ② **AMP SELECT knob**
Gives a choice of 11 different guitar amp characteristics.
- ③ **EFFECTS knob**
Allows you to choose between four effects and adjust their intensity.
- ④ **OUTPUT CHARACTER knob**
Allows matching the output signal of the GM-200 to the requirements of the playback system. Signal characteristics and processing are changed internally.

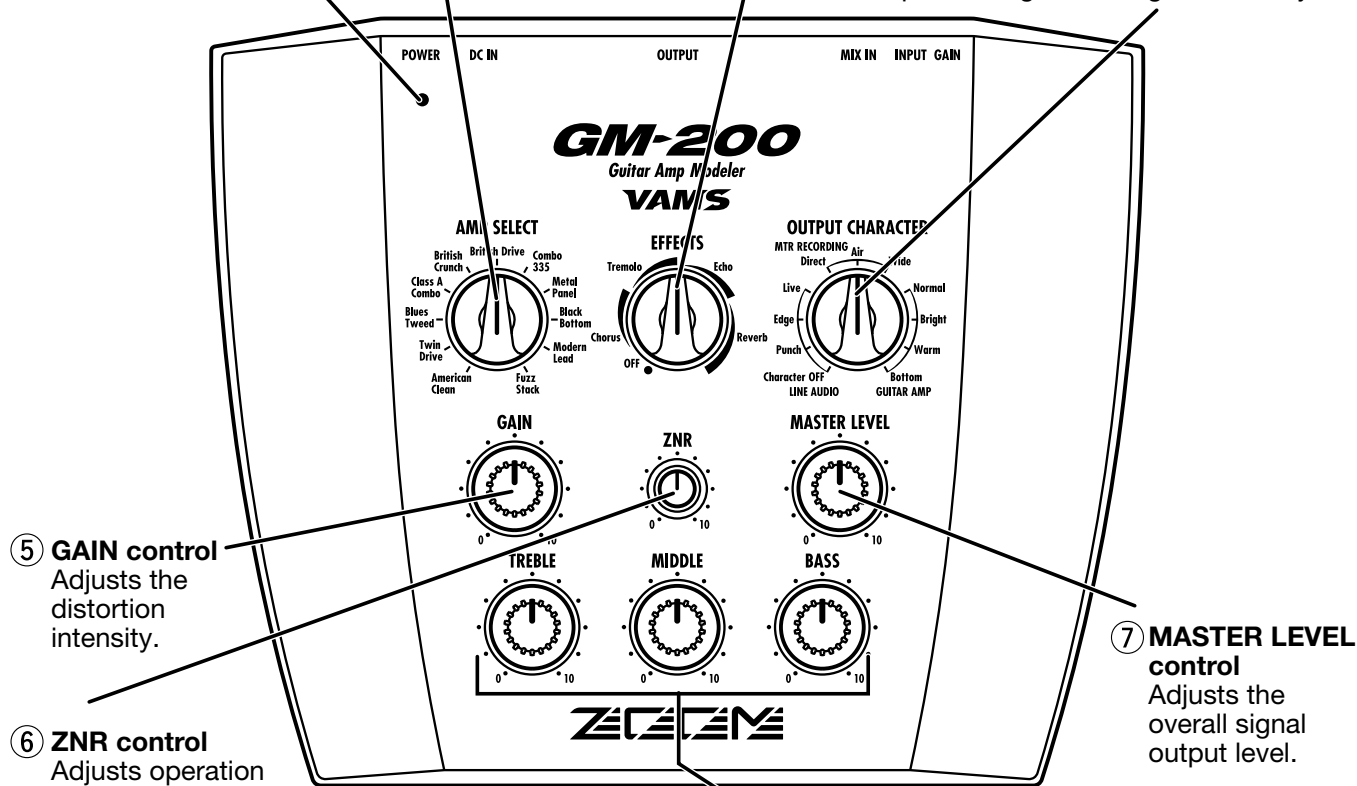

- ⑤ **GAIN control**
Adjusts the distortion intensity.
- ⑥ **ZNR control**
Adjusts operation of the ZNR (Zoom Noise Reduction) circuit.
- ⑦ **MASTER LEVEL control**
Adjusts the overall signal output level.
- ⑧ **TREBLE/MIDDLE/BASS controls**
The three-band tone control for treble, midrange, and bass allows tailoring the sound as in a guitar amplifier.

Rear Panel

- ⑨ **INPUT GAIN switch**
Adjusts the gain for the signal input via the INPUT jack (⑩).
 For connection of guitars with low output (passive type)
 For connection of guitars with high output (active type)
- NOTE** Turn off power to the amplifier before changing the setting of the INPUT GAIN switch. If the switch is operated while the amplifier is on, shock noise may damage the speakers.
- ⑩ **INPUT jack**
Connect the guitar to this jack.
- ⑪ **MIX IN jack**
This stereo mini jack accepts the signal from an external source. The signal supplied to this jack is not processed by the effect circuitry of the GM-200. It is simply mixed to the guitar signal and sent to the output.
- ⑫ **OUTPUT L/R jacks**
This stereo pair of RCA type phono jacks serves for connection to a Hi-Fi system, portable stereo, multi-track recorder or other component equipped with a line input.
- ⑬ **OUTPUT jack**
This stereo phone jack serves for connection to a guitar amp. It is also possible to plug a pair of stereo headphones into this jack, or to use a Y cable for sending the output to two amplifiers.
- ⑭ **DC IN (AC adapter) jack**
To use the GM-200 on AC power, plug the supplied AC adapter into this jack.
- ⑮ **POWER switch**
Serves to turn the unit on and off.

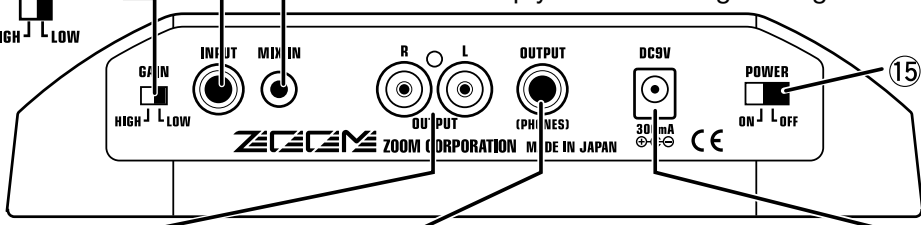

Controls and Features

Getting Connected

Audio System Connection (for line audio)

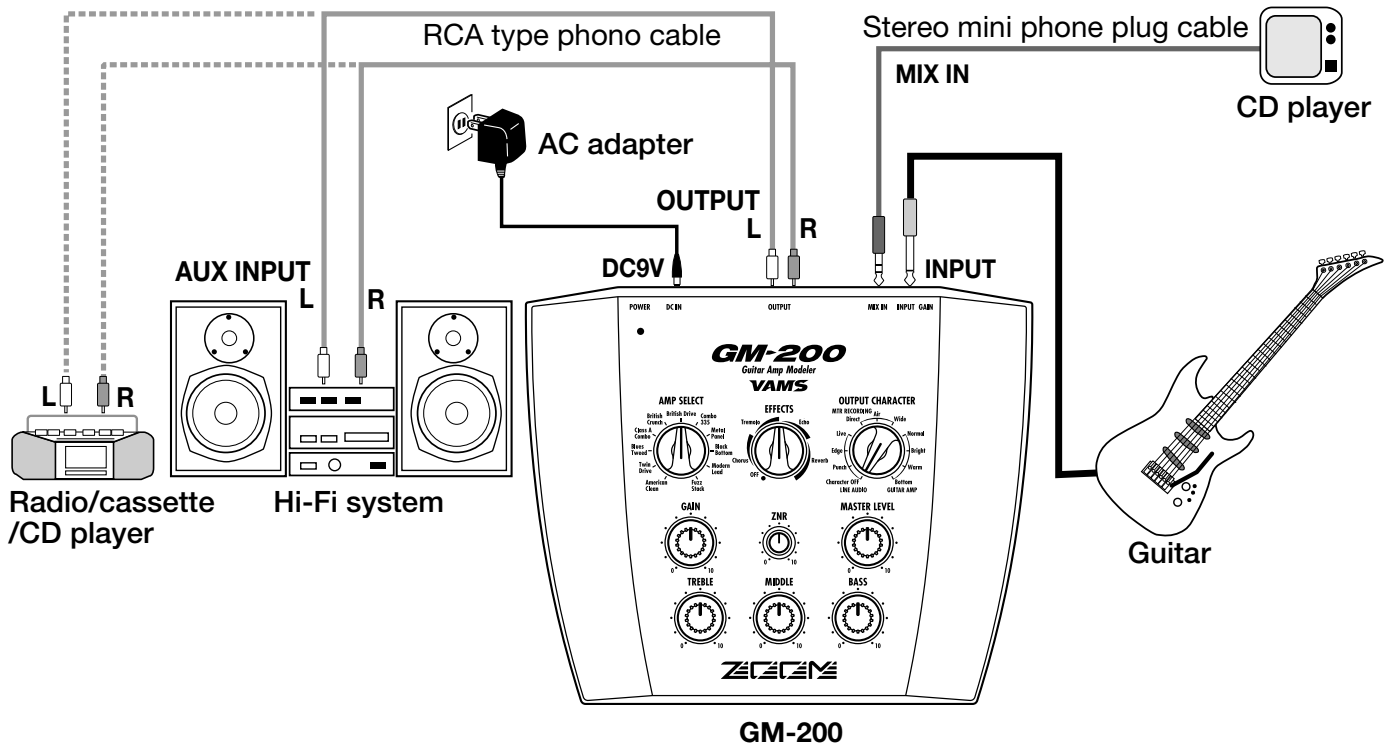

This example shows how to connect the GM-200 to a Hi-Fi system or a portable stereo such as a radio/ cassette/ CD player or similar. Use two audio cables with RCA type plugs to connect the OUTPUT L/R jacks of the GM-200 to the AUX inputs (line inputs) of the stereo system. By connecting the line output of a CD player or MD player to the MIX IN jack of the GM-200 using a stereo mini phone plug cable, you can mix the sound from a CD or MD to your session.

MTR/Recording Mixer Connection (for recording)

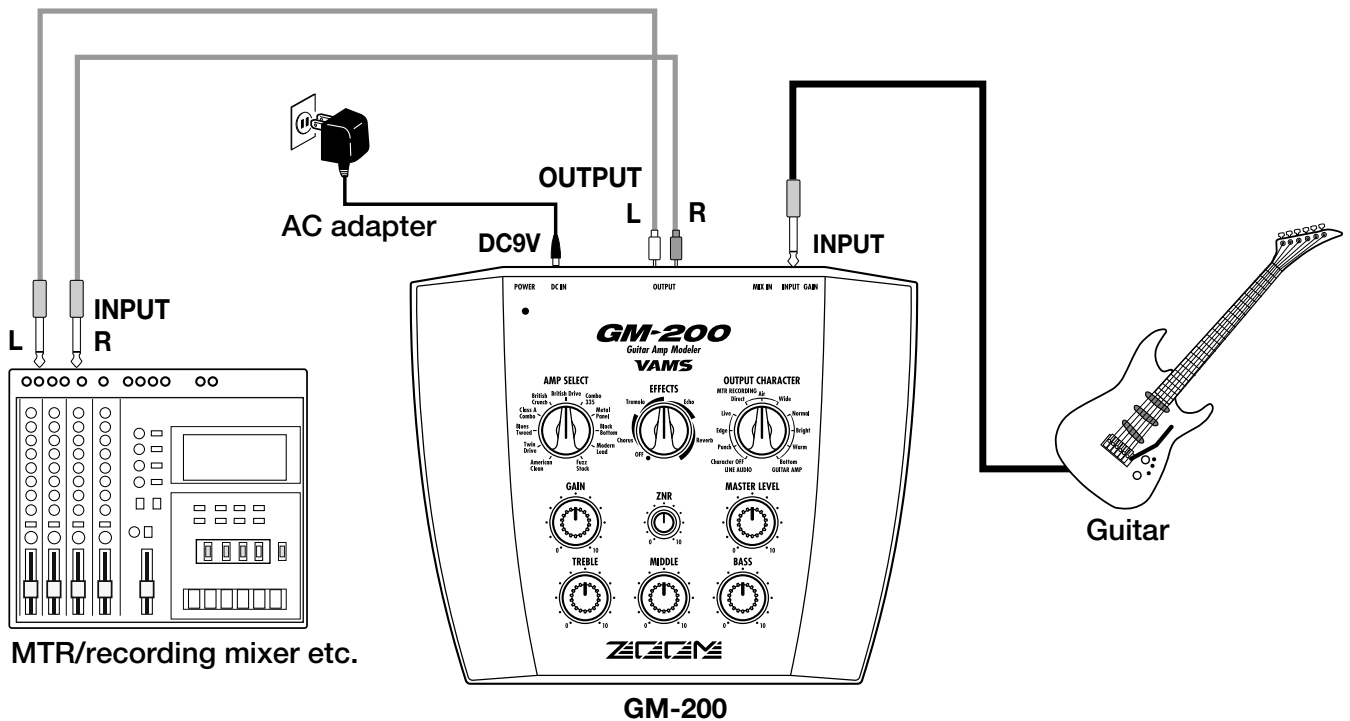

This example shows how to connect the GM-200 to a multi-track recorder or a recording mixer or similar. Use a shielded mono cable with phone plug or two cables with RCA type phono plugs to connect the OUTPUT jack (or OUTPUT L/R jacks) of the GM-200 to the line inputs of the recorder.

Guitar Amplifier Connection (for guitar amplifier)

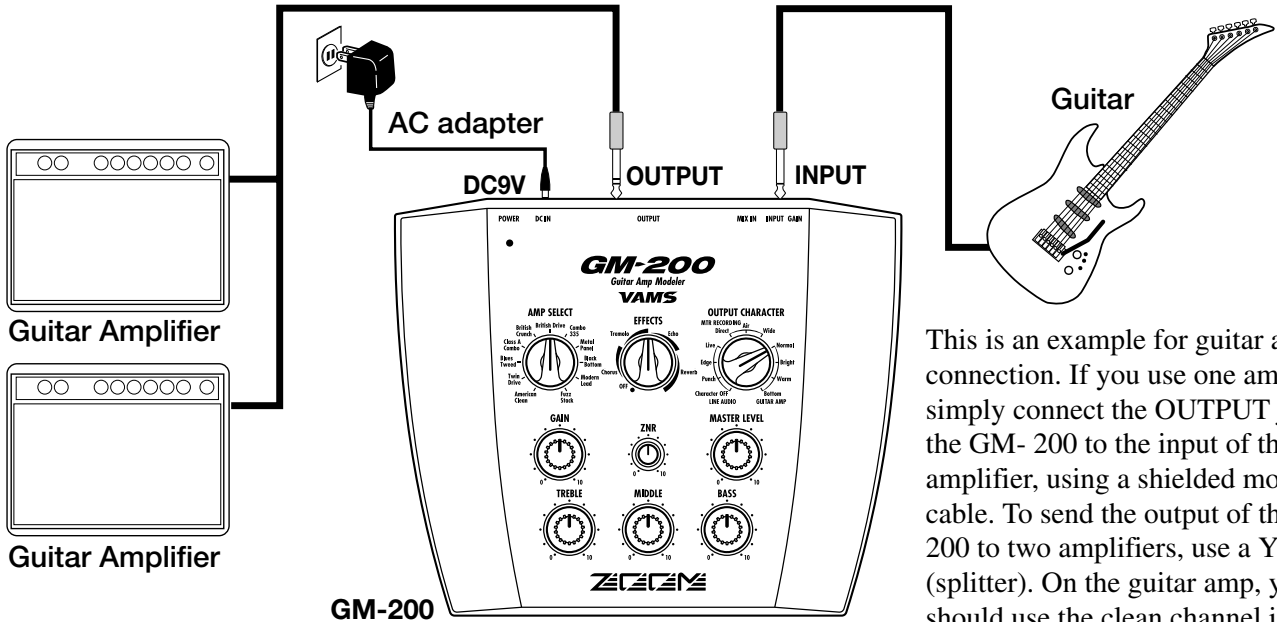

This is an example for guitar amp connection. If you use one amplifier, simply connect the OUTPUT jack of the GM-200 to the input of the amplifier, using a shielded mono cable. To send the output of the GM-200 to two amplifiers, use a Y cable (splitter). On the guitar amp, you should use the clean channel input with no equalization.

Battery Operation / Power-On

Battery Operation

The GM-200 can be powered either from the supplied AC adapter or from six IEC R6 (size AA) batteries. When the GM-200 is operating on battery power, the POWER indicator starts to flash when the batteries are running low. In such a case, replace the batteries as soon as possible.

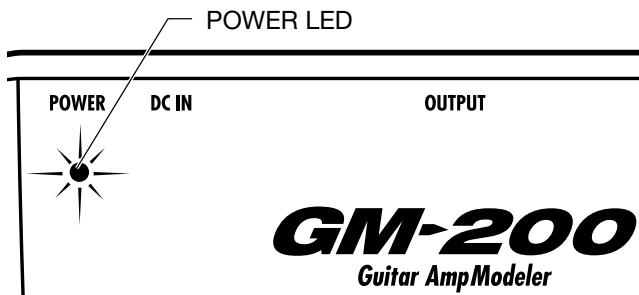

Rear of GM-200

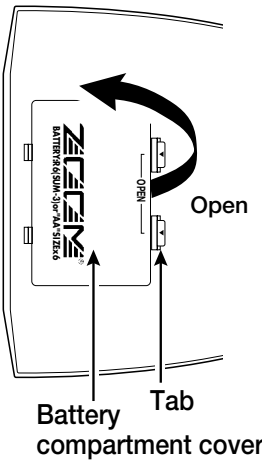

Six IEC R6 (size AA) batteries

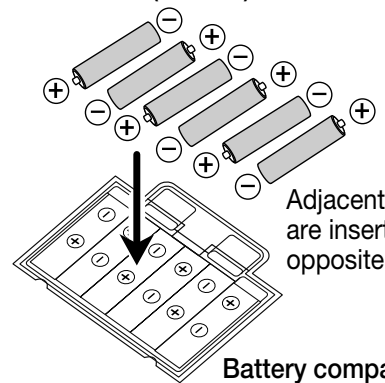

Adjacent batteries are inserted with opposite polarity.

Power-On

1. Verify that the AC adapter, guitar, and playback system are correctly connected to the GM-200.

NOTE Turn off power to the amplifier before changing the setting of the INPUT GAIN switch. If the switch is operated while the amplifier is on, shock noise may damage the speakers.

2. Turn the ZNR control and MASTER LEVEL control of the GM-200 as well as the volume control of the playback system to minimum.

3. Turn on the equipment in the order GM-200 → playback system.
4. Raise the MASTER LEVEL control of the GM-200 to a position that will provide a suitable volume.

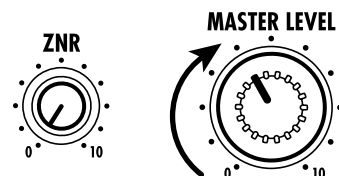

Trying Out the GM-200

To use the GM-200 for creating various types of sound, perform the following steps.

1. Select the output character

Use the OUTPUT CHARACTER knob to choose among the various options, as described on page 8. Make the setting to match the type of system to which the GM-200 is connected.

2. Select the amp type

Use the AMP SELECT knob to choose the guitar amplifier type that is simulated by the unit, as listed on page 9.

3. Adjust distortion intensity and volume

Use the GAIN control to adjust the distortion intensity. Because turning up this control not only increases distortion but also raises the volume level, use the MASTER LEVEL control as necessary to adjust the level.

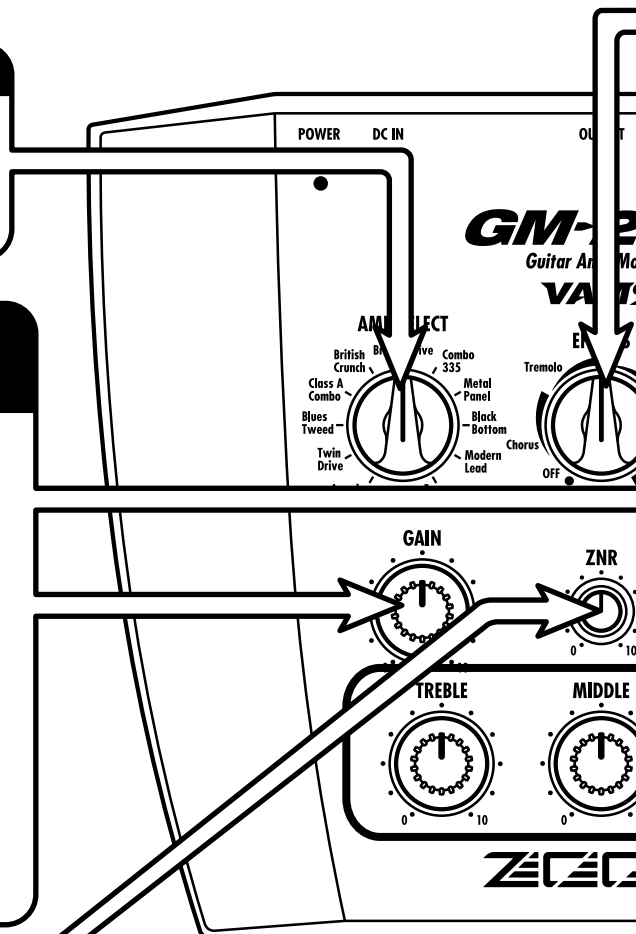
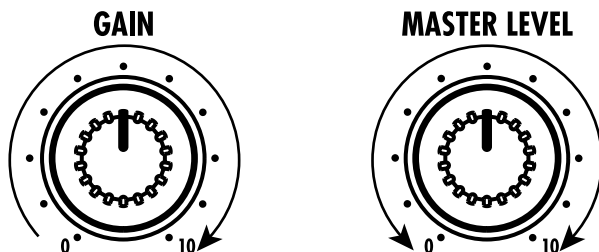

Trying Out the GM-200

4. Adjust ZNR (Zoom Noise Reduction)

Use the ZNR control to set the threshold for the ZNR circuit that reduces noise during play pauses. When the control is turned fully to the left, ZNR is off. Turning the control to the right gradually raises the action threshold. Set the control to achieve maximum noise reduction without causing the sound to be cut off unnaturally.



The optimum ZNR point will differ for various amp types and gain settings. Readjust the ZNR control if you have changed the setting of the AMP SELECT knob or the GAIN control.



5. Adjust effect type and intensity

Use the EFFECTS control to select one of the following four effects and adjust its intensity.

TREMOLO

The sound fluctuates periodically. The more the knob is turned to the right within the TREMOLO range, the faster the tremolo speed.

ECHO

This is a soft delay effect which resembles a tape echo. The more the knob is turned to the right within the ECHO range, the longer the delay time interval.

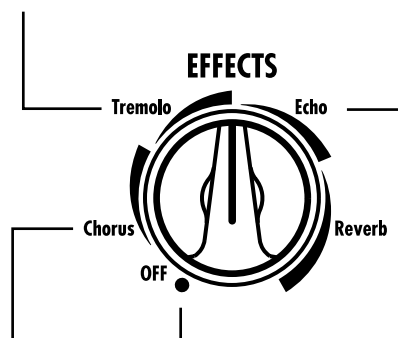

REVERB

This is a reverb effect which resembles a spring reverb. The more the knob is turned to the right within the REVERB range, the higher the effect mix level. The reverb duration and spread changes according to the setting of the AMP SELECT knob.

CHORUS

This is a stereo chorus effect which lends body to the sound. The more the knob is turned to the right within the CHORUS range, the faster the chorus modulation speed and the higher the effect mix level.

OFF

No effect processing is carried out.

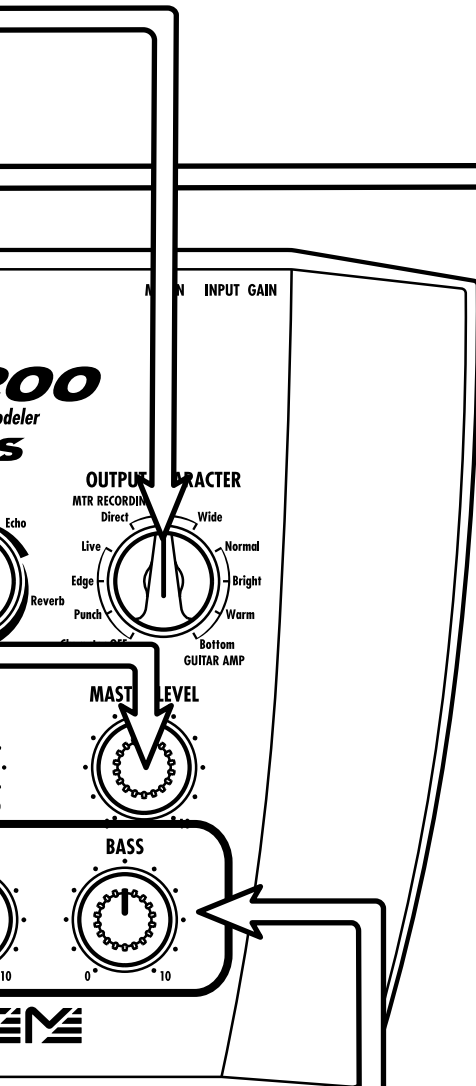

Trying Out the GM-200

6. Adjust tone

Use the TREBLE/MIDDLE/BASS controls to adjust the respective frequency range as desired.

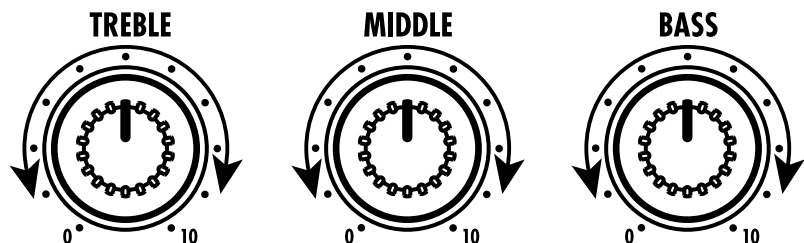

Output Character Settings

Use the OUTPUT CHARACTER knob to choose among the following options. Make the setting to match the connection type (see pages 4 - 5) and your personal preferences.

LINE AUDIO

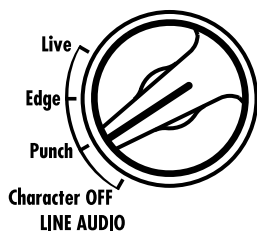

These settings are optimized for use of the unit together with a playback system such as a Hi-Fi system or portable stereo. Normally, when connecting the output of a conventional preamplifier or compact effect to an audio system, the sound will often be too thin and flat. The LINE AUDIO settings provide lively, tight guitar sound in such circumstances.

Character OFF : Standard line amp character

Punch : Sound with a strong midrange punch

Edge : Results in attacks with a hard edge

Live : Fresh, lively sound

MTR RECORDING

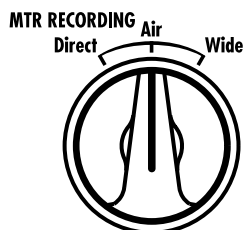

These settings are optimized for line recording using a multi-track recorder or recording mixer or similar. With these settings, it is easy to create a professional guitar sound during recording and to match the GM-200 output to the sound of other instruments being recorded.

Direct : Emulates the sound of a guitar amp picked up with a close-up microphone

Air : Emulates the acoustics of a room, with a feeling of depth and spaciousness

Wide : Emulates a wide spread created with two microphones used in a stereo arrangement



Special effect using phase shift. Depending on the selected tone and on the played pitch, the sound localization changes.

GUITAR AMP

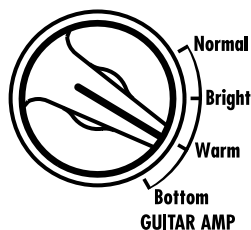

These settings are optimized for use with a guitar amplifier.

Normal : Basic sound as obtained when connected to a guitar amplifier

Bright : Brilliant sound with strong treble

Warm : Warm sound with midrange emphasis

Bottom : Metallic sound with treble and bass emphasis

Selecting the Amp Type

Use the AMP SELECT knob to choose among the following options.

American Clean	Emulates a tube type combo amp developed in the sixties by an American company known for its single-coil pickup guitars. This famous amplifier had a clean, bright sound and beautiful sounding spring reverb. The setting emulates the typical clean channel sound of this amplifier. Depending on the guitar in use, the sound may be distorted at certain settings of the GAIN control.
Twin Drive	Emulates the drive channel sound of the above type of amp. Although this is a drive channel, distortion is smooth and subdued, and the top end is bright and extended.
Blues Tweed	Emulates a small tube type combo amp built in the nineteen-fifties by the same company as the amp described above. Originally developed as a practice amplifier for beginners, many rock and blues artists in the sixties used it for recording because of its superb distortion sound at low levels. This setting works best at fairly low settings of the GAIN control, using the picking intensity to vary the distortion amount.
Class A Combo	Emulates the British-built tube amp that became the hallmark of the Liverpool sound in the sixties. Famous for some unique circuit design aspects, such as the tube-based rectifier and class A amplifier topology. The clean sound and crunch sound are typical, but raising the GAIN control will result in harder distortion.
British Crunch	Emulates the crunch sound of a tube stack amp from a British manufacturer who ruled the eighties scene. This setting is based on the 800 line of amplifiers with master volume control. A slight crunch sound is obtained even with the GAIN control turned down.
British Drive	Emulates the full drive sound of the 900 line that succeeded the above type of amp. By adjusting the GAIN control and MASTER LEVEL control, you can vary the sound from crunch to deep distortion. Very well suited for hard rock or heavy metal lead guitar.
Combo 335	In the late sixties, a manufacturer in San Francisco led the move towards high output power, with a hand-built tube combo amp. The setting emulates the sound of this amplifier, which was famous for its detailed overdrive and long sustain. Great for fusion style lead guitar.
Metal Panel	Emulates the sound of a tube type stack amp with intense distortion, designed by the same manufacturer for the metal bands of the nineties. These amplifiers allowed switching between diode and tube based rectifiers, resulting in a drastically different sound character. Suited especially for marking the rhythm with distortion sound.
Black Bottom	Emulates a famous tube stack amp developed by an American amp manufacturer in the nineteen-eighties in cooperation with a hard rock superstar. The original amplifier which even was used as the title of an album has a gutsy low end and high-gain, detailed distortion.
Modern Lead	Emulates a head amplifier made in America by a custom manufacturer in the eighties, but used extensively in the nineties on the road and in the studio by a guitarist famous for his "woman tone". Great for lead guitar playing.
Fuzz Stack	Creates a dynamic sixties style stack amp sound with fuzz distortion. Suitable for single-note leads and riffs.

Sample Settings (LINE AUDIO)

The examples shown below are for use of the GM-200 with an audio system or portable stereo.

- Set the **ZNR** and **MASTER LEVEL** controls as required.
- When wishing to use the settings with a guitar amp, try setting the **OUTPUT CHARACTER** knob to "GUITAR AMP".

Surf sound of built-in type tube amp. Changing the effect to tremolo also works well.	AMP SELECT	EFFECTS	OUTPUT CHARACTER	GAIN	TREBLE	MIDDLE	BASS
	American Clean	Reverb	Live				
Drive sound of built-in type tube amp, great for southern rock.	AMP SELECT	EFFECTS	OUTPUT CHARACTER	GAIN	TREBLE	MIDDLE	BASS
	Twin Drive	Echo	Live				
Here comes Mr. Bassman, with the blues guitar sound of the good old days.	AMP SELECT	EFFECTS	OUTPUT CHARACTER	GAIN	TREBLE	MIDDLE	BASS
	Blues Tweed	OFF	Punch				
Combo amp crunch sound essential for true Liverpool sound.	AMP SELECT	EFFECTS	OUTPUT CHARACTER	GAIN	TREBLE	MIDDLE	BASS
	Class A Combo	OFF	Live				
Crunch sound of British style tube stack amp with great definition.	AMP SELECT	EFFECTS	OUTPUT CHARACTER	GAIN	TREBLE	MIDDLE	BASS
	British Crunch	OFF	Character OFF				
Drive sound of British high-gain stack amp.	AMP SELECT	EFFECTS	OUTPUT CHARACTER	GAIN	TREBLE	MIDDLE	BASS
	British Drive	OFF	Live				
High-class combo amp, great for plucky lead solos.	AMP SELECT	EFFECTS	OUTPUT CHARACTER	GAIN	TREBLE	MIDDLE	BASS
	Combo 335	Reverb	Live				
Dual sound with a fine edge.	AMP SELECT	EFFECTS	OUTPUT CHARACTER	GAIN	TREBLE	MIDDLE	BASS
	Metal Panel	OFF	Edge				
Add chorus to the backing part and play a right-hand solo with reverb, for that typical American rock sound.	AMP SELECT	EFFECTS	OUTPUT CHARACTER	GAIN	TREBLE	MIDDLE	BASS
	Black Bottom	Chorus	Live				
Using a single-coil front pickup, you can get that "woman tone".	AMP SELECT	EFFECTS	OUTPUT CHARACTER	GAIN	TREBLE	MIDDLE	BASS
	Modern Lead	Reverb	Punch				
Play the left handed guitar with your teeth...?	AMP SELECT	EFFECTS	OUTPUT CHARACTER	GAIN	TREBLE	MIDDLE	BASS
	Fuzz Stack	OFF	Edge				

Sample Settings (MTR RECORDING)

The examples shown below are for use of the GM-200 with a multi-track recorder.

- Set the **ZNR** and **MASTER LEVEL** controls as required.
- When wishing to use the settings with a guitar amp, try setting the **OUTPUT CHARACTER** knob to "GUITAR AMP".

Clean chorus for backing, well matched to single-coil halftones.	AMP SELECT	EFFECTS	OUTPUT CHARACTER	GAIN	TREBLE	MIDDLE	BASS
	American Clean	Chorus	Wide				
The ideal setting for slow hand songs.	AMP SELECT	EFFECTS	OUTPUT CHARACTER	GAIN	TREBLE	MIDDLE	BASS
	Twin Drive	Chorus	Air				
Become the king of blues.	AMP SELECT	EFFECTS	OUTPUT CHARACTER	GAIN	TREBLE	MIDDLE	BASS
	Blues Tweed	Reverb	Air				
Modern class A sound, for playing low-position chords to the max.	AMP SELECT	EFFECTS	OUTPUT CHARACTER	GAIN	TREBLE	MIDDLE	BASS
	Class A Combo	OFF	Wide				
Seventies style hard rock sound, perfectly matched to organ playing.	AMP SELECT	EFFECTS	OUTPUT CHARACTER	GAIN	TREBLE	MIDDLE	BASS
	British Crunch	Reverb	Air				
British stack amp sound, for that real metal ring.	AMP SELECT	EFFECTS	OUTPUT CHARACTER	GAIN	TREBLE	MIDDLE	BASS
	British Drive	Chorus	Air				
Mr. 335 fusion sound.	AMP SELECT	EFFECTS	OUTPUT CHARACTER	GAIN	TREBLE	MIDDLE	BASS
	Combo 335	Chorus	Air				
With ZNR turned up, coast through those tricky riffs.	AMP SELECT	EFFECTS	OUTPUT CHARACTER	GAIN	TREBLE	MIDDLE	BASS
	Metal Panel	OFF	Air				
For "good enough" hard rock.	AMP SELECT	EFFECTS	OUTPUT CHARACTER	GAIN	TREBLE	MIDDLE	BASS
	Black Bottom	Chorus	Wide				
Lead tone for instrumental rock numbers.	AMP SELECT	EFFECTS	OUTPUT CHARACTER	GAIN	TREBLE	MIDDLE	BASS
	Modern Lead	Reverb	Air				
Are You Experienced?	AMP SELECT	EFFECTS	OUTPUT CHARACTER	GAIN	TREBLE	MIDDLE	BASS
	Fuzz Stack	Tremolo	Wide				

Troubleshooting

Symptom	Check	Remedy
No sound or very low volume	• Is correct AC adapter connected, and is POWER switch turned on?	Turn the system on as described in "Power-On".
	• Are connections between INPUT jack and guitar, OUTPUT jack and playback system established correctly?	Follow the instructions in "Getting Connected".
	• Is shielded cable defective?	Try replacing the cable.
	• Is playback system turned on? Are all volume controls at guitar and playback system set to proper levels?	Turn amplifier on and adjust controls.
	• Is MASTER LEVEL control turned down?	Set MASTER LEVEL control to suitable level.
Batteries are used up quickly	• Is ZNR setting appropriate?	Set ZNR control to suitable position, so that attack and decay does not sound unnatural.
	• Are manganese batteries being used?	Use alkaline batteries.

Specifications

Built-in programs

11 amp types
3-band tone control
11 output character types
4 effects
ZNR

Sampling frequency A/D converter D/A converter

40 kHz
20 bit, 64 times oversampling
20 bit, 128 times oversampling

INPUT

INPUT Standard mono phone jack x 1
Input impedance 480 kilohms
Gain switch HIGH: for electric guitars with passive type pickups
LOW: for electric guitars with active type pickups
MIX IN Mini stereo phone jack
Input impedance 10 kilohms
Rated input level -10 dBm

Outputs

RCA type phono jacks
Output impedance 600 ohms
Rated output level -10 dBm to +4 dBm

Line/headphone output
Standard stereo phone jack (doubles as headphone jack)
Output impedance 33 ohms
Rated output level -10 dBm to +4 dBm (load impedance 10 kilohms or more)

Power requirements

Supplied AC adapter
9V DC, center minus (AD-0006)
Six IEC R6 (size AA) batteries
Battery life: 10 hours continuous operation (alkaline batteries)

Dimensions

215 (W) x 175 (D) x 65 (H) mm

Weight

600 g (without batteries)

* 0 dBm = 0.775 Vrms

* Design and specifications subject to change without notice.

ZOOM[®]
CATCH US IF YOU CAN

ZOOM CORPORATION

NOAH Bldg., 2-10-2, Miyanishi-cho, Fuchu-shi, Tokyo 183-0022, Japan

PHONE: +81-42-369-7116

FAX: +81-42-369-7115

Web Site: <http://www.zoom.co.jp>