

## F2 Control

version 1.0

### Operation Manual



---

# Copyrights

---

iPadOS is a trademark or registered trademark of Apple Inc.

App Store is a service mark of Apple Inc.

iOS is a trademark or registered trademark of Cisco Systems, Inc. in the USA and other countries and is used under license.

Android™ and Google Play are trademarks or registered trademarks of Google LLC.

The Bluetooth® word mark and logo are registered trademarks of Bluetooth SIG, Inc., and these marks are used under license by Zoom Corporation.

Product names, registered trademarks and company names in this document are the property of their respective companies. All trademarks and registered trademarks in this document are for identification purposes only and are not intended to infringe on the copyrights of their respective owners.

Recording from copyrighted sources, including CDs, records, tapes, live performances, video works and broadcasts, without permission of the copyright holder for any purpose other than personal use is prohibited by law. Zoom Corporation will not assume any responsibility related to infringements of copyrights.

---

# Contents

---

<b>Copyrights</b> .....	<b>2</b>
<b>Contents</b> .....	<b>2</b>
<b>Installing F2 Control</b> .....	<b>3</b>
iOS/iPadOS device .....	3
Android device.....	3
<b>Connecting with an F2-BT</b> .....	<b>4</b>
<b>Recording</b> .....	<b>5</b>
Home/Recording Screen .....	5
Menu items related to recording .....	6
Adjusting output volume .....	7
Recording .....	8
<b>Playing recordings</b> .....	<b>9</b>
Playback Screen .....	9
Selecting files for playback .....	10
Playing recordings .....	11
<b>Managing files</b> .....	<b>12</b>
Showing the contents of SD cards.....	12
Working with files .....	13
<b>Inputting characters</b> .....	<b>14</b>
<b>System settings</b> .....	<b>15</b>

---

# Installing F2 Control

---

## ● iOS/iPadOS device

- 1.** Open the App Store on the iOS/iPadOS device and search for "F2 Control".
- 2.** Tap "GET" on the F2 Control screen.  
This will install F2 Control on the device.

## ● Android device

- 1.** Open the Google Play Store on the Android device and search for "F2 Control".
- 2.** Tap "INSTALL" on the F2 Control screen.  
This will install F2 Control on the device.



---

# Connecting with an F2-BT

---

1. Tap the F2 Control app icon on the iOS/iPadOS/Android device.



2. Select the serial number of the F2-BT being used in the list.

Check the serial number on the back of the F2-BT.

Connection completes after "Connecting" appears on the iOS/iPadOS/Android device.

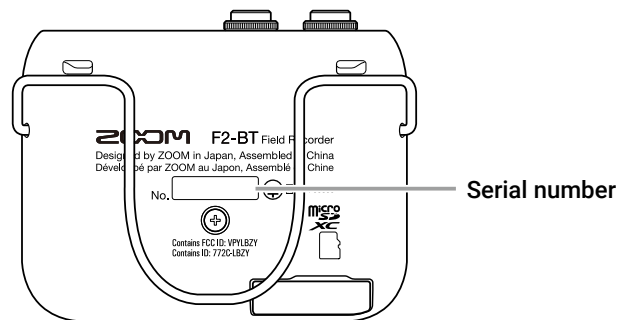
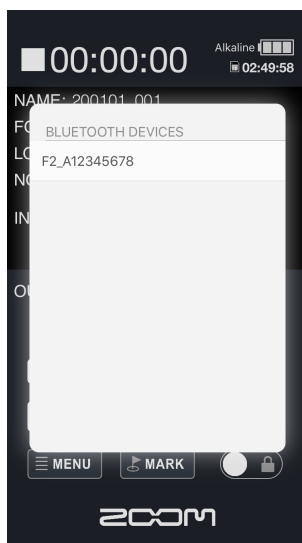

## HINT

- If connection is not successful, move the device closer to the F2-BT or move both to a place where nothing interferes with radio waves and start F2 Control again. Confirm also that the Bluetooth function of the iOS/iPadOS/Android device can be used. If connection is still not possible, confirm that Bluetooth Function is set to F2 Control in F2 Editor.

# Recording

## Home/Recording Screen

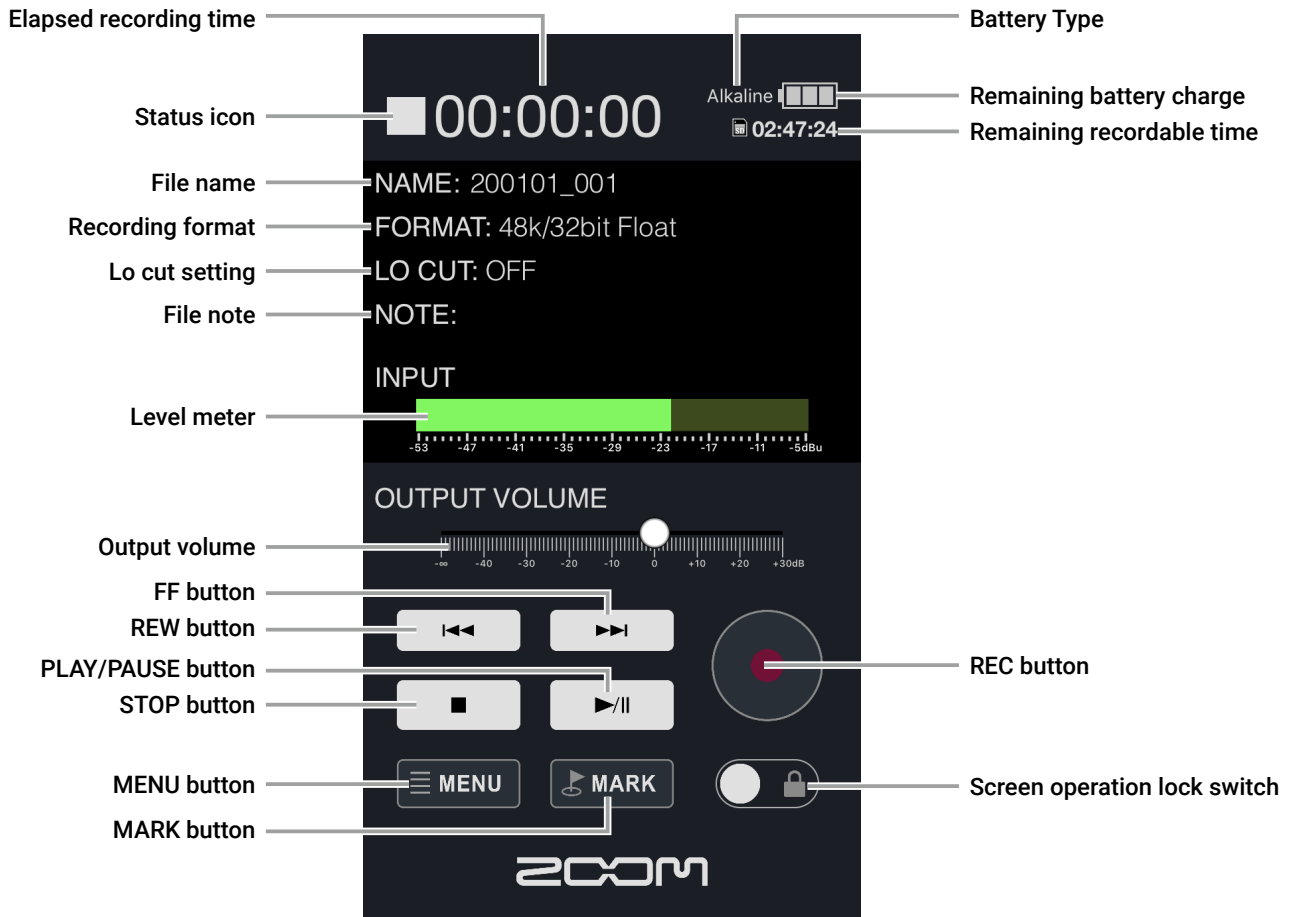

### Screen operation lock switch settings

Setting	Description
	All screen operations are enabled.
	All operations are disabled except the screen operation lock switch.

## Menu items related to recording

Various settings related to recording can be made.



1. Tap **MENU** on the Home Screen.
2. Tap an item on the Menu Screen to select it, and then change the setting.

### Lo Cut

Setting item	Description
Lo Cut	This function can reduce noise, including air-conditioning, wind and vocal pops.

### Rec Settings

Setting item	Description
Rec Format	The recording format can be selected in consideration of audio quality and file size.
Rec File Name	This sets the file name used for recorded files (→ <a href="#">"Inputting characters" on page 14</a> ).
Rec File Note	This sets the note used for recorded files (→ <a href="#">"Inputting characters" on page 14</a> ).

## Adjusting output volume

The volume used for monitoring with headphones or another device can be adjusted.

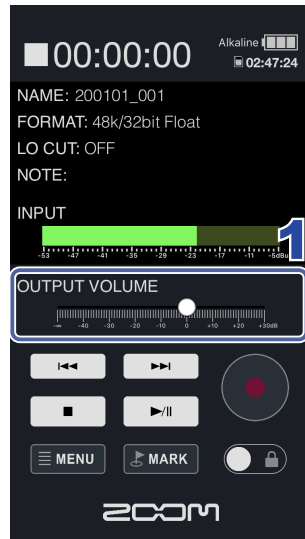

1. Slide the **OUTPUT VOLUME** on the Home Screen left and right to adjust the level.

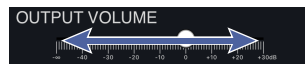

### HINT

- Double-tapping the output volume will set it to 0 dB.



# Recording



## 1. Tap on the Home Screen.

This starts recording.

### Operations during recording

Function	Operation
Add a mark	Tap  . (During playback, you can jump to places where marks have been added.)
Stop	Tap  or  .



# Playing recordings

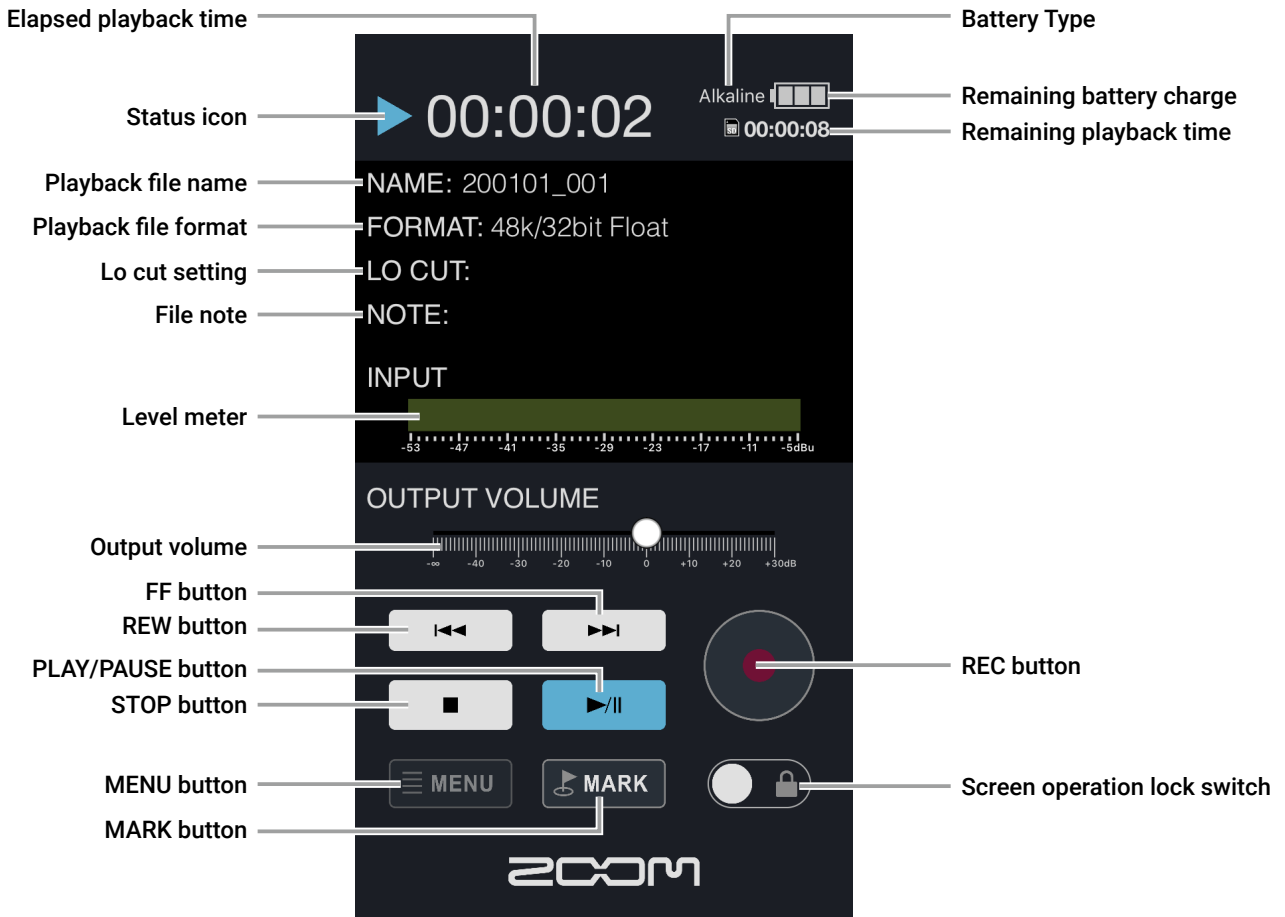

## Playback Screen



## Selecting files for playback

Files can be selected for playback.











1. Tap  or  on the Home Screen.  
This changes the playback file.

# Playing recordings



1. Tap  on the Home Screen. This starts playback of the selected file.

## Operations during playback

Function	Operation
Pause/resume	Tap  .
Search forward	Hold  .
Search backward	Hold  .
Move to the next mark (if one exists) Play the next file (if no mark exists)	Tap  .
Move to the previous mark (if one exists) Move to the beginning of the file (if no mark exists)	Tap  .
Play the previous file	Tap  twice in a row.
Add a mark	Tap  .
Stop	Tap  .

# Managing files

## Showing the contents of SD cards

Use the FINDER screen to check and edit files on the SD card in the F2-BT.

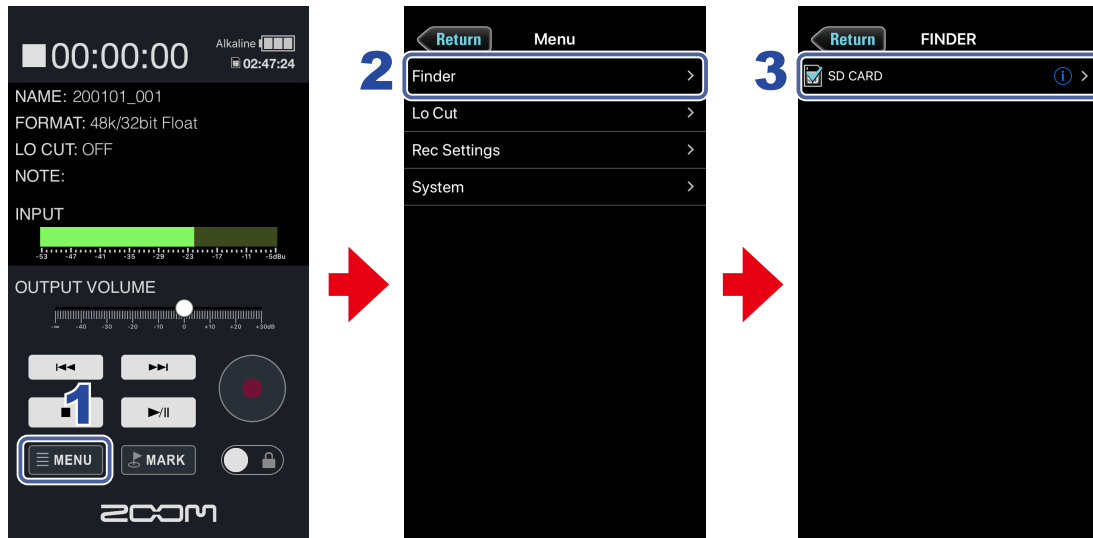

1. Tap **MENU** on the Home Screen.
2. Tap **Finder** on the Menu Screen.
3. Tap **SD CARD** on the FINDER screen.  
This opens the File List Screen.



## Working with files

Working with files, you can check their information, change their names and edit their metadata.

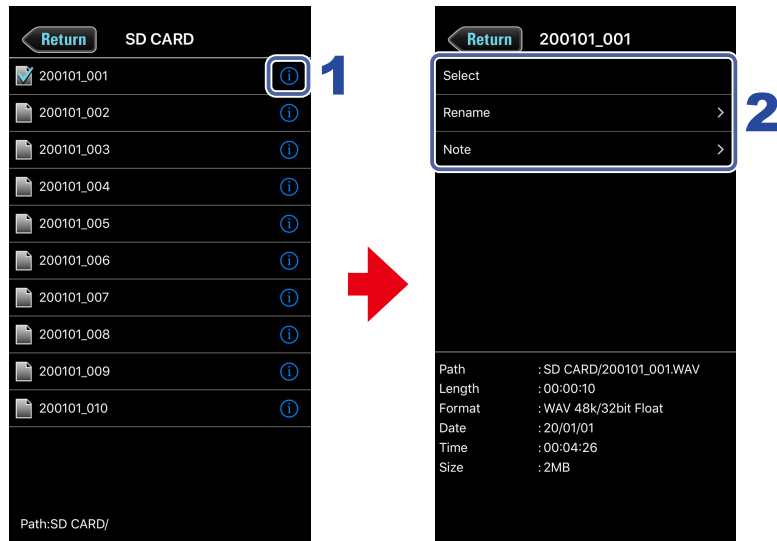

### 1. To work with a file, tap the **i** to the right of its name.

This opens the Options Screen where you can check the following information.

Selected item	Data item	Description
SD CARD	Free	Open space
	Size	Size
	Remain	Remaining recordable time
File	Path	File path
	Length	Length of time
	Format	Recording format
	Date	Date created
	Time	Time created
	Size	Size

### 2. Tap an item to change its setting or work with it.

#### File options

Setting item	Description
Select	Select the file for playback and return to the Home Screen. When an SD card is selected, the first file inside it will be selected.
Rename	Change the file name (→ <a href="#">"Inputting characters" on page 14</a> ).
Note	Check and edit the file note (→ <a href="#">"Inputting characters" on page 14</a> ).

---

# Inputting characters

---

Character input screens appear for inputting file names and notes, for example.

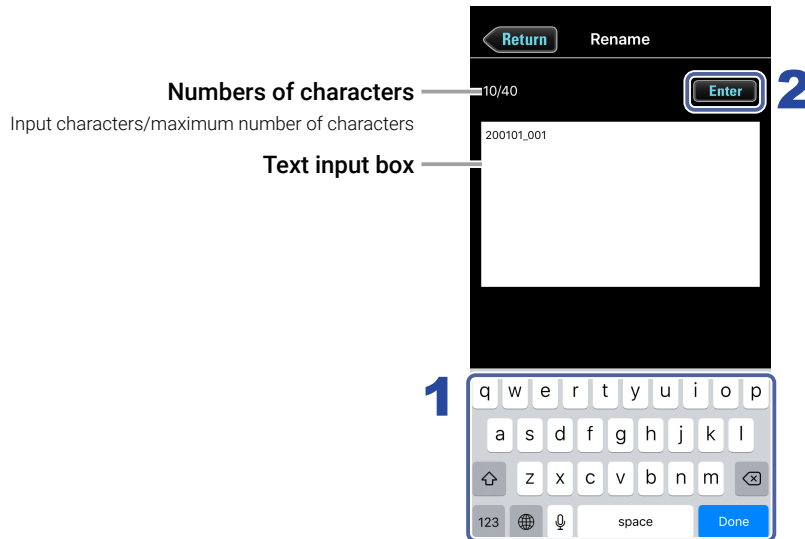

## 1. Input characters using the keyboard.

The input characters appear in the text box.

### NOTE

· The following characters can be input.

(space)! # \$ % & ' ( ) + , - 0 1 2 3 4 5 6 7 8 9 ; = @ A B C D E F G H I J K L M N O P Q R S T U V W X Y Z [ ] ^ \_ ` a b c d e f g h i j k l m n o p q r s t u v w x y z { } ~

Except when inputting a "Note", you cannot put an @ mark or a space at the beginning.

## 2. When done inputting, tap **Enter**.

Confirm the input characters.

Tap **Return** to cancel the input.

# System settings

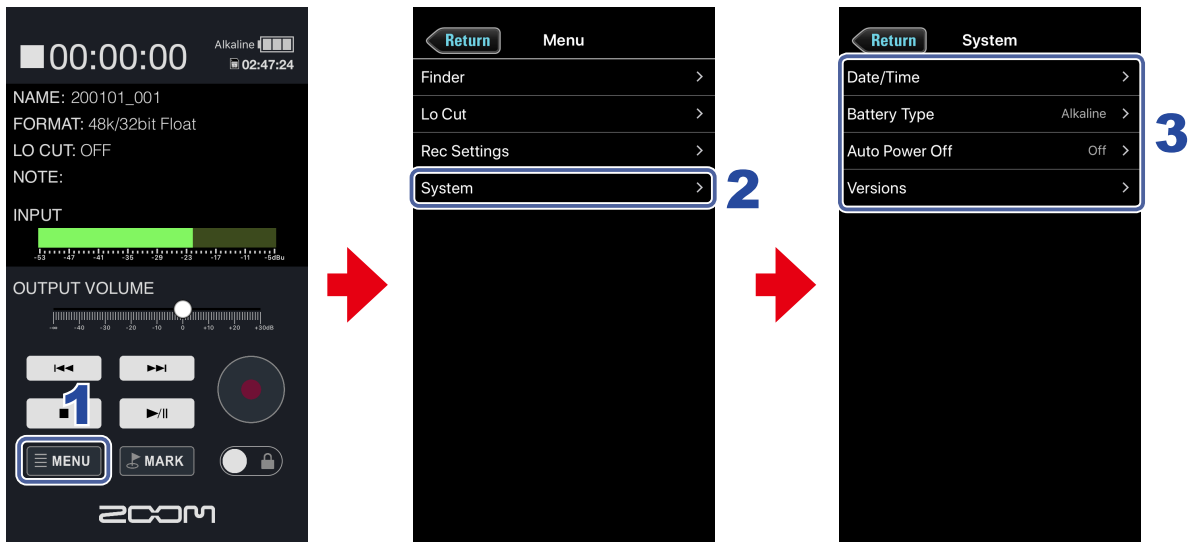

1. Tap **MENU** on the Home Screen.
2. Tap **System** on the Menu Screen.
3. Tap a setting item and then change it.

## System settings

Setting item	Description
Date/Time	Set the date and time.
Battery Type	Select the type of batteries used in the F2-BT.
Auto Power Off	Use this to set the time until the F2-BT power turns off automatically.
Versions	Check the F2-BT and F2 Control versions here.



**ZOOM CORPORATION**

4-4-3 Kanda-surugadai, Chiyoda-ku, Tokyo 101-0062 Japan

[zoomcorp.com](http://zoomcorp.com)