

# ZOOM 708II BASS

## Operation Manual

### CONTENTS

<b>USAGE AND SAFETY PRECAUTIONS</b> .....	<b>2</b>
<b>Introduction</b> .....	<b>3</b>
<b>Controls and Functions</b> .....	<b>4</b>
Top Panel .....	4
Rear Panel .....	4
<b>Preparations</b> .....	<b>6</b>
Inserting Batteries and a SmartMedia card .....	6
Getting Connected .....	7
<b>Quick Guide (Let's Play)</b> .....	<b>8</b>
<b>Listening to Patches (Play Mode Operation)</b> .....	<b>10</b>
Panel Display in Play Mode .....	10
Selecting a Patch .....	10
Using the Tuner Function .....	11
Using the Easy Edit Function .....	12
Using the Sampler Function .....	13
Using the Rhythm Function .....	16
<b>Changing the Sound of a Patch (Edit Mode)</b> .....	<b>18</b>
Patch Configuration .....	18
Basic Edit Mode Steps .....	18
Storing and Swapping Patches .....	20
<b>Other Functions</b> .....	<b>21</b>
Using the Hold Delay Function .....	21
Changing the Patch Call Method .....	23
Using the Pedal to Control an Effect .....	23
Adjusting the Expression Pedal .....	25
Storing Rhythm Patterns and Samples as Part of a Patch .....	26
Assigning a rhythm pattern to a patch .....	26
Assigning a sample to a patch .....	27
Using a SmartMedia card (Utility Mode) .....	28
Basic utility mode operation steps .....	28
Utility mode functions .....	29
All Initialize/Factory Recall .....	32
<b>Effect Types and Parameters</b> .....	<b>33</b>
PICKUP SELECTOR Module .....	33
DRIVE Module .....	33
EQ (Equalizer) Module .....	35
ZNR/D GATE (ZOOM Noise Reduction/D Gate) Module .....	35
CABINET Module .....	35
MODULATION Module .....	36
DLY/REV (Delay/Reverb) Module .....	37
TOTAL Module .....	38
<b>Troubleshooting</b> .....	<b>39</b>
<b>Specifications</b> .....	<b>39</b>
Patch List .....	40



# USAGE AND SAFETY PRECAUTIONS

## SAFETY PRECAUTIONS

In this manual, symbols are used to highlight warnings and cautions for you to read so that accidents can be prevented. The meanings of these symbols are as follows:



This symbol indicates explanations about extremely dangerous matters. If users ignore this symbol and handle the device the wrong way, serious injury or death could result.



This symbol indicates explanations about dangerous matters. If users ignore this symbol and handle the device the wrong way, bodily injury and damage to the equipment could result.

Please observe the following safety tips and precautions to ensure hazard-free use of the 708II.

### • Power requirements



Since power consumption of this unit is fairly high, we recommend the use of an AC adapter whenever possible. When powering the unit from a battery, use only an alkaline type.

### [AC adapter operation]

- Be sure to use only an AC adapter which supplies 9 V DC, 300 mA and is equipped with a "center minus" plug (Zoom AD-0006). The use of an adapter other than the specified type may damage the unit and pose a safety hazard.
- Connect the AC adapter only to an AC outlet that supplies the rated voltage required by the adapter.
- When disconnecting the AC adapter from the AC outlet, always grasp the adapter itself and do not pull at the cable.
- When not using the unit for an extended period, disconnect the AC adapter from the AC outlet.

### [Battery operation]

- Use four conventional IEC R6 (size AA) batteries (alkaline).
- The 708II cannot be used for recharging. Pay close attention to the labelling of the battery to make sure you choose the correct type.
- When not using the unit for an extended period, remove the batteries from the unit.
- If battery leakage has occurred, wipe the battery compartment and the battery terminals carefully to remove all remnants of battery fluid.
- While using the unit, the battery compartment cover should be closed.

### • Environment



Avoid using your 708II in environments where it will be exposed to:

- Extreme temperature
- High humidity or moisture
- Excessive dust or sand
- Excessive vibration or shock

### • Handling



Since the 708II is a precision electronic device, avoid applying excessive force to the switches and buttons. Also take care not to drop the unit, and do not subject it to shock or excessive pressure.

### • Alterations



Never open the case of the 708II or attempt to modify the product in any way since this can result in damage to the unit.

### • Connecting cables and input and output jacks



You should always turn off the power to the 708II and all other equipment before connecting or disconnecting any cables. Also make sure to disconnect all cables and the AC adapter before moving the 708II.

## Usage Precautions

### • Electrical interference

For safety considerations, the 708II has been designed to provide maximum protection against the emission of electromagnetic radiation from inside the device, and protection from external interference. However, equipment that is very susceptible to interference or that emits powerful electromagnetic waves should not be placed near the 708II, as the possibility of interference cannot be ruled out entirely.

With any type of digital control device, the 708II included, electromagnetic interference can cause malfunctioning and can corrupt or destroy data. Care should be taken to minimize the risk of damage.

### • Cleaning

Use a soft, dry cloth to clean the 708II. If necessary, slightly moisten the cloth. Do not use abrasive cleanser, wax, or solvents (such as paint thinner or cleaning alcohol), since these may dull the finish or damage the surface.

Please keep this manual in a convenient place for future reference.

# Introduction

Thank you for purchasing the **ZOOM 708II BASS** (subsequently referred to as "*the 708II*"). The 708II is a sophisticated multi-effect processor for bass with the following attractive features.

- **Versatile array of effects**

The Variable Architecture Modeling System (VAMS) developed by ZOOM modifies the internal configuration of the unit to achieve exactly the desired sound. The 708II provides 69 choices, including typical bass amplifier sounds, modulation effects such as chorus and flanger, reverberation effects such as reverb and delay, and simulation of speaker cabinets.

- **120 great sounding patches**

Effect module setting combinations can be stored as patches. The 708II offers 60 patches which can be freely modified by the user, plus 60 preset patches. These settings will let you make great music straight away.

- **Sophisticated amp modeling and bass effects**

In addition to the sound of vintage bass amps, the 708II gives easy access to often used bass settings via 33 types of amp modeling and bass effects. Dedicated knobs and keys let you select the desired effect quickly and without fuss. Special effects that make your bass guitar sound like a synthesizer bass or fretless bass are also provided.

- **Designed for use on stage**

The 708II can be powered from an AC adapter or batteries. With one set of alkaline batteries, the unit will operate continuously for up to 11 hours. The large display showing patch names, and the built-in expression pedal for fine-tuning the sound are great for live performances.

- **Knobs provide direct editing feel**

Various aspects (effect parameters) that control the sound of a module can be directly modified with three handy knobs. The Easy Edit feature lets you tweak the knobs for adjusting parameters also during play. Of course, you can store the results in your own patch.

- **Sampling feature allows up to 4 minutes recording (with 16 MB SmartMedia card)**

A bass guitar phrase or the signal from an input source such as a CD player can be sampled for up to 6 seconds and stored in the internal memory. When using a 16 MB SmartMedia card, you can record up to 60 samples or 4 minutes of music. A recorded sample can even be played back at a slower speed without altering the pitch. This is a great tool for enhancing a live performance or copying a fast-playing lick.

- **SmartMedia card allows unlimited number of patches and samples**

Patches and samples can be stored on separately available SmartMedia cards (up to 60 patches x 5 groups / 60 samples per card). Stored data can be read back into the unit at any time. This gives you unlimited potential for building a library of patches and samples.

- **Integrated rhythm function**

60 built-in rhythm patterns using natural-sounding PCM sources are available, which is great for practice or a quick jam session.

- **Link samples, rhythm, pedal settings to patches**

The selection of rhythm patterns and samples can be stored for each patch individually, allowing synchronized operation when switching patches. Even the pedal adjustment range can be memorized for a patch.

In order to get the most out of this sophisticated product, please read this manual carefully before use.

We recommend that you keep the manual at hand for future reference.

# Controls and Functions

This section identifies the parts of the 708II and describes preparations for use.

## Top Panel

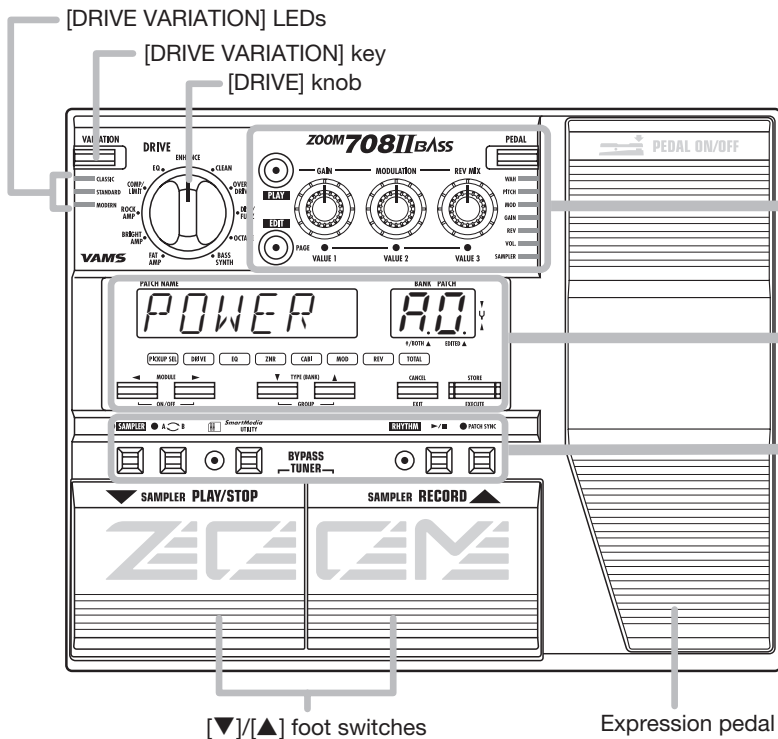

## Rear Panel

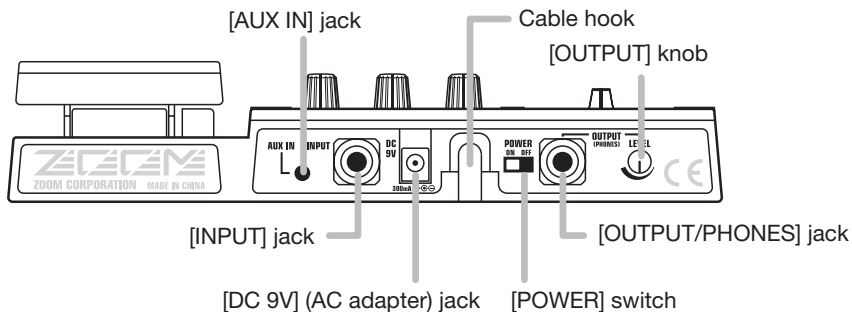

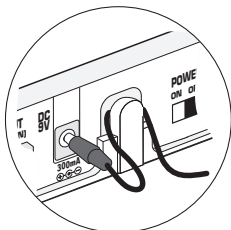
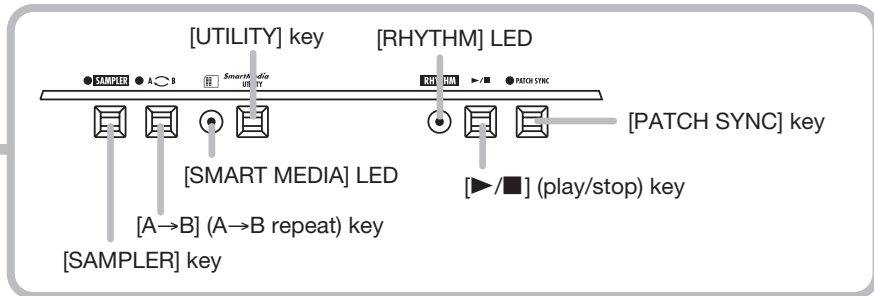
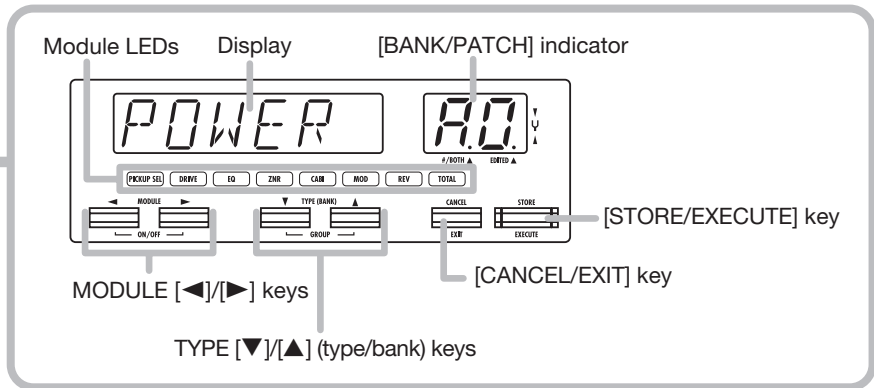
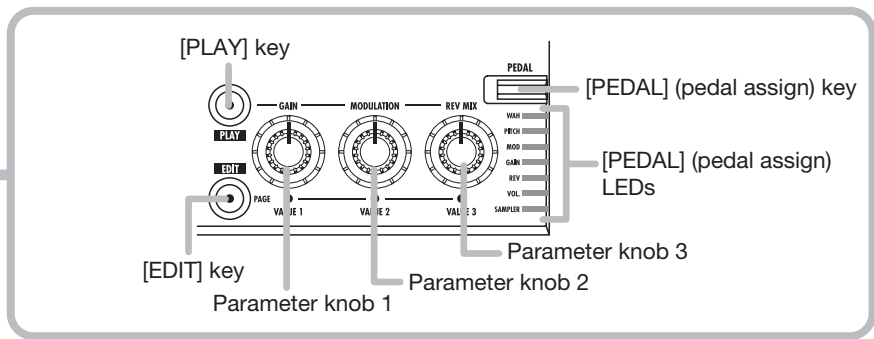

Loop the cable of the AC adapter around the hook as shown in the diagram before connecting it to the [DC 9V] jack. This will prevent the plug from being disconnected if the cable is accidentally pulled.

# Preparations

## Inserting Batteries and a SmartMedia card

When wishing to power the 708II from batteries, insert them as shown below. When wishing to store patch data or sample data on a SmartMedia card, insert the card as shown below.

1. Turn the unit over and open the battery compartment cover.

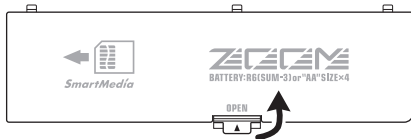

2. Insert four fresh IEC R6 (size AA) batteries into the battery compartment. The use of alkaline batteries is recommended.

The correct battery orientation is indicated inside the battery compartment.

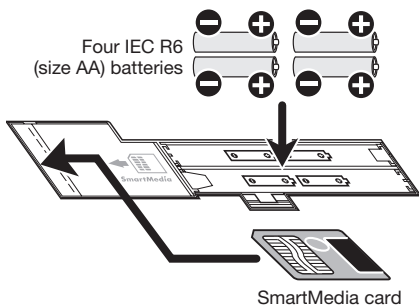

3. To store patch and sample data, insert a SmartMedia card into the card slot, as shown above.

### ◆ Caution ◆

- If the card is inserted upside down or with wrong orientation, it does not go all the way in. Do not try to force the card in, because this will damage the card.
- Never insert or remove the SmartMedia card while power to the unit is turned on. Otherwise all data on the card may be lost.
- Standard SmartMedia cards (designed for 3.3V) with a capacity from 16 – 128 MB can be used.
- When wishing to use a SmartMedia card that has been formatted in other equipment such as a computer or digital camera, you must format the card again in the 708II, as described on page 31.
- To store the contents of a SmartMedia card in a computer, a SmartMedia card reader/writer is required.

4. Close the battery compartment cover.

### ● NOTE ●

- If the indication "BATT" appears on the display, the batteries are exhausted. Replace the batteries as soon as possible.



- When not using the unit for an extended period, remove the batteries to prevent the possibility of damage by leaking battery fluid.

## Getting Connected

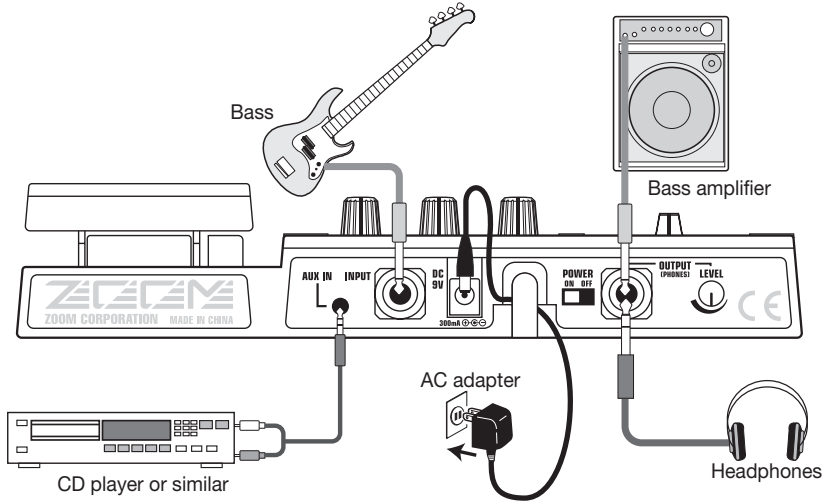

1. Make sure that the amplifier and the 708II are off.

Turn the volume at the amplifier to minimum.

2. To power the unit from the AC adapter, insert the small plug of the adapter cable into the [DC 9V] jack on the 708II. Then plug the adapter into an outlet.
3. Connect the bass to the [INPUT] jack of the 708II, using a mono cable.
4. Connect the [OUTPUT/PHONES] jack of the 708II to the bass amplifier, using a mono cable.

You can also use a Y cable to supply the signal in stereo to two amplifiers.

5. To monitor the sound with headphones, plug the phones into the [OUTPUT/PHONES] jack.
6. Turn power on in the following order: 708II → amplifier.

### NOTE

If you turn the 708II on while the amplifier is already powered up, damage to the speaker may result. Always turn power to the amplifier on last.

7. Raise the volume setting of the instrument and amplifier, and adjust the [OUTPUT] knob on the rear panel of the 708II.

# Quick Guide (Let's Play)

Immediately after being turned on, the 708II is in the so-called "play mode". The Quick Guide explains the basic steps in play mode. This will let you use the unit right away.

## Selecting a patch

- 1 In play mode, press one of the [▼]/[▲] foot switches.

In play mode, the information shown at right appears on the display and the [BANK/PATCH] indicator.

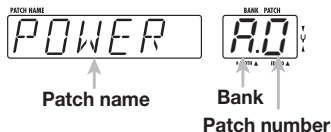

- 2 To directly switch the bank, press one of the TYPE [▼]/[▲] keys.

Each push of a key switches to the next bank.

- ◆ For a detailed explanation of patch switching, see p. 10.
- ◆ To set up the unit so that the patch sound is switched only after confirmation, see p. 23.

## Patches, groups and banks

A combination of 708II effects, each with distinct parameter settings, is called a patch. Patches are organized in banks (A - F, 0 - 5) and patch numbers (0 - 9). It is also possible to assign a name of up to six characters to a patch.

The patches of the 708II are stored in two different groups: the USER group (banks A - F) for read-and-write patches that can be freely overwritten by the user, and the PRESET group (0 - 5) for read-only patches that cannot be changed by the user. There are 60 patches in each group, resulting in a total of 120 patches.

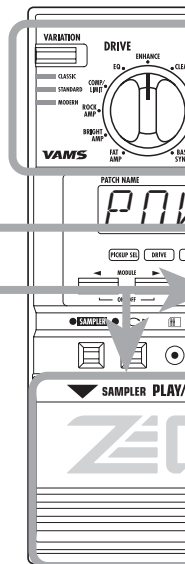
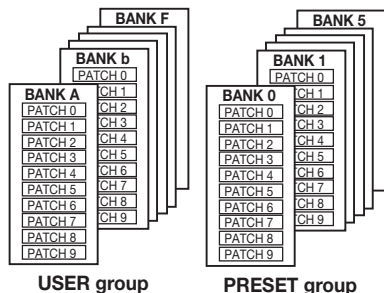

## Altering an effect with the pedal

- 1 To alter an effect in real time, move the expression pedal while playing your instrument.



The effect depth or volume changes as you move the pedal. Which parameter changes depends on the patch.

- 2 To switch the effect module on or off, push the expression pedal fully down.



The expression pedal also incorporates a push-down switch that allows on/off control of a specific effect module.

- ◆ For details on selecting the effect module to be controlled by the pedal, see p. 23.



## Changing the sound of a patch

- 1 While playing your instrument, operate the knobs on the panel.

Each knob controls a certain parameter, as indicated below.

### [DRIVE VARIATION] key

#### [DRIVE] knob

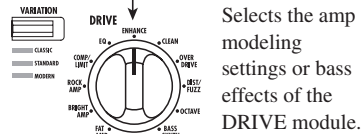

#### Parameter knob 1

Adjusts the gain or compressor sensitivity of the DRIVE module.

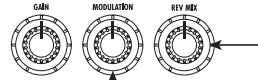

#### Parameter knob 2

Adjusts the modulation rate of chorus, flanger, and similar effects. For some patches, the knob adjusts the echo level.

#### Parameter knob 3

Adjusts the reverb or delay level.

- ◆ For a list of parameters adjusted with the knobs, see p. 33 – 38.
- ◆ To edit a patch more in detail, see p. 18.

## Storing an effect

- 1 Press the [STORE/EXECUTE] key.

The 708II goes into store standby mode.

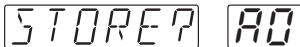

If a patch from the PRESET group was selected, "A0" in the USER group is automatically selected as store target.

- 2 Use the [▼]/[▲] foot switches to select the store target bank and patch number.

- 3 To carry out the store operation, press the [STORE/EXECUTE] key once more.

To cancel the process, press the [CANCEL/EXIT] key.

- ◆ For a detailed explanation of patch storing, see p. 20.
- ◆ For information on how to return the USER group patches to the factory default condition, see p. 32.

# Listening to Patches (Play Mode Operation)

The condition where you call up patches stored in the memory of the 708II and use them for playing your instrument is called "play mode". This is the condition the unit is in when you turn the power on. The various operations possible in play mode are described in this section.

## Panel Display in Play Mode

In play mode, the panel shows the following information.

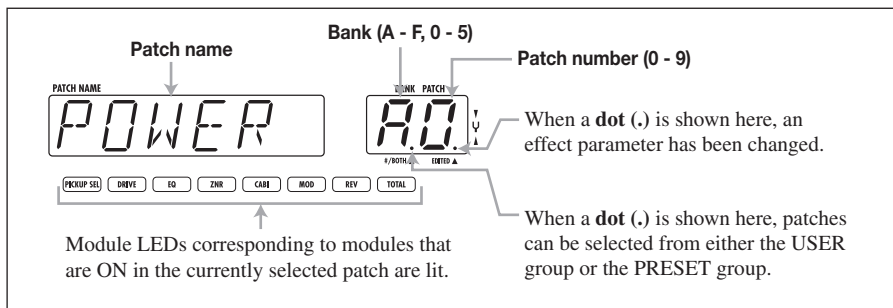

## Selecting a Patch

### 1. In play mode, press one of the [▼]/[▲] foot switches.

Pressing the [▲] foot switch moves to the next higher patch, and pressing the [▼] foot switch moves to the next lower patch.

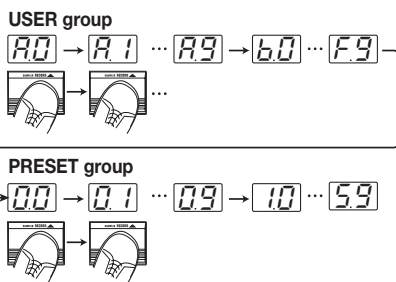

### 2. To directly switch the bank, use the TYPE [▼]/[▲] keys.

Pressing the TYPE [▲] key moves to the next higher bank, and pressing the TYPE [▼] key moves to the next lower bank.

### NOTE

While playing a rhythm pattern, direct bank selection is not available.

### 3. It is also possible to set up the unit so that only patches from the USER group or from the PRESET group are switched. To do this, press both TYPE [▼]/[▲] keys together.

With each push, the group from which patches can be selected is toggled as follows.

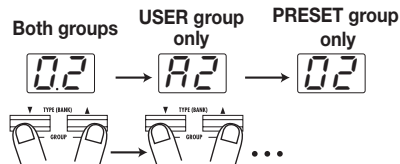

### HINT

To set up the unit so that the patch sound is switched only after confirmation, see p. 23.

## Using the Tuner Function

The 708II incorporates an auto-chromatic tuner for bass. To use the tuner function, the built-in effects must be bypassed (temporarily turned off) or muted (direct sound and effect sound turned off).

### 1. To set the 708II to the bypass (mute) condition, press and release both [▼]/[▲] foot switches in play mode.

When you press and immediately release both foot switches, the 708II goes into bypass mode.

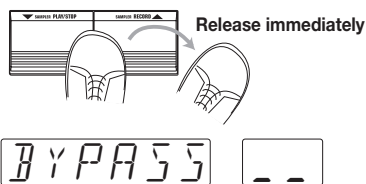

While the 708II is in the bypass condition, all effects are off and only the direct sound is output. The expression pedal works as a volume pedal.

When you press and hold both foot switches for at least 1 second and then release them, the 708II goes into mute mode.

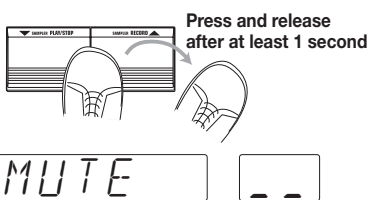

While the 708II is in the mute condition, there is no sound output from the [OUTPUT/PHONES] jack.

### 2. Play the open string you want to tune.

The [BANK/PATCH] indicator shows the note which is closest to the current pitch. Tune your instrument until the note indication shows the desired note.

The note is shown on the left part of the indicator

A = $\overset{\frown}{A}$	D = $\overset{\frown}{d}$	G = $\overset{\frown}{G}$
A# = $\overset{\frown}{A\#}$	D# = $\overset{\frown}{d\#}$	G# = $\overset{\frown}{G\#}$
B = $\overset{\frown}{b}$	E = $\overset{\frown}{E}$	
C = $\overset{\frown}{C}$	F = $\overset{\frown}{F}$	
C# = $\overset{\frown}{C\#}$	F# = $\overset{\frown}{F\#}$	

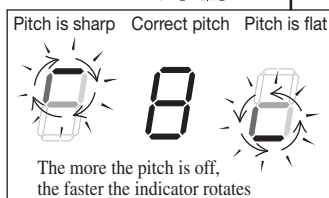

To the right of the note, a symbol indicates by how much the tuning is off.

### 3. To change the reference pitch of the tuner, use the TYPE [▼]/[▲] keys.

The current reference pitch is briefly shown on the display. The default setting after power-on is center A = 440 Hz.



Reference pitch value

### 4. While the reference pitch is shown, you can change the pitch by pressing the TYPE [▼]/[▲] keys.

The available setting range is 435 – 445 Hz in 1-Hz steps. When the 708II is turned off and on again, it will be reset to 440 Hz.

### 5. Press one of the [▼]/[▲] foot switches.

The 708II returns to the play mode.

## Using the Easy Edit Function

The 708II incorporates a function called "Easy Edit" that allows adjusting some effect parameters during play. This is done with the parameter knobs 1 – 3, the [DRIVE VARIATION] key, and the [DRIVE] knob on the front panel.

### 1. To change the sound of a patch in play mode, operate parameter knobs 1 – 3.

The parameters controlled by the knobs are as follows.

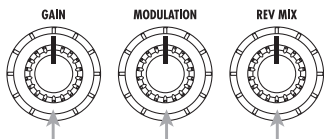

#### Parameter knob 1

Adjusts a major parameter of the DRIVE module (such as gain and compressor sensitivity).

#### Parameter knob 2

Adjusts a major parameter of the MOD module (such as chorus depth).

#### Parameter knob 3

Adjusts a major parameter of the REV module (such as delay or reverb amount).

The actual parameter controlled by parameter knobs 1 – 3 depends on the effect selected for the current effect module.

When a knob is turned, the current setting of the relevant parameter is shown on the BANK/PATCH indicator, and a dot (.) appears at the "EDITED" position. This indicates that the parameter has been changed. If the parameter is returned to the original setting, the dot disappears.



When a dot (.) is shown here, the effect parameter has been changed.

### 2. Use the [DRIVE] knob and [DRIVE VARIATION] key to select the effect to be used for the DRIVE module.

The DRIVE module contains effects that duplicate the sound of famous bass amplifiers as well as other often used effects for bass guitars. The effects of the DRIVE module can be directly selected with the [DRIVE] knob and [DRIVE VARIATION] key.

The [DRIVE] knob selects the general category (amp type or effect type), and the [DRIVE VARIATION] key selects one of several variations for that effect. Each push of the [DRIVE VARIATION] key cycles through the CLASSIC → STANDARD → MODERN settings, and the corresponding LED lights up.

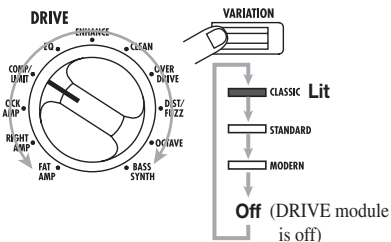

#### HINT

- For an explanation of DRIVE module effects, see p. 33.
- In play mode, you can also use the MODULE [◀]/[▶] keys to edit the PATLVL parameter (volume level for each patch).

### 3. To store an edited patch, carry out the steps for storing (→ p. 20).

Note that if another patch is called up without storing the edited patch, the edited contents will be lost.

#### NOTE

While playing a rhythm pattern, the parameter knobs 1 – 3 adjust rhythm parameters.

## Using the Sampler Function

The 708II incorporates a sampler function that allows recording the input signal in the internal memory or on a SmartMedia card.

This can be used to record a phrase from the bass connected to the [INPUT] jack or the sound from an external source such as a CD player connected to the [AUX IN] jack. When using the internal memory, the maximum recording duration is 6 seconds (1 sample). When using a 16 MB SmartMedia card, up to 4 minutes (maximum 60 samples) can be recorded. A recorded phrase can also be played at slower speed without changing the pitch. This is convenient to copy a fast-played phrase from a CD.

For playing a sample, you can choose between two modes: "one-shot playback" where the sampled phrase is played once when you operate a key or pedal, and "loop playback", where the sampled phrase continues to play until stopped.

- 1. When wishing to use a SmartMedia card, turn power to the 708II off, insert the SmartMedia card into the card slot, and then turn power on again. (For information on inserting a SmartMedia card, see p. 6.)**

### NOTE

- Before using a SmartMedia card in the 708II, it must be formatted (→ p.31).
- Never insert or remove the SmartMedia card while power to the unit is turned on. Otherwise all data on the card may be lost.

- 2. Connect the input source to the [INPUT] jack or [AUX IN] jack.**

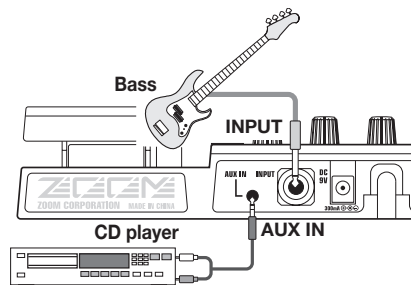

- 3. Turn power to the 708II on and press the [SAMPLER] key in play mode.**

For patches in which the expression pedal is assigned to SAMPLER, the sampler function

can also be turned on by pushing the pedal all the way down (→ p.24).

The subsequent steps are slightly different, depending on whether a SmartMedia card is inserted or not.

### SmartMedia card not inserted

The following indication appears on the display, and the unit goes into the sampler standby mode. Proceed to step 4.

SAMPLE

### SmartMedia card inserted

The following indication appears on the display, and the unit goes into the sampler standby mode. The sample number is shown on the [BANK/PATCH] indicator.

SP NO 1

When using a SmartMedia card, the samples on the card are assigned numbers from 1 – 60. If necessary, use parameter knob 1 to select a number. Then proceed to step 4.



### NOTE

- If the indication "NO" is followed by a "\*", a sample is recorded in that number.
- If you select a number in which a sample has already been recorded, the previous sample will be overwritten. Be careful not to overwrite a sample that you wish to keep.

### HINT

- For information on how to assign a sample to a patch when storing, see p. 27.
- For information on how to delete unwanted samples from a SmartMedia card, see p. 31

#### 4. Use the TYPE [▼]/[▲] keys to select "BASS" or "AUX" as input source.

When you press one of the TYPE [▼]/[▲] keys, the currently selected input source is shown on the display. Select one of the following two sources.

- **BASS** Signal from [INPUT] jack
- **AUX** Signal from [AUX1 IN] jack

### HINT

- If "BASS" is selected, the signal after passing the effects is sampled. If "AUX" is selected, the effects are bypassed.
- When recording from the [AUX IN] jack, you can minimize noise and distortion by turning the [OUTPUT] knob up past the midway point and adjusting the output level of the external source so that the volume is about equal to that of a bass.
- After recording, you can use the SP LVL parameter to control the playback level of the sample.

#### 5. Press the [▲] foot switch and play the phrase you want to record (or start playback at the external source component).

During sampling, the indication "REC" is shown on the display. The module LEDs on the panel show the elapsed sampling time.



### NOTE

- When sampling to internal memory, sampling ends when all module LEDs are lit.
- When sampling to SmartMedia card, the module LEDs go through the cycle repeatedly.

#### 6. To stop sampling, press the [▼] foot switch.

If you do not press any key after starting to sample, sampling automatically ends when the maximum sampling time is up (6 seconds with internal memory, 4 minutes with a 16 MB SmartMedia card).

#### 7. Use parameter knob 2 to select the sample playback mode.

When you operate parameter knob 2, the indication "SPMODE" appears on the display. The [BANK/PATCH] indicator shows the playback mode. The following settings are available.



- **n1** Normal speed playback
- **n2** Half tempo, half pitch playback
- **P2** Half tempo, normal pitch playback
- **n4** Quarter tempo, quarter pitch playback
- **P4** Quarter tempo, normal pitch playback

#### 8. Use the foot switches and panel keys to control playback/stop/record/rewind/fast-forward.

While the sampler function is on, you can use the foot switches and panel keys for one-shot playback.

MODULE [◀] Key Rewind      MODULE [▶] Key Fast-forward

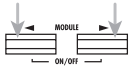

Press both keys to return to the start of the sample

[▼] foot switch Play/Stop      [▲] foot switch Start sampling

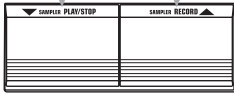

**9. If necessary, you can adjust the sample playback level with parameter knob 3.**

When you operate parameter knob 3, the indication "SP LVL" appears on the display. The [BANK/PATCH] indicator shows the sample playback level, using a range from 0 - 30. Adjust the level to obtain a suitable playback volume.

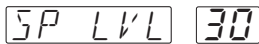

**HINT**

You can also adjust the playback level with the expression pedal.

**10. To carry out loop playback of a specific interval, play the sample and press the [A→B] key at the desired start point.**

The [A→B] LED flashes and loop playback is enabled. The point at which you pressed the [A→B] key is taken as the loop start point. If no end point has been set, the end of the sample is taken as the end point.

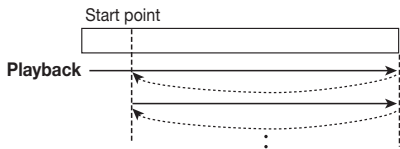

**11. If you wish to set the loop end point, press the [A→B] key once more during loop playback of the sample.**

The [A→B] LED now stays constantly lit, and the point at which you pressed the [A→B] key is taken as the loop end point.

When the end point has been set, loop playback is carried out between the start and end points.

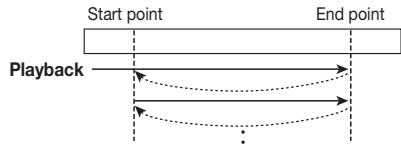

**12. To cancel loop playback, press the [A→B] key once more (or change the sample number).**

The [A→B] LED goes out, and the unit returns to normal one-shot playback.

**13. To terminate the sampler function, press the [SAMPLER] key while the sampler is stopped, or push the expression pedal all the way down.**

The unit returns to normal play mode.

**NOTE**

- The start point and end point settings are reset when you change the sample number or switch the sampler function off or on.
- The sampler function cannot be used together with the rhythm pattern function.
- While the sampler function is on, the MOD module and REV module cannot be used. (They are automatically set to OFF.)
- When sampling to a SmartMedia card, the sampled data are stored on the SmartMedia card automatically. There is no need for the user to perform any steps for storing.
- If you have sampled to the internal memory, you cannot save the sample.

## Using the Rhythm Function

The 708II incorporates 60 rhythm patterns which can be selected for playback. This is convenient for parts practice or a quick jam session.

### 1. Press the [▶/■] key in play mode.

Rhythm pattern playback starts. The display shows the currently selected pattern, and the [BANK/PATCH] indicator briefly shows the pattern number. The [RHYTHM] LED flashes in sync with the rhythm pattern tempo.



### 2. Use parameter knobs 1 – 3 to control rhythm pattern play.

In play mode, parameter knobs 1 – 3 have the following functions.

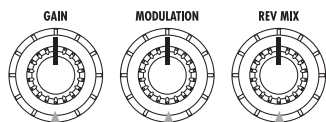

**Parameter knob 1**  
Changes the rhythm pattern type.

**Parameter knob 2**  
Changes the rhythm pattern tempo.

**Parameter knob 3**  
Changes the rhythm pattern volume.

When you operate a parameter knob during rhythm pattern play, the indication on the display and [BANK/PATCH] indicator changes temporarily.



Parameter knob 1



Parameter knob 2



Parameter knob 3

### **HINT**

- You can also switch patches during rhythm pattern playback.
- You can also play a rhythm pattern in the bypass/mute condition and in the edit mode, but the parameter knobs cannot be used to control the rhythm pattern in this case.
- The tempo and volume settings revert to the default condition when the unit is turned off and on again.
- You can also use the TYPE [▼]/[▲] keys to change the pattern type.
- You can also change the tempo with the MODULE [◀]/[▶] keys.

### 3. To stop rhythm pattern playback, press the [▶/■] key once more.

It is also possible to store a rhythm pattern for specific patches. When you have assigned rhythm patterns to patches and you set the [PATCH SYNC] key to On, rhythm patterns will be switched together with the patches (→ p. 26).



## Rhythm pattern list

Rhythm pattern	Display indication	[BANK/PATCH] indicator		Rhythm pattern	Display indication	[BANK/PATCH] indicator	
8BEAT1	<i>8BEAT</i>	1	Basic patterns	METRO (triple time)	<i>METRO</i>	3	Metronome patterns
8BEAT2	<i>8BEAT</i>	2		METRO (quadruple time)	<i>METRO</i>	4	
8BEAT3	<i>8BEAT</i>	3		METRO (quintuple time)	<i>METRO</i>	5	
8BEATSHUFFLE	<i>8SHUFL</i>			METRO	<i>METRO</i>		Intro patterns
16BEAT1	<i>16BEAT</i>	1		INTRO1	<i>INTRO</i>	1	
16BEAT2	<i>16BEAT</i>	2		INTRO2	<i>INTRO</i>	2	
16BEAT3	<i>16BEAT</i>	3		INTRO3	<i>INTRO</i>	3	
16BEATSHUFFLE	<i>16SHFL</i>			INTRO4	<i>INTRO</i>	4	
3/4	3/4			INTRO5	<i>INTRO</i>	5	
6/8ROCK	<i>6/8</i>			INTRO6	<i>INTRO</i>	6	
5/4	5/4	1		INTRO7	<i>INTRO</i>	7	
5/4ROCK	<i>5/4</i>	2		INTRO8	<i>INTRO</i>	8	
ROCK'nROLL1	<i>R'nR</i>	1		INTRO9	<i>INTRO</i>	9	Ending patterns
ROCK'nROLL2	<i>R'nR</i>	2		ENDING1	<i>ENDING</i>	1	
ROCK1	<i>ROCK</i>	1	ENDING2	<i>ENDING</i>	2		
ROCK2	<i>ROCK</i>	2	ENDING3	<i>ENDING</i>	3		
HARDROCK1	<i>HARD</i>	1	ENDING4	<i>ENDING</i>	4		
HARDROCK2	<i>HARD</i>	2	ENDING5	<i>ENDING</i>	5		
METAL1	<i>METAL</i>	1	ENDING6	<i>ENDING</i>	6		
METAL2	<i>METAL</i>	2					
THRASH	<i>THRASH</i>						
PUNK	<i>PUNK</i>						
POP1	<i>POP</i>	1	Dance patterns				
POP2	<i>POP</i>	2					
DANCE1	<i>DANCE</i>	1					
DANCE2	<i>DANCE</i>	2					
DANCE3	<i>DANCE</i>	3					
FUNK1	<i>FUNK</i>	1					
FUNK2	<i>FUNK</i>	2					
BALLAD1	<i>BALLAD</i>	1					
BALLAD2	<i>BALLAD</i>	2					
BLUES1	<i>BLUES</i>	1					
BLUES2	<i>BLUES</i>	2					
COUNTRY	<i>COUNTRY</i>		Other genres				
BOSSANOVA	<i>BOSSA</i>						
JAZZ1	<i>JAZZ</i>	1					
JAZZ2	<i>JAZZ</i>	2					
REGGAE	<i>REGGAE</i>						
SKA	<i>SKA</i>						
LATIN1	<i>LATIN</i>	1					
LATIN2	<i>LATIN</i>	2					

# Changing the Sound of a Patch (Edit Mode)

The edit mode allows you to freely alter the parameters that make up a patch, so that you can create your own patches. This section describes how to edit patches and how to store edited patches.

## Patch Configuration

Each patch of the 708II consists of several effects (effect modules), as shown in the illustration below. A patch is a combination of modules, each with their distinct parameter settings.



Within each module, there are several different but related effects which are called effect types. For example, the MODULATION module comprises effect types such as CHORUS and PHASER.

The elements that determine the sound of a patch are called effect parameters. Each module has several effect parameters, whose value can be adjusted with the parameter knobs 1 – 3, the [DRIVE] knob, [DRIVE VARIATION] key, etc.

### NOTE

Also within the same module, different effect types will have different parameters.

## Basic Edit Mode Steps

This section describes the basic procedure for editing patches. For information on effect types and parameters in the various modules, see p. 33 – 38.

### 1. In play mode, select the patch you want to edit.

Patches for editing can be selected from either the USER group or the PRESET group. However, the PRESET group does not allow storing. When you have altered a patch from the PRESET group and want to store it, "A0" in the USER group is automatically selected as store target.

### 2. Press the [EDIT] key.

The 708II switches to the edit mode. The LED of the module currently selected for editing

flashes. (The first time you switch to edit mode after the unit was turned on, the TOTAL module will be selected.)

### 3. Use the MODULE [◀]/[▶] keys to select the module you want to edit.

Modules are switched in the order shown below, and the respective module LED is flashing.

The display shows the effect type currently selected for that module. If the effect can be controlled with the expression pedal, the indication "Pd" is shown on the [BANK/PATCH] indicator.

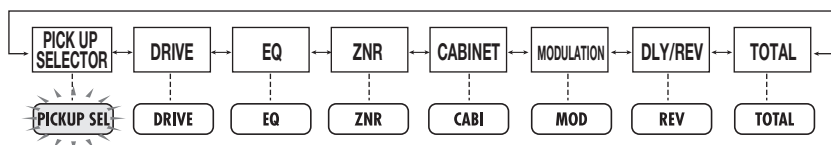

HALL

Effect type

Pd

Shown if selected effect can be controlled by pedal

### NOTE

Some modules and effects have many parameters, so that settings are divided into several pages. When editing such modules (effects), switch between pages with the [EDIT] key.

#### 4. To switch the on/off status of the selected module, press both MODULE [◀]/[▶] keys together.

When you change the module on/off status, effect type selection, or a parameter value, a dot (.) appears at the "EDITED" position of the [BANK/PATCH] indicator. When this dot is shown in edit mode, it means that the currently selected module has been edited. If you return the module to the original setting, the dot disappears.



When a dot (.) is shown here, the currently selected module was edited.

#### 5. To change the effect type of the currently selected module, press one of the TYPE [▼]/[▲] keys.

#### 6. To change a parameter setting, use the parameter knobs 1 – 3.

Parameter knobs 1 – 3 serve for adjusting three parameters of the currently selected module. When you operate a knob, the display shows the parameter name, and the [BANK/PATCH] indicator shows the current setting value.

For example, if the effect type ROOM is selected for the REV module, parameter knobs 1 – 3 control the following parameters.

- Parameter knob 1: TIME
- Parameter knob 2: TONE
- Parameter knob 3: MIX

#### 7. If you want to check the current setting without moving the parameter knob, press the TYPE [▼]/[▲] keys together. With each push of the two keys, the names of parameters 1 – 3 and the respective settings are shown.



First push



Second push

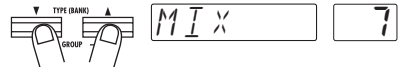

Third push

#### 8. To directly switch the effect type of the DRIVE module, use the [DRIVE] knob and [DRIVE VARIATION] key.

As in play mode, the [DRIVE] knob and [DRIVE VARIATION] key directly control the effect type of the DRIVE module.

#### 9. Repeat steps 3 – 8 to edit other modules.

#### 10. When editing is completed, press the [PLAY] key or the [CANCEL/EXIT] key.

The 708II returns to the play mode. A dot (.) appears at the "EDITED" position of the [BANK/PATCH] indicator if any aspect of the patch has been edited.

### NOTE

If you wish to keep the patch, be sure to perform the store operation. Otherwise all changes will be permanently lost as soon as you switch to another patch. (→ P. 20)

## Storing and Swapping Patches

This section describes how to store an edited patch in memory, and how to swap patches in the USER group.

### 1. In play mode or edit mode, press the [STORE/EXECUTE] key.

The 708II enters the store standby condition. The patch name and the indications "STORE" and "SWAP" are shown alternately on the display. The [BANK/PATCH] indicator shows the bank and patch number.



#### **HINT**

To change the name of an edited patch, see p. 38.

### 2. Use the MODULE [◀]/[▶] keys to select either "STORE" or "SWAP".

#### **NOTE**

If the original patch is from the PRESET group, "SWAP" cannot be selected.

### 3. Use the TYPE [▼]/[▲] keys or the [▼]/[▲] foot switches to select the target patch for storing.

The name of the newly selected patch and the indication "STORE?" are shown alternately on the display. The bank and patch number flash on the [BANK/PATCH] indicator.

#### **NOTE**

The PRESET group cannot be selected as store target. If you press the [STORE/EXECUTE] key while a patch from the PRESET group is selected, the selection automatically changes to "A0" in the USER group.

### 4. To carry out the store or swap operation, press the [STORE/EXECUTE] key once more.

The store or swap operation is performed, and then the unit returns to the original mode. If the patch in step 1 was being edited, the editing changes are stored.

If you press the [CANCEL/EXIT] key instead of the [STORE/EXECUTE] key, the store/swap operation is canceled and the unit returns to the original mode.

# Other Functions

The 708II also incorporates various other convenient functions which are described in this section.

## Using the Hold Delay Function

The DLY/REV module comprises a hold delay effect that allows recording and playing a bass phrase of up to 2 seconds. You can also play the phrase in reverse or perform loop playback to create interesting "sound-on-sound" layers.

**1. In play mode, select the patch to use with hold delay.**

**2. Press the [EDIT] key to activate edit mode, and select "HLDDLY" as effect type for the DLY/REV module.**

**3. Use parameter knob 1 to set the TIME parameter.**

The TIME parameter determines the length of the recording interval for hold delay. Turning the knob changes the value as follows.

- **1 – 99:** 10 – 990 milliseconds (10-ms units)
- **1.0 – 2.0:** 1.0 – 2.0 seconds (100-ms units)
- **Mn (Manual):** Recording starts when you press the [▲] foot switch and ends when you press the [▲] foot switch again (max. 2 seconds).

**4. Use parameter knob 2 to set the MODE parameter.**

The MODE parameter determines how the recorded phrase is played back. The following three modes are available.

- **nL (Normal):** Normal direction playback
- **So (Sound-on-sound):** Recorded contents are played back repeatedly to create an overlay.  
If you press the [▲] foot switch, the phrase played until the switch is pressed again is added to the sound.
- **rS (Reverse):** Reverse direction playback.

**5. Use parameter knob 3 to set the MIX parameter.**

The MIX parameter controls the mixing ratio of the delayed sound. A setting of 30 results in equal levels of direct sound and delayed sound.

**6. Press the [PEDAL] key a few times until the [PEDAL] LED of the REV module flashes.**

The expression pedal can now be used to switch the hold delay function on and off.

**7. Store the patch and return to play mode.**

When a patch in which hold delay can be used is selected in play mode, the DLY/REV module LED and the [PEDAL] LED are flashing.

**8. Push the expression pedal all the way down.**

The hold delay function is switched on and the unit is in recording standby mode. The indication "STOP" is shown on the display.



**9. While playing your bass, press the [▲] foot switch to start recording.**

The indication "REC" is shown on the display. The actual operation depends on the TIME parameter set in step 3.

■ **If a numeric value is set as TIME parameter**

Recording starts at the moment you push the [▲] foot switch and continues for the duration set with the TIME parameter. After recording ends, loop playback starts automatically.

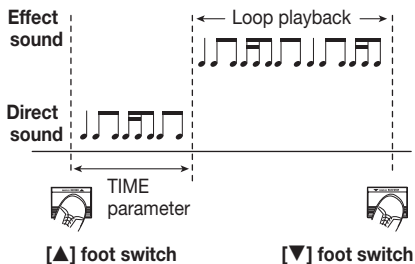

■ **If TIME parameter is set to "Mn"**

Recording starts at the moment you push the [▲] foot switch and continues until you push the switch again, or until 2 seconds have elapsed. After recording ends, loop playback starts automatically.

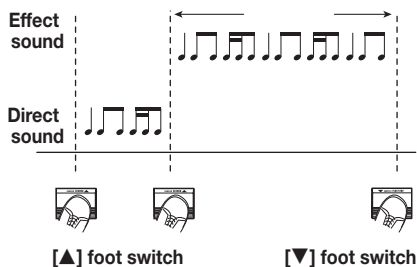

■ **If TIME parameter is set to "Mn" and MODE parameter to "So"**

When the TIME parameter is set to "Mn" and the MODE parameter to "So" (sound-on-sound), pressing the [▲] foot switch adds the currently played phrase until the switch is pressed again.

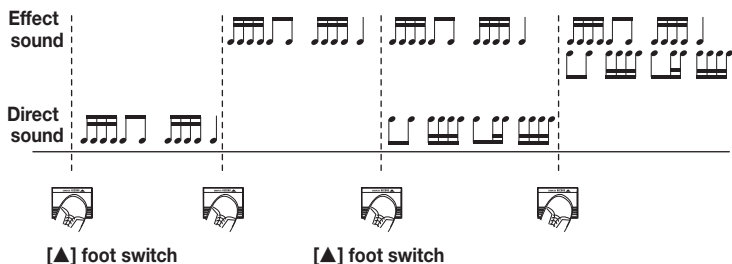

10. To stop playback, press the [▼] foot switch.

11. To turn the hold delay function off, push the expression pedal once more all the way down.

The unit returns to the play mode.

## Changing the Patch Call Method

In the factory default condition, patches are switched as soon as you make the selection, resulting in an immediate change in the sound. If you want to change to a distant patch, all the intermediate patches will briefly change the sound, which may not be desirable, especially during a performance. In such a case, you can change to the preselect method.

When the preselect method is enabled, you first select the desired patch, but the sound does not change until confirmed by you.

1. To change the patch call method to preselect, hold down the [▲] foot switch while turning power to the 708II on.

2. Select the patch in play mode.

When you select a patch in this condition, the display and [BANK/PATCH] indicator show the new patch (flashing), but the sound does not change.



3. To confirm the patch change, press both [▼]/[▲] foot switches together.

The display and [BANK/PATCH] indicator stop flashing, and the unit switches to the new patch, causing the sound to change.

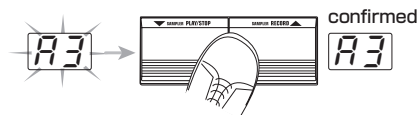

### HINT

To return to the default patch selection method, turn the 708II off and on again.

## Using the Pedal to Control an Effect

You can use the expression pedal of the 708II to control the parameter, on/off status, or volume level of a specific effect. The pedal adjustment range can be memorized individually for a patch.

1. Select a patch in play mode.
2. Use the [PEDAL] key to select the module/effect type to be controlled with the expression pedal.

Each push of the [PEDAL] key cycles through the [PEDAL] LEDs as shown below.

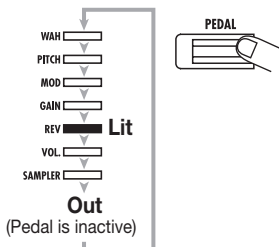

The [PEDAL] LEDs indicate the module/effect type assigned to the pedal. The meaning of the LEDs is explained below.

### • WAH

The expression pedal functions as a pedal wah. The effect type P-WAH (pedal wah) of the MODULATION module is assigned to the pedal, and the FREQ parameter can be adjusted. Even if another effect type is currently selected for the MODULATION module, the effect type is temporarily switched to P-WAH.

### • PITCH

The expression pedal functions as a pitch shifter. The effect type P-PIT (pedal pitch) of the MODULATION module is assigned to the pedal, and pitch can be adjusted. Even if another effect type is currently selected for the

MODULATION module, the effect type is temporarily switched to P-PIT.

- **MOD**

The effect type currently selected for the MODULATION module is adjusted by the pedal. Which parameter is controlled depends on the effect type.

- **GAIN**

The currently selected effect is adjusted by the pedal. Which parameter is controlled depends on the effect type.

- **REV**

The effect type currently selected for the DLY/REV module is adjusted by the pedal. Which parameter is controlled depends on the effect type.

- **VOL**

The master volume is adjusted by the pedal.

- **SAMPLER**

The sampler function is switched on/off by the pedal. Pushing the pedal all the way down toggles between sampler on ([PEDAL] LED lit) and sampler off ([PEDAL] LED flashed).

Also if a module is currently off, selecting it with the [PEDAL] key will cause its [PEDAL] LED to light and the module will temporarily come on. If a patch is stored in this condition, the module will be stored as ON.

The actual parameter that is controlled by the pedal depends on the effect type. For details, see p. 33 – 38.

 **HINT** 

The above procedure for assigning a module/effect type to the expression pedal can be carried out also in edit mode.

3. Press the [EDIT] key to activate the edit mode.
4. Use the MODULE [◀]/[▶] keys to select the TOTAL module.

5. Press the [EDIT] key once more.

The key lights up in green. In this condition, parameter knobs 2 and 3 have the following functions.

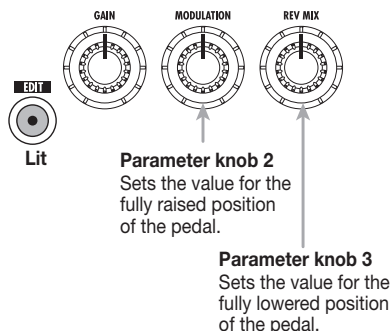

6. Use parameter knobs 2 and 3 to set the PDLMIN value (when pedal is fully raised) and PDLMAX value (when pedal is fully lowered). The setting range for both values is 0 – 10.

When you operate parameter knob 2, the indication "PDLMIN" appears on the display. When you operate parameter knob 3, the indication "PDLMAX" appears on the display. The 0 – 10 value is shown on the [BANK/PATCH] indicator.

Setting PDLMIN or PDLMAX to 0 means that the parameter assigned to the pedal will be at the minimum value. Setting PDLMIN or PDLMAX to 10 means that the parameter assigned to the pedal will be at the maximum value.

When the 708II is in the default condition, PDLMIN is set to 0 and PDLMAX is set to 10. As the pedal is depressed, the parameter value gradually increases from minimum to maximum.

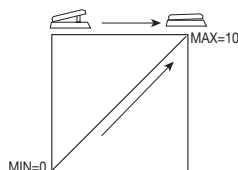



For example, when PDLMIN is set to 4 and PDLMAX to 8, the parameter adjustment range will be limited as shown in the illustration below.

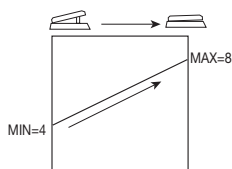

When PDLMIN is set to 7 and PDLMAX to 2, pushing the pedal decreases the parameter value, and the range is as shown below.

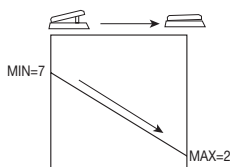

## Adjusting the Expression Pedal

The expression pedal is adjusted for optimum operation at the factory, but sometimes, readjustment may be necessary. If pushing the pedal fully down does not have a strong effect, or if the volume or sound changes excessively even when the pedal is only lightly pushed, adjust the pedal as follows.

1. Turn power to the 708II on while keeping the [PEDAL] key depressed.

The indication "MIN" appears on the display.

2. With the expression pedal fully raised, press the [STORE/EXECUTE] key.

The display indication changes to "MAX".



3. Push the expression pedal fully down and then lift your foot off the pedal.

The pedal goes back a little.

7. Press the [STORE/EXECUTE] key to store the patch.

The module which is assigned to the pedal will automatically be stored as ON.

8. In play mode, move the pedal while playing your bass.

The parameter assigned to the pedal changes.

9. Push the pedal fully down.

The module which is assigned to the pedal is switched between on and off. If the pedal is assigned to the sampler, the sampler function is switched on or off.

### NOTE

If the pedal is assigned to the volume, pushing the pedal fully down does not perform any switching action.

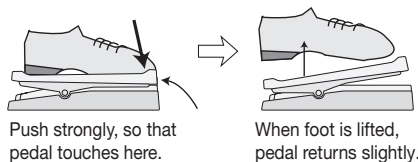

Push strongly, so that pedal touches here.

When foot is lifted, pedal returns slightly.

4. Press the [STORE/EXECUTE] key.

The adjustment is completed, and the unit returns to the play mode.

### HINT

- The position of the pedal in step 3 determines the on/off switching point. If you want the pedal to perform on/off switching with a lighter touch, set the pedal to a somewhat higher position.
- If the indication "ERROR" appears, return to step 2 and repeat the procedure.

## Storing Rhythm Patterns and Samples as Part of a Patch

The patches of the 708II can contain not only information about effect type and parameter settings but also about rhythm patterns and samples stored on a SmartMedia card. Using this capability, you can quickly switch rhythm patterns on the fly, or you can have the same sample play every time you call up a certain patch.

### Assigning a rhythm pattern to a patch

By assigning rhythm patterns to patches, you can have the rhythm change in sync with the patches.

1. In play mode, select the patch to which you want to assign a rhythm pattern, and press the [EDIT] key.
2. Use the MODULE [◀]/[▶] keys to select the TOTAL module.
3. Press the [EDIT] key once more.

The [EDIT] key lights up in green. You can now use parameter knob 1 to select the rhythm pattern to assign to the patch.

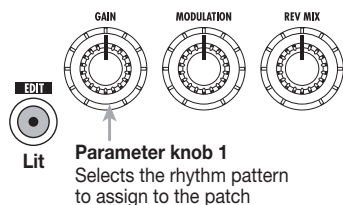

4. Use parameter knob 1 to select the desired rhythm pattern.

The pattern name appears on the display. You can play the pattern by pressing the [▶/■] key.

### **HINT**

Depending on the rhythm pattern type selected here (intro, ending, other), the pattern playback operation when switching patches will differ.

5. Press the [STORE/EXECUTE] key to store the patch.

Assign other rhythm patterns to other patches in the same way.

6. When all patches have been prepared, press the [PATCH SYNC] key so that the LED of the key is lit.

When the [PATCH SYNC] key is set to ON, patches and rhythm patterns are switched in sync.

### **NOTE**

When the [PATCH SYNC] key is set to OFF, the rhythm pattern assignment to the patches has no effect.

7. Call up the patch to which the desired rhythm pattern was assigned.

When the [PATCH SYNC] key is set to ON, the operation when switching patches depends on the type of rhythm pattern that has been assigned.

#### • Intro rhythm pattern (INTRO 1 – 9)

When a patch is switched, rhythm pattern play starts automatically. The pattern continues to play until the [▶/■] key is pressed or until you switch to another patch.

#### • Ending rhythm pattern (ENDING 1 – 6)

After switching a patch, rhythm pattern play begins if you press the [▶/■] key. The pattern automatically stops at the end of the pattern.

#### • Other rhythm pattern

After switching a patch, rhythm pattern play begins if you press the [▶/■] key. The pattern continues to play until the [▶/■] key is pressed again or until you switch to another patch.

## 8. Press the [▶/■] key.

The rhythm pattern of the patch selected in step 7 starts to play. (If an intro type pattern has been assigned, playback starts when the patch is switched in step 7.)

## 9. If necessary, use parameter knobs 2 and 3 to adjust the tempo and volume of the pattern.

Also when the [PATCH SYNC] key is ON, parameter knobs 2 and 3 can be used to adjust the tempo and volume for all patterns. (If desired, you can also use parameter knob 1 to switch to manual operation of the pattern.)

## 10. Switch the patch.

When you switch the patch while a rhythm pattern is playing, the pattern continues to play until the end of the current measure and then switches to the pattern that is assigned to the new patch.

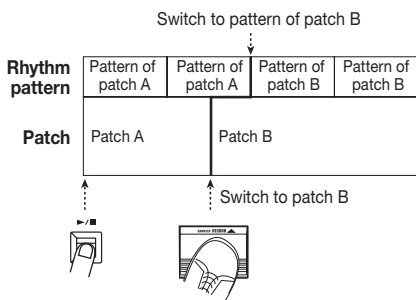

Switch to other patches in the same way.

## 11. To stop rhythm pattern playback, press the [▶/■] key.

If an ending pattern is assigned to a patch, the pattern will play when switching to the patch, and then stop.

## 12. Press the [PATCH SYNC] key so that the LED of the key is out.

## Assigning a sample to a patch

By assigning a sample stored on SmartMedia card to a patch, you can have the sample play every time you select the patch.

1. Insert the SmartMedia card into the 708II and sample the phrase or source material that you want to use.
2. In play mode, select the patch to which you want to assign a sample, and press the [EDIT] key.
3. Use the MODULE [◀]/[▶] keys to select the TOTAL module.

The "PATLVL" (patch level) parameter appears on the display.

## 4. Press the [EDIT] key twice.

The [EDIT] key lights up in orange. You can now use parameter knobs 1 – 3 to control the following functions.

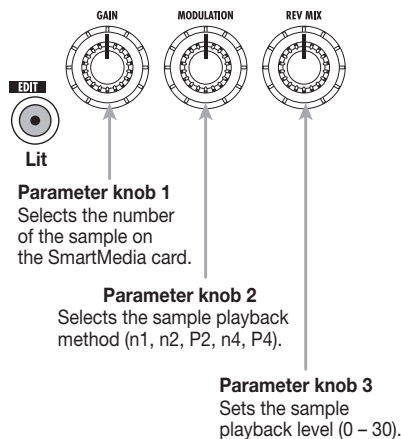

## HINT

For details regarding playback mode, see p. 14.

5. Use parameter knobs 1 – 3 to select the sample number, playback method, and playback level.

If you want to check out the sample, press the [SAMPLER] key to activate the sampler mode, and press the [▼] foot switch to play the currently selected sample.

**6. Press the [STORE/EXECUTE] key to store the patch.**

Assign other samples to other patches in the same way.

**7. When all patches have been prepared, select a patch in play mode to which a sample was assigned.**

**8. Press the [SAMPLER] key to activate the sampler mode.**

For a patch where the expression pedal is assigned to SAMPLER, you can also push the expression pedal fully down to set the sampler function to ON.

**9. Press the [▼] foot switch.**

The sample assigned to the patch is played.

**10. Use the MODULE [◀]/[▶] keys, and [▼] foot switches to control play/stop/rewind/fast-forward.**

**11. Press the [SAMPLER] key to turn the sampler mode off.**

## Using SmartMedia card (Utility Mode)

A SmartMedia card inserted in the 708II can hold up to five groups of patches and 60 samples. This section describes the utility mode that provides various SmartMedia card related functions.

### Basic utility mode operation steps

The steps for various utility mode functions are similar, as described below.

**1. Verify that a SmartMedia card is inserted in the card slot.**

When a SmartMedia card is inserted, the [SMART MEDIA] LED is lit. (For information on how to insert a SmartMedia card, see p. 6.)

**2. In play mode, press the [UTILITY] key.**

The 708II enters the utility mode. The indication "LOAD" appears on the display.

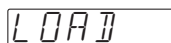

**3. Use the TYPE [▼]/[▲] keys to call up the desired function.**

The utility mode comprises the following functions.

- **LOAD (Load patch)**  
Loads a single patch stored on a SmartMedia card into the memory of the unit (USER group).
- **SAVE (Save patch)**  
Stores a single patch from the memory of the unit (USER group) on a SmartMedia card.
- **ALLOAD (Load patch group)**  
Loads an entire patch group stored on a SmartMedia card into the memory of the unit (USER group).
- **ALSAVE (Save patch group)**  
Stores all patches of the USER group from the memory of the unit on a SmartMedia card.
- **P DEL (Delete patch group)**  
Deletes a patch group stored on a SmartMedia card.
- **SP DEL (Delete sample)**  
Deletes a sample stored on a SmartMedia card.
- **FORMAT**  
Formats a SmartMedia card card.

#### 4. Press the [STORE/EXECUTE] key.

The setting screen for the function selected in step 3 appears.

The subsequent steps depend on the selected function. For details, see the respective sections.

### Utility mode functions

#### Storing a single patch on a SmartMedia card

You can store a single patch from the internal memory of the 708II on a SmartMedia card.

##### 1. In play mode, select the patch from internal memory that you want to store.

A patch that is currently being edited cannot be stored on the SmartMedia card. You must store the patch in internal memory first.

##### 2. Activate utility mode and select "SAVE". Then press the [STORE/EXECUTE] key.

The indication "GROUP" appears on the display, and the [BANK/PATCH] indicator shows the group number (1 – 5) for storing. If a "\*" is shown after "GROUP", there are patches stored in that group.

##### 3. Use the TYPE [▼]/[▲] keys to select the patch group (1 – 5) for storing, and then press the [STORE/EXECUTE] key.

One SmartMedia card can hold up to five patch groups (with 60 patches per group). Pressing the [STORE/EXECUTE] key confirms the store target group. The indication "SAVE" appears on the display, and the [BANK/PATCH] indicator shows the store target bank (A – F) and patch number (0 – 9).

##### 4. Use the TYPE [▼]/[▲] keys and [▼]/[▲] foot switches to select the desired bank (A – F) and patch number (0 – 9) in the patch group.

#### 5. Press the [STORE/EXECUTE] key.

The indication "SURE?" appears on the display.

#### 6. To carry out the operation, press the [STORE/EXECUTE] key once more.

The single patch is stored on the SmartMedia card. When the process is completed, the unit reverts to play mode.

If you press the [CANCEL/EXIT] key instead of the [STORE/EXECUTE] key, the store operation is canceled.

#### NOTE

- Any patch that is present in the target location on the SmartMedia card will be overwritten. Take care not to accidentally overwrite a patch that you want to keep.
- Never insert or remove the SmartMedia card while power to the unit is turned on. Otherwise all data on the card may be lost.
- If the target group is empty, all patches of the USER group are stored.

#### Loading a single patch from a SmartMedia card

You can load a single patch from a SmartMedia card into the internal memory of the 708II.

##### 1. In play mode, select the patch in internal memory into which you want to load the patch.

##### 2. Activate utility mode and select "LOAD". Then press the [STORE/EXECUTE] key.

The indication "GROUP" appears on the display, and the [BANK/PATCH] indicator shows the group number (1 – 5) from which to load.

##### 3. Use the TYPE [▼]/[▲] keys to select the patch group (1 – 5) on the SmartMedia card from which to load, and then press the [STORE/EXECUTE] key.

The indication "LOAD" appears on the display,

---

and the [BANK/PATCH] indicator shows the load source bank (A – F) and patch number (0 – 9).

**4. Press the [STORE/EXECUTE] key.**

The indication "SURE?" appears on the display.

**5. To carry out the operation, press the [STORE/EXECUTE] key once more.**

The single patch is loaded from the SmartMedia card into the memory of the unit. When the process is completed, the unit reverts to play mode.

If you press the [CANCEL/EXIT] key instead of the [STORE/EXECUTE] key, the load operation is canceled.

**NOTE**

- Any patch that is present in the target location will be overwritten. Take care not to accidentally overwrite a patch that you want to keep.
- Never insert or remove the SmartMedia card while power to the unit is turned on. Otherwise all data on the card may be lost.

## Storing a group on a SmartMedia card

You can store the USER group of the 708II on a SmartMedia card as a patch group.

**1. In utility mode, select "ALSAVE" and press the [STORE/EXECUTE] key.**

The indication "GROUP" appears on the display, and the [BANK/PATCH] indicator shows the group number (1 – 5) for storing.

**2. Use the TYPE [▼]/[▲] keys to select the patch group (1 – 5) for storing, and then press the [STORE/EXECUTE] key.**

The indication "SURE?" appears on the display.

**3. To carry out the operation, press the [STORE/EXECUTE] key once more.**

The entire USER group of the 708II is stored on the SmartMedia card. When the process is completed, the unit reverts to play mode.

If you press the [CANCEL/EXIT] key instead of the [STORE/EXECUTE] key, the store operation is canceled.

**NOTE**

Any patch group that was stored on the SmartMedia card in that position will be overwritten. Be careful not to overwrite a group that you wish to keep.

## Loading a group from a SmartMedia card

You can load a patch group stored on a SmartMedia card into the memory of the unit.

**1. In utility mode, select "ALLOAD" and press the [STORE/EXECUTE] key.**

The indication "GROUP" appears on the display, and the [BANK/PATCH] indicator shows the group number (1 – 5) for loading.

**2. Use the TYPE [▼]/[▲] keys to select the patch group (1 – 5) for loading, and then press the [STORE/EXECUTE] key.**

The indication "SURE?" appears on the display.

**3. To carry out the operation, press the [STORE/EXECUTE] key once more.**

The entire selected patch group is loaded from the SmartMedia card into the USER group of the 708II. When the process is completed, the unit reverts to play mode.

If you press the [CANCEL/EXIT] key instead of the [STORE/EXECUTE] key, the load operation is canceled.

**NOTE**

All patches currently stored in the USER group of the unit will be overwritten. Take care not to accidentally overwrite patches that you want to keep.

## Deleting a group from a SmartMedia card

You can delete any group stored on a SmartMedia card.

1. In utility mode, select "P DEL" and press the [STORE/EXECUTE] key.

The display shows "GROUP" and the [BANK/PATCH] indicator shows the group number (1 – 5) for deleting.

2. Use the TYPE [▼]/[▲] keys to select the patch group (1 – 5) for deleting.

3. Press the [STORE/EXECUTE] key.

The indication "SURE?" appears on the display.

4. To carry out the operation, press the [STORE/EXECUTE] key once more.

The entire selected patch group is deleted from the SmartMedia card. When the process is completed, the unit reverts to play mode.

If you press the [CANCEL/EXIT] key instead of the [STORE/EXECUTE] key, the delete operation is canceled.

### NOTE

A deleted group cannot be restored. Take care not to accidentally delete a group that you want to keep.

## Deleting a sample from a SmartMedia card

You can delete any sample that was stored on a SmartMedia card while using the sampler function.

### NOTE

No special steps must be performed by the user for storing samples on a SmartMedia card. Samples are stored automatically when the SmartMedia card is inserted and the sampler function is used.

1. In utility mode, select "SP DEL" and press the [STORE/EXECUTE] key.

The indication "SP NO" appears on the display, and the [BANK/PATCH] indicator shows the sample number (1 – 60) for deleting.

2. Use the TYPE [▼]/[▲] keys to select the sample to erase from the SmartMedia card.

3. Press the [STORE/EXECUTE] key.

The indication "SURE?" appears on the display.

4. To carry out the operation, press the [STORE/EXECUTE] key once more.

The selected sample is deleted from the SmartMedia card. When the process is completed, the unit reverts to play mode.

If you press the [CANCEL/EXIT] key instead of the [STORE/EXECUTE] key, the delete operation is canceled.

### NOTE

A deleted sample cannot be restored. Take care not to accidentally delete a sample that you want to keep.

## Formatting a SmartMedia card

"Formatting" is the process of preparing a medium such as SmartMedia card for reading and writing data. Before an off-the-shelf SmartMedia card can be used in the 708II, it must first be formatted in the unit.

1. In utility mode, select "FORMAT" and press the [STORE/EXECUTE] key.

The indication "EXEC?" appears on the display.

2. Press the [STORE/EXECUTE] key once more.

The indication "SURE?" appears on the display.

---

### 3. To carry out the operation, press the [STORE/EXECUTE] key once more.

The formatting process starts. When the process is completed, the unit reverts to play mode.

If you press the [CANCEL/EXIT] key instead of the [STORE/EXECUTE] key, the formatting operation is canceled.

#### **NOTE**

Formatting erases all data that may be present on the SmartMedia card. Take care not to accidentally format a card which already contains data that you want to keep.

### SmartMedia card error messages

While using a SmartMedia card, one of the following error indications may appear. The meaning is explained below.

- **[SMART MEDIA] LED does not light**
  - A SmartMedia card with a capacity of less than 8 MB may have been inserted.
  - The SmartMedia card may not have been inserted fully.

- **ERROR**
  - The card was removed or inserted (during sampler operation).
  - The card was removed (in utility mode).
- **WP ERR**

A write protect seal is attached to the SmartMedia card. This prevents writing to the card.
- **FULL**

There is not enough free capacity on the SmartMedia card.
- **NODATA**
  - There are no sampler data (during sampler operation).
  - There are no patch data or sampler data (in utility mode).
- **NO USR**

Loading cannot be performed, because the load target is not the USER group (in utility mode).
- **NO CARD**

SmartMedia card is not inserted.
- **CD ERR**

The card is defective, not inserted correctly, or not properly formatted. The patches in the USER group can be returned to the original condition at any time, even if you have changed them.

## All Initialize/Factory Recall

The All Initialize function returns all patches in the USER group to the default condition. Factory Recall can be used to reset only specific patches in the USER group to the default settings.

### 1. Turn power to the 708II on while pressing the [STORE/EXECUTE] key.

The indication "ALINIT" appears on the display.

- To perform All Initialize, proceed to step 2.
- To perform Factory Recall, use the TYPE [▼]/[▲] keys and [▼]/[▲] foot switches to select the patch that you want to return to the factory default condition.



### 2. Press the [STORE/EXECUTE] key once more.

All Initialize or Factory Recall is carried out. If All Initialize was carried out, the unit automatically returns to the play mode.

The contents of patches stored by the user will be lost when the defaults are restored. To cancel All Initialize/Factory Recall, press the [CANCEL/EXIT] key before step 2.



# Effect Types and Parameters

In this section, all effect types and parameters of the modules in the 708II are explained. (Parameters with the same name and function that are used in several effects are explained only the first time.) The  symbol indicates a parameter that is assigned to the expression pedal and can be changed by moving the pedal (→ p. 23). The symbols  –  indicate the parameters that can be controlled by parameter knobs 1 – 3 in play mode.

## PICKUP SELECTOR Module

This module adjusts the input sensitivity for optimum matching with the type of pickup used by the electric bass. This module has only one effect.

### TYPE 1 PICKUP SELECTOR

**Parameter 1** PICKUP PS, AC

Adjusts the input sensitivity. For passive pickups, select

"PS". For active pickups and pickups with very high output, select "AC".

## DRIVE Module

This module comprises 33 types of amp modeling and bass guitar effects. The [DRIVE] knob allows choosing the amplifier or compact effect type, and the [DRIVE VARIATION] key allows choosing the tone or distortion variation.

### TYPE 1 FAT AMP

**CLASSIC** FDR BS

Vintage sound of a built-in tube amp.

**STANDARD** APG 15

Clean sound of a "flip-top" tube amp.

**MODERN** BG BS

Clean sound of a tube amp with class A/B power stage.

### TYPE 2 BRIGHT AMP

**CLASSIC** TE

High output British stack amp sound.

**STANDARD** SW

Bass amp sound with groove feeling for slap and tapping style playing.

**MODERN** HRTK

Sound of bass amp with aluminum cone speaker.

### TYPE 3 ROCK AMP

**CLASSIC** MS DRV

Bass amp sound for British rock.

**STANDARD** APG SV

Immensely popular tube stack amp sound.

**MODERN** AC DRV

Fuzz style drive amp sound.

\* Parameters for TYPE 1 - 3 are the same.

**Parameter 1** GAIN   1 - 30

Adjusts signal input gain.

**Parameter 2** TONE 0 - 10

Adjusts tone.

**Parameter 3** LEVEL 1 - 8

Adjusts signal level after passing module.

### TYPE 4 COMP/LIMIT (Compressor/Limiter)



**CLASSIC** LR-CMP

Compressor with little tone variation.

**STANDARD** COMP

Universal type compressor that suppresses level peaks for uniformity.

\* Parameters for LR-CMP and COMP are the same.

**Parameter 1** SENS   1 - 30

Adjusts compressor sensitivity.

**Parameter 2** TONE 0 - 10

**Parameter 3** LEVEL 1 - 8

**MODERN** LIMIT

Peak-suppressing limiter.

**Parameter 1** THRESH   1 - 30

Adjusts reference level for limiter operation.

**Parameter 2** TONE 0 - 10

**Parameter 3** LEVEL 1 - 8

### TYPE 5 EQ (Equalizer)

**CLASSIC** SPLIT

This equalizer effect divides the signal into two bands (high/low) and allows free adjustment of mixing balance.

**Parameter 1** HL-BAL   0 - 30

Adjusts mixing balance between high and low band.

**Parameter 2** FREQ 1 - 10

Adjusts crossover frequency between high and low frequency bands.

**Parameter 3** LEVEL 1 - 8

**STANDARD** 8EQ

This is an 8-band equalizer. There are three pages with parameters. Use the [EDIT] key to switch between pages.

#### ■PAGE 1

**Parameter 1** 50Hz  -12 - 0 - 12

<b>Parameter 2</b>	125Hz	-12 - 0 - 12
<b>Parameter 3</b>	250Hz	-12 - 0 - 12
<b>■PAGE 2</b>		
<b>Parameter 1</b>	500Hz	-12 - 0 - 12
<b>Parameter 2</b>	1000Hz	-12 - 0 - 12
<b>Parameter 3</b>	2000Hz	-12 - 0 - 12

**■PAGE 3**

<b>Parameter 1</b>	4000Hz	-12 - 0 - 12
<b>Parameter 2</b>	8000Hz	-12 - 0 - 12
Adjusts boost/cut in respective frequency range.		
<b>Parameter 3</b>	LEVEL	 1 - 8

**MODERN ISOLTR**

This equalizer effect divides the signal into three bands (high/mid/low) and allows free adjustment of mixing balance. There are two pages with parameters. Use the [EDIT] key to switch between pages.

**■PAGE 1**

<b>Parameter 1</b>	HIGH	0F, -12 - 0 - 12
<b>Parameter 2</b>	MID	 0F, -12 - 0 - 12
<b>Parameter 3</b>	LOW	0F, -12 - 0 - 12

Adjusts boost/cut in respective frequency range.

**■PAGE 2**

<b>Parameter 1</b>	FREQ L	5 - 8.0, 0.0 (5=50Hz, 8.0=8kHz, 0.0=10kHz)
--------------------	--------	---

Adjusts crossover frequency between low and mid frequency bands.

<b>Parameter 2</b>	FREQ H	5 - 8.0, 0.0
--------------------	--------	--------------

Adjusts crossover frequency between mid and high frequency bands.

<b>Parameter 3</b>	LEVEL	1 - 8
--------------------	-------	-------

**TYPE 6 ENHANCE (Enhancer)****CLASSIC LO-ENH****STANDARD BP-ENH****MODERN HI-ENH**

This enhancer stresses a particular frequency range. The range is different for the several variations.

\* Parameters for TYPE 6 variations are the same.

<b>Parameter 1</b>	MIX	 0 - 30
--------------------	-----	--

Adjusts enhancer intensity.

<b>Parameter 2</b>	FREQ	1 - 10
--------------------	------	--------

Adjusts frequency to be enhanced.

<b>Parameter 3</b>	LEVEL	1 - 8
--------------------	-------	-------

**TYPE 7 CLEAN****CLASSIC FATCLN**

This effect is a combination of compressor and enhancer, tuned to achieve a fat lower midrange sound.

**STANDARD FITCLN**

This effect is a combination of compressor and enhancer.

\* Parameters for FATCLN and FLTCLN variations are the same.

<b>Parameter 1</b>	COMP	0F, 1 - 30
--------------------	------	------------

Adjusts compressor sensitivity.

<b>Parameter 2</b>	ENHANC	 0F, 1 - 10
--------------------	--------	--

Adjusts enhancer intensity.

<b>Parameter 3</b>	LEVEL	1 - 8
--------------------	-------	-------

**MODERN SHPCLN**

This effect is a combination of limiter and enhancer, tuned to achieve a lean midrange sound.

<b>Parameter 1</b>	LIMIT	0F, 1 - 30
--------------------	-------	------------

Adjusts limiter sensitivity.

<b>Parameter 2</b>	ENHANC	 0F, 1 - 10
--------------------	--------	--

<b>Parameter 3</b>	LEVEL	1 - 8
--------------------	-------	-------

**TYPE 8 OVERDRIVE****CLASSIC BOOST**

Standard booster sound.

**STANDARD OD**

Standard overdrive sound.

**MODERN SP OD**

Modern overdrive sound.

**TYPE 9 DIST/FUZZ (Distortion/Fuzz)****CLASSIC FUZZ**

Fuzz sound with strong distortion.

**STANDARD DIST**

Standard distortion sound.

**MODERN THRASH**

Overdrive sound suitable for heavy metal.

\* Parameters for TYPE 8 and 9 variations are the same.

<b>Parameter 1</b>	GAIN	 1 - 30
--------------------	------	--

<b>Parameter 2</b>	BAL	0 - 10
--------------------	-----	--------

Adjusts mixing balance of direct sound and effect sound.

<b>Parameter 3</b>	LEVEL	1 - 8
--------------------	-------	-------

**TYPE 10 OCTAVE (Octaver)****CLASSIC OCTFUZ**

Combination of octaver and fuzz sound.

<b>Parameter 1</b>	GAIN	1 - 30
--------------------	------	--------

<b>Parameter 2</b>	OCTMIX	 0 - 30
--------------------	--------	--

Adjusts mixing balance of direct sound and 1-octave lower sound.

<b>Parameter 3</b>	LEVEL	1 - 8
--------------------	-------	-------

**STANDARD CMPOCT**

Combination of compressor and octaver.

<b>Parameter 1</b>	COMP	0F, 1 - 30
--------------------	------	------------

Adjusts compressor sensitivity.

<b>Parameter 2</b>	OCTMIX	 0 - 30
--------------------	--------	--

<b>Parameter 3</b>	LEVEL	1 - 8
--------------------	-------	-------

**MODERN OCTENH**

Combination of enhancer and octaver.

<b>Parameter 1</b>	ENHANC	0F, 1 - 10
--------------------	--------	------------

<b>Parameter 2</b>	OCTMIX	 0 - 30
--------------------	--------	--

<b>Parameter 3</b>	LEVEL	1 - 8
--------------------	-------	-------

**TYPE 11 BASS SYNTH (Bass Synthesizer)****CLASSIC V-SYN**

Vintage bass sound effect. There are two pages with parameters. Use the [EDIT] key to switch between pages.

**■PAGE 1**

<b>Parameter 1</b>	DECAY	 1 - 30
--------------------	-------	--

Adjusts tone variation speed.

**Parameter 2** RESO 0 - 10  
Adjusts special sound character resonance depth.

**Parameter 3** BAL  0 - 30  
Adjusts mixing balance of direct sound and synthesizer sound.

#### ■PAGE 2

**Parameter 1** SENS 1 - 16  
Adjusts trigger detection sensitivity.

**Parameter 2** TONE 0 - 10

**Parameter 3** LEVEL 1 - 8

#### STANDARD STDSYN

ZOOM standard bass synthesizer sound. There are two pages with parameters. Use the [EDIT] key to switch between pages.

#### ■PAGE 1

**Parameter 1** VARI 1 - 4  
Selects synthesizer variation.

**Parameter 2** SENS  1 - 16

**Parameter 3** BAL  0 - 30

#### ■PAGE 2

**Parameter 1** EQ HI -12 - 0 - 12  
Adjusts boost/cut in high frequency range.

**Parameter 2** EQ LOW -12 - 0 - 12  
Adjusts boost/cut in low frequency range.

**Parameter 3** LEVEL 1 - 8

#### MODERN SYNTLK

This effect simulates a talking modulator emphasizing vowels. There are two pages with parameters. Use the [EDIT] key to switch between pages.

#### ■PAGE 1

**Parameter 1** VARI IA, UE, UA, oA  
Selects vowel variation.

**Parameter 2** DECAY  1 - 30

**Parameter 3** BAL  0 - 30

#### ■PAGE 2

**Parameter 1** EQ HI -12 - 0 - 12

**Parameter 2** EQ LOW -12 - 0 - 12

**Parameter 3** LEVEL 1 - 8



**NOTE** When the BASS SYNTH effect is selected, the EQ, ZNR, and CABINET modules cannot be used. (They are automatically set to OFF.)

## EQ (Equalizer) Module

This is a 4-band equalizer. There is only one effect, with two pages of parameters. Use the [EDIT] key to switch between pages.

#### ■ PAGE 1

**Parameter 1** HIGH -12 - 0 - 12

**Parameter 2** HI-MID -12 - 0 - 12

**Parameter 3** LO-MID -12 - 0 - 12

#### ■ PAGE 2

**Parameter 1** LOW -12 - 0 - 12

Adjusts boost/cut in respective frequency range.

**Parameter 2** LEVEL 1 - 8

## ZNR/D GATE (ZOOM Noise Reduction/D Gate) Module

This module serves for cutting noise during play pauses. It offers a choice of noise reduction that lowers only noise and a noise gate that cuts the sound off completely when there is no instrument signal.

#### TYPE 1 ZNR (ZOOM Noise Reduction)

The original noise reduction developed by ZOOM cuts noise during performance pauses without impairing sound quality.

#### TYPE 2 D GATE

Vintage type noise gate with distinctive closure characteristics.  
\* Parameters for TYPE 1 and 2 variations are the same.

**Parameter 1** 1 - 8  
Adjusts sensitivity. Set the value for maximum noise reduction without producing an unnatural cut of the instrument sound.

## CABINET Module

Simulates the sound of a speaker cabinet.

#### TYPE 1 BOX

Simulates a small amp cabinet.

#### TYPE 2 CMB (Combo)

Simulates a conventional combo amp cabinet.

#### TYPE 3 BR CMB (Bright Combo)

Simulates a bright combo amp cabinet.

#### TYPE 4 STK (Stack)

Simulates a stack amp cabinet.  
\* Parameters for TYPE 1 - 4 are the same.

**Parameter 1** DEPTH 0 - 10  
Adjusts the intensity of the cabinet effect.

## MODULATION Module

This module contains modulation type effects such as chorus and flanger, effects that drastically change the sound such as a ring modulator, and pitch altering effects such as pitch shift and vibrato.

### TYPE 1 CHORUS

Adds vibration and spaciousness to the sound.

### TYPE 2 V-CHO (Vintage Chorus)

Simulates the warm sound of a vintage effect.

\* Parameters for TYPE 1 and 2 variations are the same.

**Parameter 1** DEPTH 0 - 10

Adjusts modulation intensity.

**Parameter 2** RATE  (V-CHO) 1 - 30

Adjusts modulation speed.

**Parameter 3** MIX   (CHORUS) 0 - 30

Adjusts mixing balance of direct sound and effect sound.

### TYPE 3 FLANGE (Flanger)

Produces a unique, undulating sound.

**Parameter 1** DEPTH 0 - 10

**Parameter 2** RATE   1 - 30

**Parameter 3** FB -10 - 0 - 10

Adjusts feedback ratio. Higher values in positive or negative direction result in stronger characteristics.

### TYPE 4 PHASE (Phaser)

Produces a swooshing sound.

**Parameter 1** POSI AF, bF

Selects connection point of MOD module. (AF: after CABINET module; bF: before DRIVE module)

**Parameter 2** RATE  1 - 30

**Parameter 3** COLOR  1 - 4

Selects sound character.

### TYPE 5 TREMOL (Tremolo)

Periodically varies the level of the sound.

**Parameter 1** DEPTH 0 - 10

**Parameter 2** RATE   1 - 30

**Parameter 3** CLIP 0 - 10

Adjusts modulation waveform clip. Larger values result in more intense modulation.

### TYPE 6 A-PAN (Auto-Pan)

This stereo panning effect periodically moves the sound back and forth between right and left when two amplifiers are used. When one amplifier is used, the effect is a tremolo effect.

**Parameter 1** WIDTH 0 - 10

Adjusts effect width.

**Parameter 2** RATE   1 - 30

**Parameter 3** CLIP 0 - 10

### TYPE 7 A-WAH (Auto Wah)

This effect gives an automatically varying wah sound that depends on the picking intensity.

**Parameter 1** POSI AF, Ar, bF, br

Selects connection sequence of DRIVE module and MOD module, and the wah sound character.

- AF: DRIVE →MOD module. Fat wah.
- Ar: DRIVE →MOD module. Pronounced wah.
- bF: MOD →DRIVE module. Fat wah.
- br: MOD →DRIVE module. Pronounced wah.

**Parameter 2** SENS  -10 -- -1, 1 - 10

Adjusts wah sensitivity. Negative values result in downward wah.

**Parameter 3** DIRMIX  0 - 10

Adjusts mixing balance of direct sound and effect sound.

### TYPE 8 P-WAH (Pedal Wah)

This effect lets you control wah with the expression pedal.

**Parameter 1** POSI AF, Ar, bF, br

Selects connection sequence of DRIVE module and MOD module, and the wah sound character. (For details, see TYPE 7 A-WAH.)

**Parameter 2** FREQ  1 - 10

Adjusts wah effect center frequency.

**Parameter 3** DIRMIX  0 - 10

### TYPE 9 STEP

This is a special effect with step-like filter characteristics.

**Parameter 1** DEPTH 0 - 10

**Parameter 2** RATE   1 - 30

**Parameter 3** RESO 0 - 10

Adjusts wah effect intensity.

### TYPE 10 PITCH (Pitch Shifter)

This is a pitch shifter with a range of 2 octave up and 1 octaves down.

**Parameter 1** SHIFT  -12 - 1, dt, 1 - 12, 24

Sets the pitch shift amount. The "dt" setting results in a detune effect.

**Parameter 2** TONE 0 - 10

**Parameter 3** BAL  0 - 30

### TYPE 11 P-PIT (Pedal Pitch)

This effect lets you vary the pitch in real time, using the expression pedal.

**Parameter 1** TYPE  1 - 16

Selects the pedal pitch type. Depending on the type, the pitch differs when pushing the pedal down or when raising it.

P-PIT TYPE	Pedal	
	minimum value	maximum value
1	-100 cent	Original sound only
2	Original sound only	-100 cent
3	DOUBLING Detune + DRY	Detune + DRY DOUBLING
4	0 cent	+1 octave
5	+1 octave	0 cent
6	0 cent	-1 octave
7	-1 octave	0 cent
8	-1 octave + DRY	+1 octave + DRY
9	+1 octave + DRY	-1 octave + DRY
10	-700 cent + DRY	500 cent + DRY
11	500 cent + DRY	-700 cent + DRY
12	-∞ (0 Hz) + DRY	+1 octave
13	+1 octave	-∞ (0 Hz) + DRY
14	-∞ (0 Hz) + DRY	+1 octave + DRY
15	+1 octave + DRY	-∞ (0 Hz) + DRY
16	-∞ (0 Hz) + DRY	+1 octave + DRY

**Parameter 2** TONE 0 - 10

### TYPE 12 RING-M (Ring Modulator)

Produces a metallic sound.

**Parameter 1** POSI AF, bF  
Selects connection point of MOD module. (AF: after CABINET module; bF: before DRIVE module)

**Parameter 2** RATE 1 - 30

Sets frequency for ring modulation effect.  
The tone changes depending on the frequency setting.

**Parameter 3** BAL 0 - 30

### TYPE 13 SLOW-A (Slow Attack)

This effect produces a gradual attack sound.

**Parameter 1** POSI AF, bF  
Selects connection point of MOD module. (AF: after CABINET module; bF: before DRIVE module)

**Parameter 2** TIME 1 - 30

Adjusts attack speed.

**Parameter 3** CURVE 1 - 10

Adjusts attack curve.

### TYPE 14 DEFRET

This effect simulates the sound of a fretless bass. The effect should be used only when playing single notes.

**Parameter 1** SENS 1 - 16  
Adjusts trigger sensitivity.

**Parameter 2** ATTACK 1 - 10  
Adjusts attack speed.

**Parameter 3** SINK 1 - 10  
Adjusts sound variation range for picking.

### TYPE 15 DELAY

Delay effect with a delay time of up to 500 milliseconds.

### TYPE 16 ECHO

Delay effect with soft tape echo sound.

\* Parameters for TYPE 15 and 16 variations are the same.

**Parameter 1** TIME (ECHO) 1 - 50

Adjusts delay time.

**Parameter 2** FB 0 - 10

Adjusts number of repeat cycles (feedback) for delay sound.

**Parameter 3** MIX (DELAY) 0 - 30

Adjusts effect sound level.

### TYPE 17 T-TRIP (Time Trip)

This delay effect varies the delay time according to the picking intensity.

**Parameter 1** SENS 1 - 50

Adjusts effect sensitivity.

**Parameter 2** FB -10 - 0 - 10

**Parameter 3** BAL 0 - 30

### TYPE 18 TRMCHO (Tremolo + Chorus)

This is a combined tremolo and chorus effect.

**Parameter 1** TRMRAT 1 - 30

Adjusts tremolo speed.

**Parameter 2** CHORAT 1 - 30

Adjusts modulation speed of chorus effect.

**Parameter 3** CHOMIX 0 - 30

Adjusts chorus sound level.

### TYPE 19 RINVIB (Ring Modulator + Vibrato)

This is a combined ring modulator and vibrato effect.

**Parameter 1** RINRAT 1 - 30

Adjusts ring modulation effect frequency.

**Parameter 2** VIBRAT 1 - 30

Adjusts vibrato effect speed.

**Parameter 3** VIBDEP 0 - 10

Adjusts vibrato effect depth.

### TYPE 20 VIBE (Vibrato)

This is an automatic vibrato effect.

**Parameter 1** DEPTH 0 - 10

**Parameter 2** RATE 1 - 30

**Parameter 3** BAL 0 - 30

## DLY/REV (Delay/Reverb) Module

This module comprises various spatial effects including delay and reverb.

### TYPE 1 HALL (Hall Reverb)

This is a reverb effect which simulates the acoustics of a concert hall.

### TYPE 2 ROOM (Room Reverb)

This is a reverb effect which simulates the acoustics of a room.

**TYPE 3 SPRING (Spring Reverb)**

This is a reverb effect which simulates a spring type reverb machine.

\* Parameters for TYPE 1 - 3 are the same.

**Parameter 1** TIME 1 - 30

Adjusts reverb duration (reverb time).

**Parameter 2** TONE 0 - 10

Adjusts effect tone.

**Parameter 3** MIX  0 - 30

Adjusts reverb sound mix.

**TYPE 4 MN-DLY (Mono delay)**

This is a monaural delay with a duration of up to 1.5 seconds.

**TYPE 5 PP-DLY (Ping-Pong Delay)**

When two amplifiers are used, this serves as a ping-pong delay effect with a duration of up to 1.5 seconds. When one amplifier is used, the effect is a mono delay.

\* Parameters for TYPE 4 and 5 are the same.

**Parameter 1** TIME 1 - 99, 1.0 - 1.5

Adjusts delay time from 10 ms to 990 ms in 10-ms steps (1 - 99), and over 1 second in 100-ms steps (1.0 - 1.5).

**Parameter 2** FB 0 - 10

Adjusts number of repeat cycles (feedback) for delay sound.

**Parameter 3** MIX  0 - 30

Adjusts delay sound level.

**TYPE 6 DLYHAL (Delay + Hall Reverb)**

This is a combined delay and hall reverb effect.

**TYPE 7 DLYROM (Delay + Room Reverb)**

This is a combined delay and room reverb effect.

\* Parameters for DLYHAL and DLYROM are the same.

**Parameter 1** DLYTIM 1 - 50

Adjusts delay time in 10-ms steps.

**Parameter 2** DLYMIX  0 - 15

Adjusts delay sound mix.

**Parameter 3** REVMIX  0 - 15

Adjusts reverb sound mix.

**TYPE 8 HLDDLY (Hold Delay)**

This is a hold delay effect that lets you record a phrase of up to 2 seconds during a performance and play it back repeatedly.

When "Mn" (Manual) is selected and a foot switch is pressed, recording is carried out until the switch is pressed again or until 2 seconds have elapsed.

**Parameter 1** TIME 1 - 99, 1.0 - 2.0, Mn

Adjusts recording time from 10 ms to 990 ms in 10-ms steps (1 - 99), and from 1.0 to 2.0 seconds in 100-ms steps (1.0 - 2.0). When "Mn" (Manual) is selected, recording is carried out for as long as a foot switch is depressed (up to the maximum of 2 seconds).

**Parameter 2** MODE  nL, So, rS

Selects playback mode for recorded phrase.

- nL (Normal): Normal direction playback
- So (Sound-on-sound): Recorded contents are played back repeatedly to create an overlay.
- rS (Reverse): Reverse direction playback

**Parameter 3** MIX  0 - 30

Adjusts effect sound mix.

**TOTAL Module**

The TOTAL module is not an independent effect module. Rather it serves to set parameters that affect all patches or the entire 708II. There are three pages with parameters. Use the [EDIT] key to switch between pages.

**■ PAGE 1**

**Parameter 1** PATLVL 1 - 30

Sets final patch level. A setting of 25 means that input signal and output signal levels are equal.

**Parameter 2** Specifies input position.

**Parameter 3** Selects a character.

Parameter knobs 2 and 3 let you input or edit a patch name. Knob 2 specifies the character input position, and knob 3 selects the alphanumeric character to be input at that position.

**■ PAGE 2**

**Parameter 1** PTN Pattern name

Selects rhythm pattern to be assigned to a patch. For details on how to assign rhythm patterns to a patch, see p. 26.

**Parameter 2** PDLMIN 0 - 10

Sets minimum parameter value when expression pedal is fully raised.

**Parameter 3** PDLMAX 0 - 10

Sets maximum parameter value when expression pedal is fully lowered.

For details on how to set the pedal range for each patch, see p. 23.

**■ PAGE 3**

**Parameter 1** SP NO 1 - 60

Selects a sample to assign to a patch. For details on how to assign a sample to a patch, see p. 27.

**Parameter 2** SPMODE n1, n2, P2, n4, P4

Selects the sample playback mode, as follows.

- n1 Normal speed playback
- n2 Half tempo, half pitch playback
- P2 Half tempo, normal pitch playback
- n4 Quarter tempo, quarter pitch playback
- P4 Quarter tempo, normal pitch playback

**Parameter 3** SP LVL 0 - 30

Adjusts sample playback level.

# Troubleshooting

## ■ No sound, or very low volume

- Is the correct AC adapter connected, and the power switch set to ON?

Refer to "Getting Connected" on page 7 and turn the power on.

- Are [INPUT] jack and [OUTPUT/PHONES] jack connected correctly to the instrument and amplifier?  
Refer to "Getting Connected" on page 7 and establish correct connections. Check volume settings at instrument and amplifier.
- Is the shielded cable defective?  
Try replacing the cable.
- Is 708II set to mute condition?  
Cancel the mute condition.
- Is [OUTPUT] knob turned down?  
Set knob to suitable position.
- Is expression pedal raised?  
For some patches, the expression pedal controls the volume. Set it to a suitable position.
- Is the PICKUP SELECTOR module set correctly, according to the pickup type of the bass guitar?

## ■ Cannot record from [AUX IN] jack

Is input source set to "BASS"? Set it to "AUX".

## ■ Sound is unnaturally distorted

- Is the PICKUP SELECTOR module set correctly, according to the pickup type of the bass guitar?

- Adjust LEVEL parameters of modules, and GAIN parameter of DRIVE module.

## ■ High noise levels

- Adjust ZNR parameter. If problem persists, try reducing GAIN.
- Is the PICKUP SELECTOR module set correctly, according to the pickup type of the bass guitar?

## ■ Cannot play rhythm pattern or volume is very low

- Is rhythm volume set to low value?  
Adjust parameter knob 3 to obtain suitable volume.

## ■ Expression pedal on/off switching does not work properly.

- Try the procedure described in "Adjusting the Expression Pedal" on page 25.

## ■ SmartMedia card cannot be used

- Is [SMART MEDIA] LED lit?  
Turn unit off and check whether SmartMedia card is inserted properly.
- Is correct SmartMedia card used?  
The 708II can use SmartMedia cards with a capacity from 16 to 128 MB (designed for 3.3V).
- Has SmartMedia card been formatted?  
Be sure to format the SmartMedia card in the 708II before use, as described on page 31.

# Specifications

◆ Effect Programs	69 types
◆ Effect Modules	7 modules
◆ Sampler Function	Maximum recording duration 6 seconds (without SmartMedia) 16-bit linear record/playback (MOD and REV modules are temporarily turned off when sampler function is used)
◆ Patch Memory	USER: 6 banks x 10 = 60 (rewritable, with store) PRESET: 6 banks x 10 = 60 Total 120 patches
◆ Sampling Frequency	31.25 kHz
◆ A/D Conversion	20-bit, 64-times oversampling
◆ D/A Conversion	20-bit, 8-times oversampling
◆ Input	Bass input: standard mono phone jack (nominal input level -20 dBm, input impedance 500 kilohms) AUX IN: miniature stereo phone jack (nominal input level -20 dBm, input impedance 20 kilohms)

◆ Output	Combined line/headphone output Standard stereo phone jack (maximum output level = +3 dBm with output load impedance of 10 kilohms or higher)
◆ Display	6-position alphanumeric LED display 2-position 7-segment LED display
◆ Power Requirements	AC adapter (available separately) 9 V DC, center minus, 300 mA (ZOOM AD-0006) Batteries: IEC R6 (size AA) x 4 Continuous operation: approx. 11 hours (with alkaline batteries)
◆ External Dimensions	249 mm (W) x 195 mm (D) x 57 mm (H)
◆ Weight	860 g (without batteries)

\* 0 dBm = 0.775 Vrms

\* Design and specifications subject to change without notice.

## Patch List

### BANK A DEMO

Patch	NAME		PEDAL
0	POWER	Powerful bass sound	VOLUME
1	CHORUS	Clean chorus sound	CHORUS
2	ARGUS	Heavy-bottomed sound with octave fuzz	OCTFUZ
3	SYNTHV	Vintage synthesizer bass sound	[ P-WAH ]
4	SHAPUP	Solid dynamic sound	P-PIT
5	WAH	Funky wah sound	VOLUME
6	R'GIG	Great for rock'n roll to hard rock	OD
7	FUZZUP	Bass solo sound with fuzz	P-PIT
8	NOFRET	Lead fretless sound	VOLUME
9	VINPHA	Phase sound with distortion	PHASE

### BANK d LINE

Patch	NAME		PEDAL
0	SMOOTH	Smooth sound with soft feeling	VOLUME
1	SWP	High-powered slap sound	VOLUME
2	PPVIBE	Combination of vibe and ping-pong delay	PP-DLY
3	HARD	Sound for picking or slap style playing	THRASH
4	PRACTI	Practical sound for everyone	VOLUME
5	R'RIFF	Riff phrase sound with higher-octave component	PITCH
6	PCKBET	Beat sound for picking	BOOST
7	MIDBOX	Box amp type sound	MN-DLY
8	LOWENH	Low-enhanced sound	LO-ENH
9	SYNTH	ZOOM original bass synthesizer sound	STDSYN

### BANK b ARTIST

Patch	NAME		PEDAL
0	MIRROR	Marcus simulation	VOLUME
1	JACOP	Jazz rear picking sound	ROOM
2	GRAND	Graham sound simulation	VOLUME
3	STNGRY	Stingray sound simulation	VOLUME
4	LIVE	Stage sound with rich lows	HALL
5	NY80'S	Brecker's Lee sound in eighties N.Y. style	VOLUME
6	CHORD	Sound for chord playing	CHORUS
7	FUNK	Power compression type classic funk sound	COMP
8	TAP	Tapping distortion sound	SP OD
9	FLG FZ	Sound for detailed picking and power chords	FUZZ

### BANK E VARIATION

Patch	NAME		PEDAL
0	NOISY	Simulated VCO modulated by noise	OCTFUZ
1	OD	Simulated compact overdrive	SP OD
2	ENHANC	Simulated compact enhancer	VOLUME
3	JC VIB	Sound modeled after combo amp vibrato	VIBE
4	D-TONE	Drive sound for rock	AC DRV
5	2OCTLD	Oct +2 oct sound	VOLUME
6	PROGRE	Progressive sound	FLANGE
7	MELODY	Great sound for melody picking	DLYHAL
8	MBOOST	Midrange-enhanced sound	APG 15
9	FUNK-W	Synthesizer style funk wah sound	CMPOCT

### BANK C MULTI/SFX

Patch	NAME		PEDAL
0	LEAD-W	Wah sound for lead playing	PP-DLY
1	FLGBRT	Bright flanging sound	ROOM
2	FZLEAD	Rock fuzz sound	OCTFUZ
3	TREMOL	Tremolo bass sound	TREMOL
4	SYTALK	Talk synthesizer sound	ROOM
5	BENDER	Attack-based bending sound	DLYHAL
6	STRING	Classical strings sound	SLOW-A
7	RING	Metallic SFX sound	RING-M
8	TIME	Ephemeral SFX sound	T-TRIP
9	STEP	ZOOM original step sound	STEP

### BANK F MODELING

Patch	NAME		PEDAL
0	FDR	Simulated American stack amp	VOLUME
1	A-PEG	B-15 sound	VOLUME
2	MS DRV	MS rock sound	VOLUME
3	TET	Simulated British stack amp	VOLUME
4	SWX	SW sound	VOLUME
5	B-MAN	Overdrive sound for picking	VOLUME
6	HEART	Simulation of amp with aluminum cone speaker	VOLUME
7	SP SV	Typical APG stack amp sound	VOLUME
8	BGI	Simulated BG amp	VOLUME
9	AC STK	AC drive sound	AC DRV



### ZOOM CORPORATION

NOAH Bldg., 2-10-2, Miyanishi-cho, Fuchu-shi, Tokyo 183-0022, Japan

PHONE: +81-42-369-7116 FAX: +81-42-369-7115

Web Site: <http://www.zoom.co.jp>