

ZOOM

ZOOM PLAYER
ADVANCED GUITAR EFFECTS PROCESSOR

30000

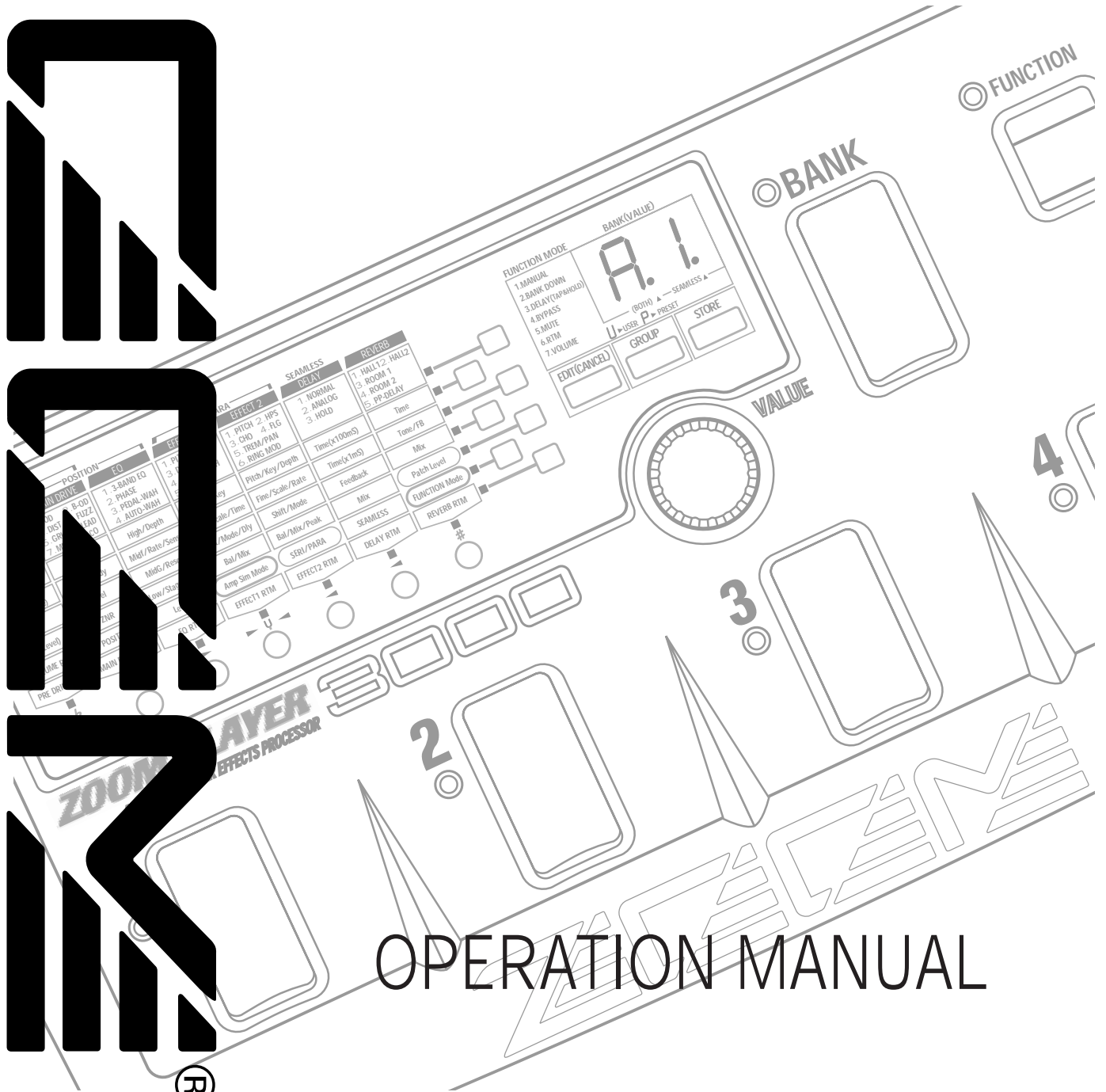

OPERATION MANUAL

®

CONTENTS

Introduction	1	Other Functions	28
		Using the Amp Simulator	28
Names of Parts	2	Returning the 3000 to the Factory Default	
Top Panel View	2	Settings (All Initialize/Factory Recall)	29
Rear Panel View	2		
Getting Connected	3	Using the Talking Box Effect	30
Before Playing	3	Connecting the Microphone	30
		Using the Microphone to Control	
Introducing the 3000	4	the Talking Box Effect	30
Outline	4		
Patches and Parameters	5	Using the Remote Pedal	32
Global Parameters	5	RP01 Names of Parts / Connections	32
Operation Modes	5	Using the RP01 for Controlling the RTM	
		Target Parameter (RTM Mode)	33
Let's Try Out Some Patches		Using the RP01 for Delay Tap Input or	
(Play Mode Operation)	6	Hold Delay Operation (DELAY Mode)	35
Display for Play Mode Panel	6		
Selecting a Patch	7	Effect Types and Parameters	36
Adjusting the Master Volume	8	PRE DRIVE	36
Temporarily Switching Effects Off		MAIN DRIVE	37
(Bypass Function)	9	EQ	39
Temporarily Turning the Sound Off		EFFECT1	40
(Mute Function)	10	EFFECT2	42
Tuning Your Guitar (Autotuner Function)	11	DELAY	43
Adjusting the Standard Pitch of the Tuner		REVERB	45
(Calibration)	12		
		Troubleshooting	46
Changing the Patch Sound			
(Edit Mode Operation)	13	SPECIFICATIONS	48
Switching between Edit			
and Play Modes	13	USAGE AND SAFETY	
Panel Display in Edit Mode	14	PRECAUTIONS	49
Switching Effect Modules On/Off	15	USAGE AND SAFETY PRECAUTIONS	49
Changing Parameter Settings of Effects	16	Usage Precautions	49
Storing Patches	17		
Using the FUNCTION switch	18		
Assigning a Function to			
the FUNCTION Switch	18		
Manual Mode	20		
Delay Time Tap Input	21		
Using Hold Delay	22		
Adjusting Effect Parameters			
in Real Time (RTM)	23		
Controlling the Volume in Real Time			
(VOLUME RTM)	26		

Introduction

Thank you for selecting the ZOOM PLAYER 3000 (hereafter simply called the "3000").

The 3000 is a multi-effect device with the following features:

- Furnishes 37 types of diverse single effects; also contains an amp simulator and noise reduction function (ZNR). A maximum of nine effects can be combined freely.
- The effects can be used by switching among a maximum of 40 user and 40 preset types of patches (for a total of 80 patches).
- Two types of distortion effects can be used simultaneously. This allows creating a wide variety of distortion and overdrive sounds not possible with a conventional multi-effect device.
- Built-in harmonized pitch shifter (HPS) performs intelligent pitch shift matching the scale being played.
- Unique TALKING BOX effect allows use of a connected microphone to create a talking simulator sound.
- Seamless patch change function assures smooth transitions by allowing the delay of the previous patch to continue after the patch has been switched.
- User-definable function switch can be adapted for bypass or muting, and can also serve as a controller for changing effect parameters or level settings in real time. Even without additional equipment, the 3000 allows a wide variety of expression styles.
- Optional remote pedal RP01 can be used to control effect parameters and volume from any convenient spot. Use as a pedal wah or pedal pitch shifter is also possible.
- Tap input lets you match the delay time to the tempo of the current song, using the function switch or remote pedal. These also are handy for the hold delay function which automatically repeats phrases played on the instrument.
- Three types of amp simulators generate a guitar amp sound for audio speakers and headphone monitors.
- Incorporates an auto-chromatic tuner for guitar, enabling easy tuning on stage.

Please take the time to read this manual carefully so as to get the most out of your 3000 and to ensure optimum performance and reliability.

Names of Parts

Names of Parts

Top Panel View

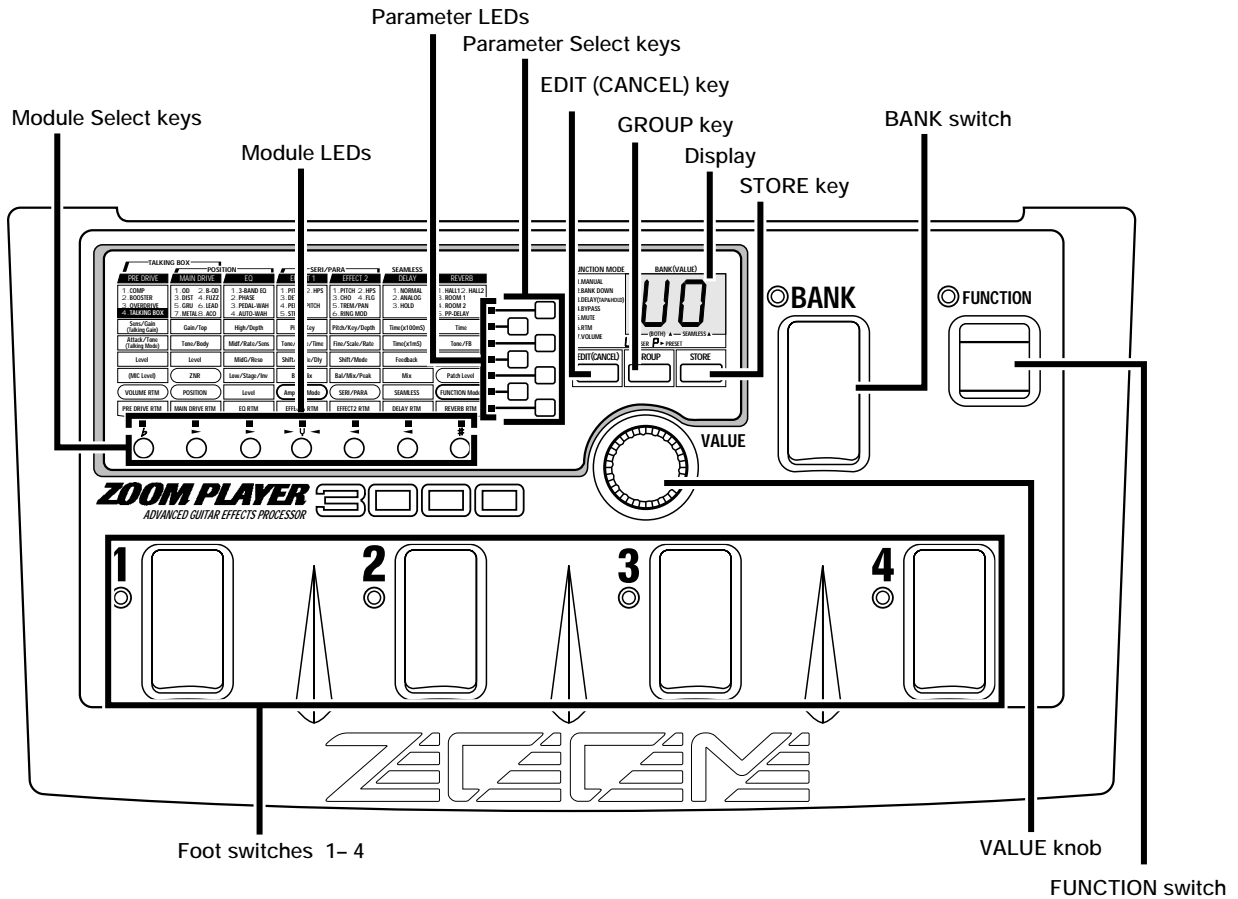

Rear Panel View

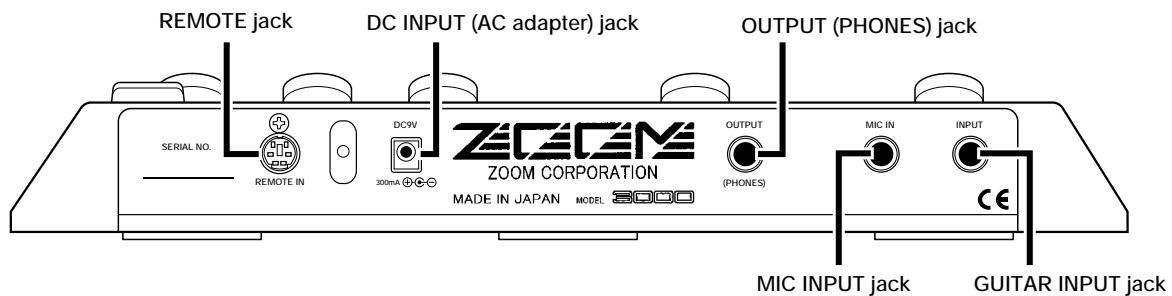

Getting Connected

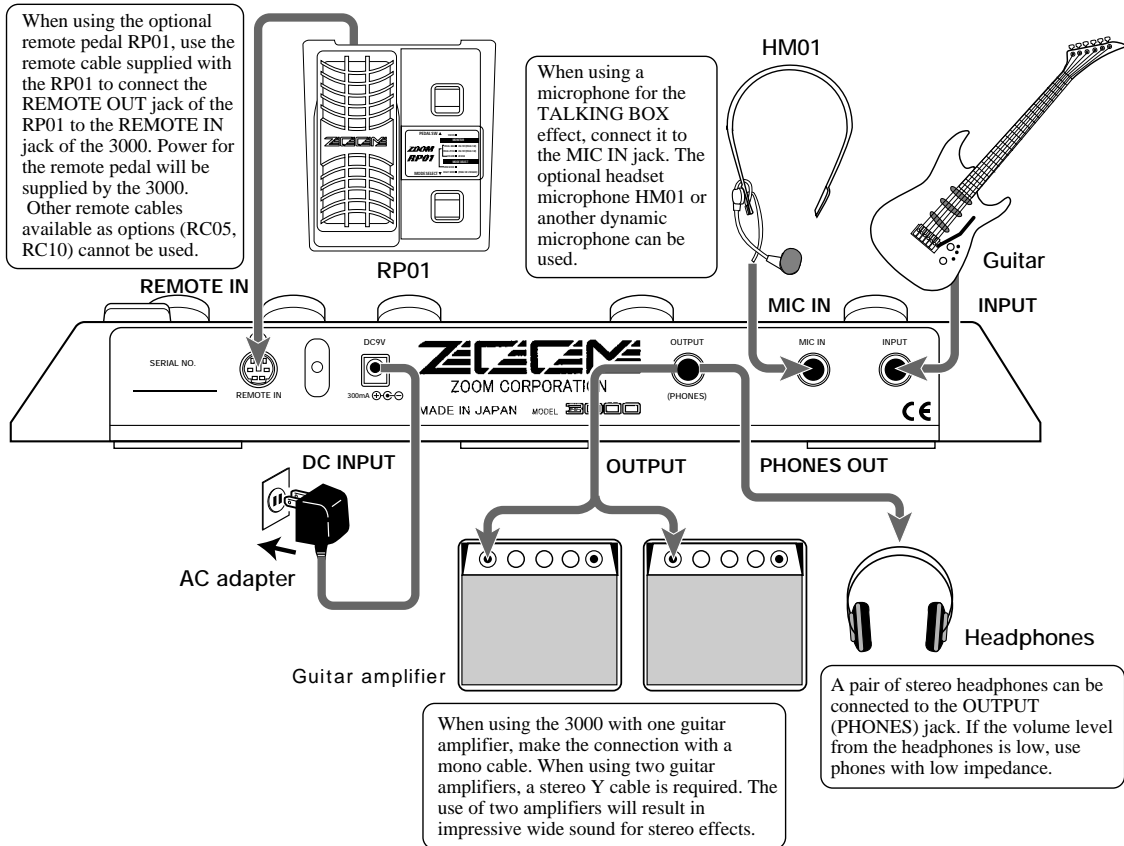

Before Playing

After completing connection, the volume has to be adjusted according to the following procedure.

STEP 1 Cut the power to the amplifier, turn the volume down to its minimum level, and connect the 3000 correctly to the musical instrument and amplifier

STEP 2 Power up the 3000.

Connect the accessory AC adapter to the DC INPUT jack. The power to the 3000 is ON when the AC adapter is plugged into a power outlet.

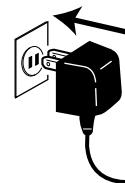

STEP 3 Switch ON the power to the amplifier.

Adjust the volume of the musical instrument and the amplifier while playing the instrument.

Introducing the 3000

Outline

The 3000 is a multi-effect processor featuring seven effect modules (effect blocks). Each effect module works as a single effect, equivalent to a compact effect device. In other words, the 3000 can be thought of as functioning in the same way as seven compact effect devices linked together. A compact effect device comes with knobs for adjusting the type of effect and depth. Similarly, the effect modules have parameters that determine the type of effect and depth.

Effect modules

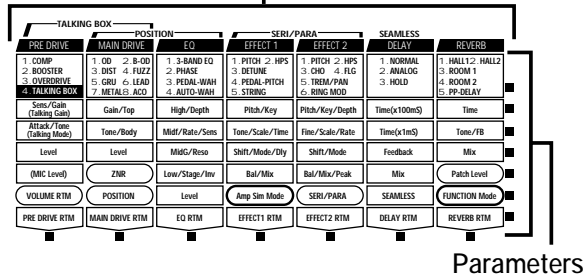

Take a look at the top panel of the 3000. At the top left, you will see the effect modules (PRE DRIVE - REVERB) arranged in a horizontal row. The various parameters (1 - 7) which together form the effect module are listed vertically under the module name. (Some parameters are independent of effect modules, and some are general parameters which work on the entire 3000.)

The 3000 effect modules are of the following types:

- **PRE DRIVE** This effect module provides light distortion and also includes settings for the talking box effect for use with a microphone (4 effect types).
- **MAIN DRIVE** This effect module provides hard distortion and high-gain sound effects. Settings for the acoustic guitar simulator are also part of this module (8 effect types).
- **EQ** The built-in three-band equalizer allows separate boost or cut in the low, mid, and high frequency range. Phaser and wah settings also belong to this module (4 effect types).
- **EFFECT1** This is the pitch shifter effect module (5 effect types).
- **EFFECT2** This is the modulation effect module (6 effect types).
- **DELAY** This is the delay effect module (3 effect types).
- **REVERB** This is the reverb effect module (5 effect types).

All effect modules have several effect types, that is variations which result in different sound. These are called "effect type". One effect type can be selected for each effect module.

The following diagram shows the signal flow in the 3000, and the effect types that can be selected for each effect module.

*1 The MAIN DRIVE module and EQ effect module can be connected in three different ways: parallel connection, serial connection in the order MAIN DRIVE → EQ, or serial connection in the order EQ → MAIN DRIVE.

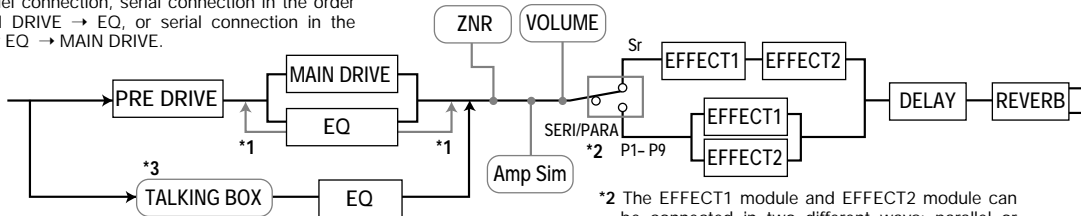

*2 The EFFECT1 module and EFFECT2 module can be connected in two different ways: parallel or serial.

*3 When the TALKING BOX effect has been selected for the PRE DRIVE module, the MAIN DRIVE module cannot be used, and the signal is sent directly to the EQ module.

Patches and Parameters

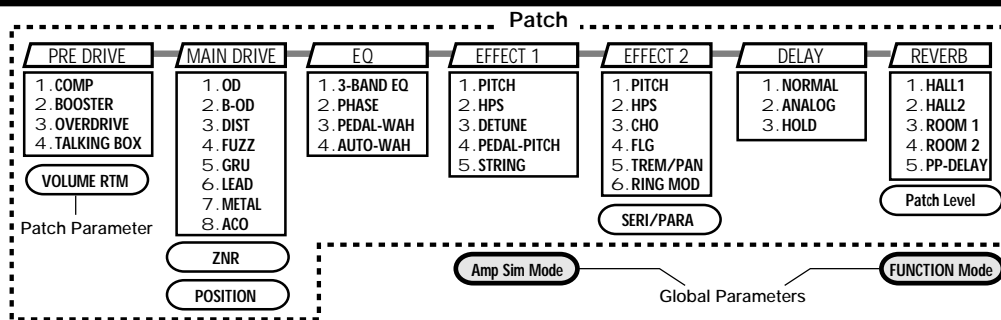

Internal settings for the 3000 can be stored in memory and retrieved from memory in units called "patches".

A patch is a combination of up to seven effect modules. The patch comprises the parameter settings for the effect modules, as well as information about ZNR settings, signal routing, etc. The section enclosed by a dotted line in the above illustration is a patch.

The storage for patches in the 3000 accommodates two types of groups, the USER group that can be freely created, altered and stored by the user, and the read-only PRESET group that is factory-defined. Each group supports 40 types of patches, for a storage total of 80. When using the 3000, you can call up these patches instantly by pressing the foot switch on the panel.

Also, the parameters comprising the patches can be adjusted, and stored in the USER group. In the 3000, patches are invoked in sets of four, and patches can be changed by using the Foot Switches. These sets of four patches are called "banks". The USER group and the PRESET group each have banks numbered from 0 through 9. To select a patch, first switch to the appropriate bank number and then select the desired patch.

Global Parameters

Besides the parameters for individual effect modules, the 3000 also has global parameters which work on all patches.

When a global parameter is adjusted, its effect will remain even when the patch is switched. However, if the unit is turned off without storing a patch, the global parameter setting will revert to the previous value. When wishing to keep the new global parameter setting, choose any patch from the USER group and store it, as described on page 17.

Operation Modes

The workings of the 3000 can be divided into major function categories according to their purpose. These functions are called "modes". The 3000 has the following four modes:

- **Play mode** For performance In this mode, you perform by selecting a patch and using an effect. You can turn the effect sound off temporarily, and use the tuning function in this mode.
- **Manual mode** In this mode, effect modules can be switched on and off individually, using the BANK switch and Foot Switches 1 - 4 on the top panel. This is suitable for use during a performance.
- **Edit mode** In this mode, the effect parameters of the currently selected patch can be edited (changed) by the user. Global parameters are also set in this mode.
- **Special mode** This mode serves for initializing the 3000. USER group settings and patches can be selectively returned to the factory default.

Let's Try Out Some Patches (Play Mode Operation)

The Play mode is for selecting a patch and playing. When you power up the 3000, it automatically activates in Play mode, and the USER group's Bank 0, Patch Number 1 is selected.

Display for Play Mode Panel

In Play mode, the display LEDs on the panel show the following information:

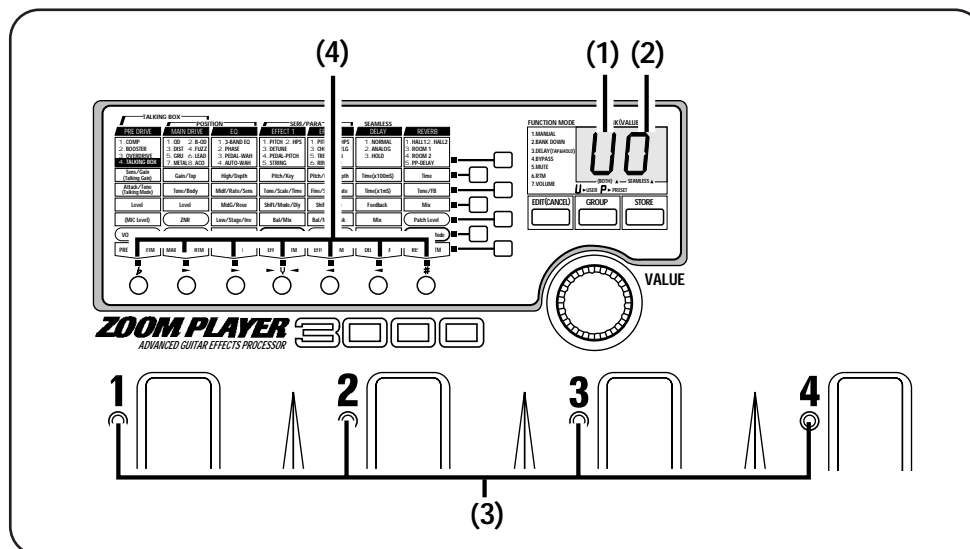

(1) Group

The type of group currently selected is indicated in the left side of the display.

(2) Bank Number

The currently selected bank number is indicated in the right side of the display.

(3) Patch Number

The LED of the Foot Switch 1 - 4 corresponding to the currently selected patch number lights up.

(4) Effect Module ON/OFF

The panel module LEDs light for the effect modules are that is on in the currently selected patch.

Selecting a Patch

In the Play mode, you can play by choosing one of the patches from among the 80 types (40 USER group patches plus 40 PRESET patches) in memory.

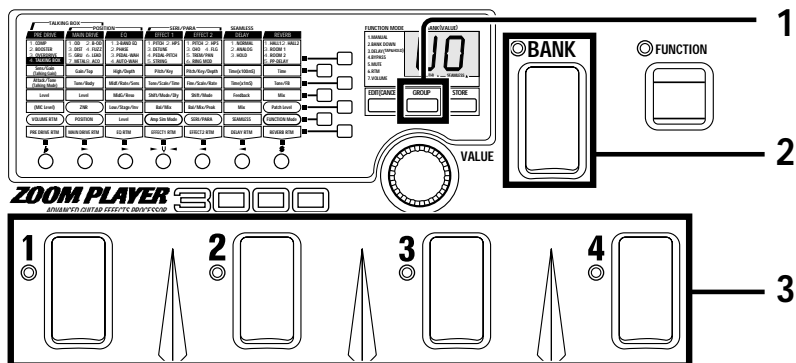

STEP 1 Press the GROUP key to select the group.

When choosing a patch, first decide which group of patches you want to use. With each push of the GROUP key, the left side of the display changes in the following sequence.

- U (USER) Only USER group patches can be used.
- P (PRESET) Only PRESET group patches can be used.
- U. or P. (BOTH) Patches of both USER and PRESET groups can be used.

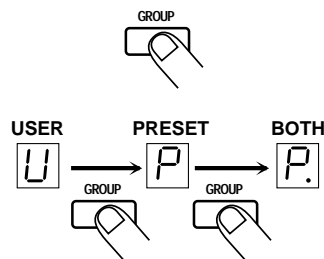

STEP 2 Select a bank by stepping on the BANK switch.

Each time you step, you change to the next higher bank number. (The bank number flashes.)

HINT In this status, the patch will not yet be changed

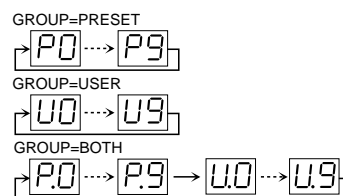

STEP 3 Step on a Foot Switch (1 - 4) to select a patch.

The LEDs lights for the Foot Switch you stepped on, telling you that a patch has been selected. Also, the indicated bank number changes from flashing to constantly lit display.

HINT Here, try switching the patches while you are actually playing your instrument, and find out what types of patches are stored in the 3000.

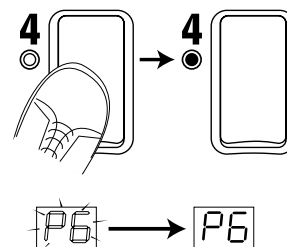

(Play Mode Operation)
Let's Try Out Some Patches

Adjusting the Master Volume

In Play mode, regardless of the selectable patches, the final volume output by the 3000 can be controlled by the Master Volume.

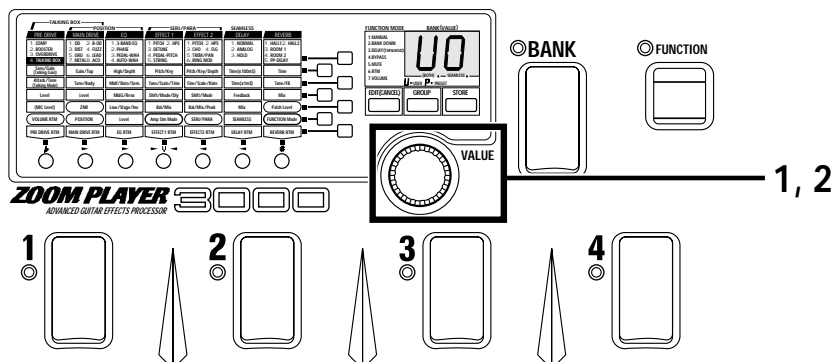

STEP 1 Operate the VALUE knob.

The display will indicate the current value (1 - 50) of the Master Volume for one second (default setting: 40).

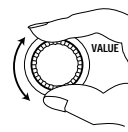

40

STEP 2 While the value is displayed, use the VALUE knob to adjust the volume to the desired level.



- The Master Volume setting works in common for all patches. It cannot be stored for separate patches.
- If you want to change the volume for specific patches, adjust the patch level in Edit mode. For details, see page 45.

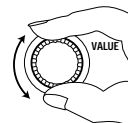

The master level setting cannot be stored. It needs to be adjusted every time the unit is turned on.

40 → 41

Temporarily Switching Effects Off (Bypass Function)

You can switch the 3000 Effect mode OFF temporarily (this is called "bypass"), and monitor the instrument's direct sound. This is a handy function for checking how the effects are working.

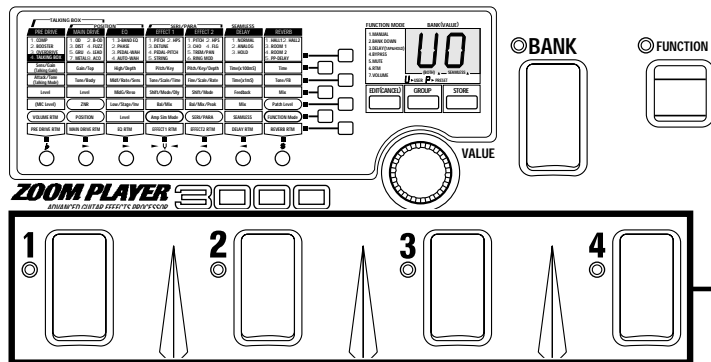

STEP 1 Step on the Foot Switch for the currently selected patch number (the Foot Switch whose LED is lit) and release your foot straight away.

If you lightly step on the Foot Switch and then release your foot within a second, the 3000 will enter the Bypass status. The LED for the currently selected patch will flash, and the module LED will light. Also, the display will indicate the Bypass status with "bP", and then change to "--".

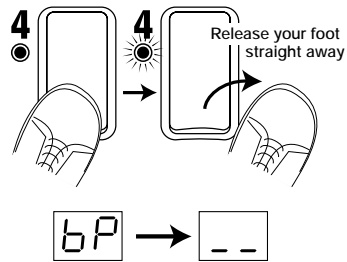

STEP 2 To release this status, lightly step on and release your foot from the Foot Switch again, or select another patch.

The 3000 will return to the usual Play mode.

HINT The FUNCTION switch can also be used to activate the Bypass function. For details, please refer to page 19.

NOTE When the FUNCTION switch mode is set to bypass or mute, step 1 is invalid. When not wishing to use the Foot Switches 1 - 4 for on/off switching of the bypass or mute condition, set the FUNCTION switch mode to BYPASS or MUTE.

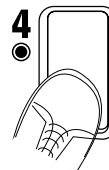

(Play Mode Operation)
 Let's Try Out Some Patches

Temporarily Turning the Sound Off (Mute Function)

The mute function temporarily turns the output OFF.

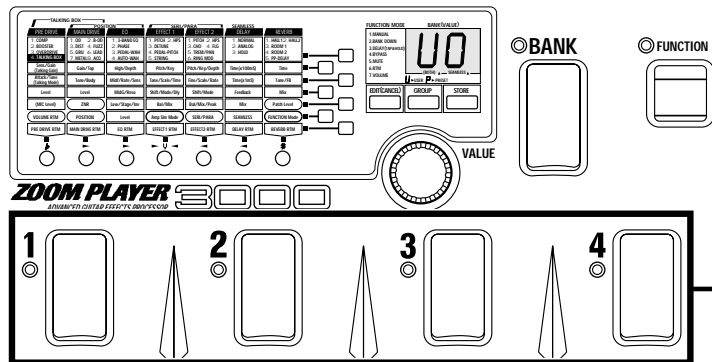

Let's Try Out Some Patches (Play Mode Operation)

STEP 1 Step on the Foot Switch whose LED is currently lit, keep your foot pressed on the switch for a moment, and then release it.

If you have stepped for more than a second on the Foot Switch whose LED is lit, both effect sound and direct sound will be silenced (muted). The LED for the currently selected patch will flash, and the module LED will light. Also, the display will indicate the Mute status with "MUTE", and then change to "--".

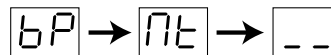
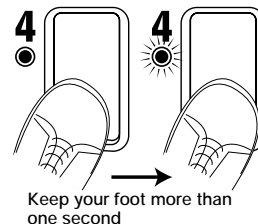

STEP 2 To release this status, step on the Foot Switch again, or select another patch.

The 3000 will return to the usual Play mode.

HINT The FUNCTION switch can also be used to activate the Mute function. For details, please refer to page 19.

NOTE When the FUNCTION switch mode is set to bypass or mute, step 1 is invalid. When not wishing to use the Foot Switches 1 - 4 for on/off switching of the bypass or mute condition, set the FUNCTION switch mode to BYPASS or MUTE.

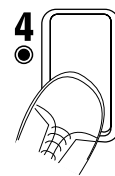

Tuning Your Guitar (Autotuner Function)

The 3000 supports a chromatic autotuner function. This function can be used automatically in Bypass or Mute status.

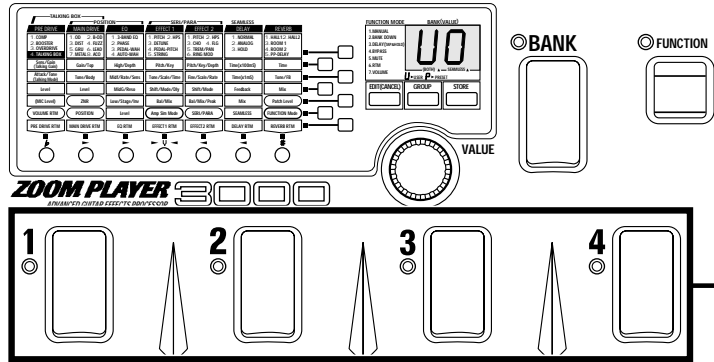

(Play Mode Operation)
 Let's Try Out Some Patches

STEP 1 Lightly step on the Foot Switch whose LED is currently lit in the display for Foot Switches 1 - 4, and release your foot straight away.

The 3000 will enter the Bypass status, and you can use the autotuner function. The display will indicate "bP", and the module LEDs will light.

HINT The autotuner function can be used when the 3000 is in Mute status. This is handy for tuning on stage when you do not want to produce the sound externally.

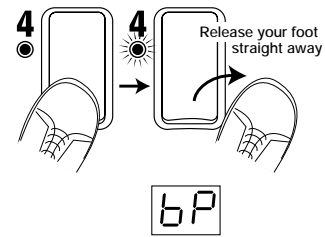

STEP 2 Pick a released string.

The display shows the tone closest to the current pitch. Tune the guitar until it matches the desired tone.

HINT For tuning an electric bass, use 12F harmonics and tune with the sound an octave higher.

C = C	F = F	A = A
C# = C#	F# = F#	A# = A#
D = D	G = G	B = B
D# = D#	G# = G#	
E = E		

STEP 3 When the display shows the desired tone, perform fine tuning until the EFFECT1 module LED lights up.

When the tuner function is ON, the module LED works as a meter, measuring the accuracy of the tuning. If the pitch matches accurately, the middle LED (the EFF1 module LED) lights.

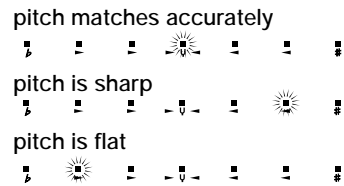

STEP 4 Press the Foot Switch again, or select another patch.

The 3000 returns to the Play mode.



Adjusting the Standard Pitch of the Tuner (Calibration)

Set the internal standard pitch (calibration).

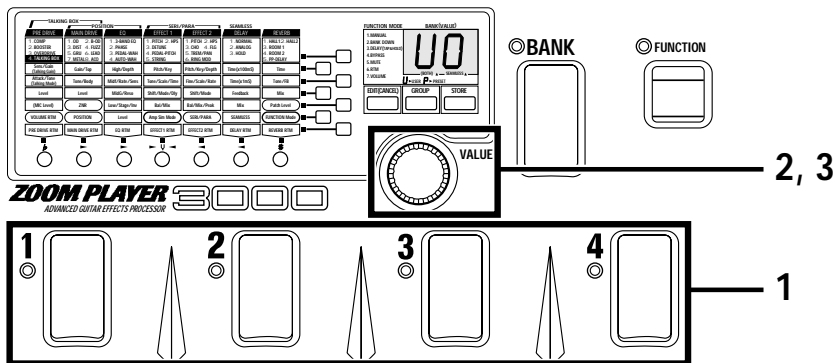

Let's Try Out Some Patches (Play Mode Operation)

STEP 1 Invoke the Bypass status by lightly stepping on and releasing your foot from the Foot Switch whose LED is currently lit in the display for Foot Switches 1 - 4.

The display will indicate "bP", and the module LEDs will light.

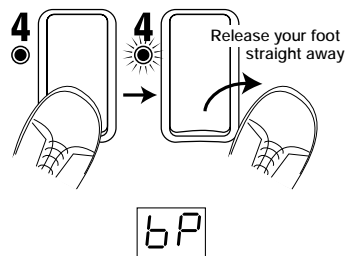

STEP 2 Operate the VALUE knob.

The display will indicate the current calibration value for one second.

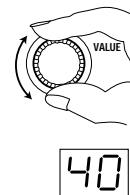

STEP 3 While the value is displayed, use the VALUE knob to set the desired value.

Calibration is within the range of "35" (A = 435 Hz) and "45" (A = 445 Hz).

NOTE Every time the unit is turned on, the calibration value is reset to A = 440 Hz.

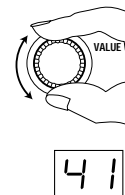

435Hz : 35
440Hz : 40
445Hz : 45

Changing the Patch Sound (Edit Mode Operation)

This section describes the basic operation of the Edit mode. The patches of the 3000 are made up from a variety of parameters that determine the sound as well as parameters that are independent of patches, such as ZNR sensitivity settings, module connection routing, etc. In the Edit mode, parameters can be changed to fit your personal preferences. Most global parameters are also set in this mode.

Switching between Edit and Play Modes

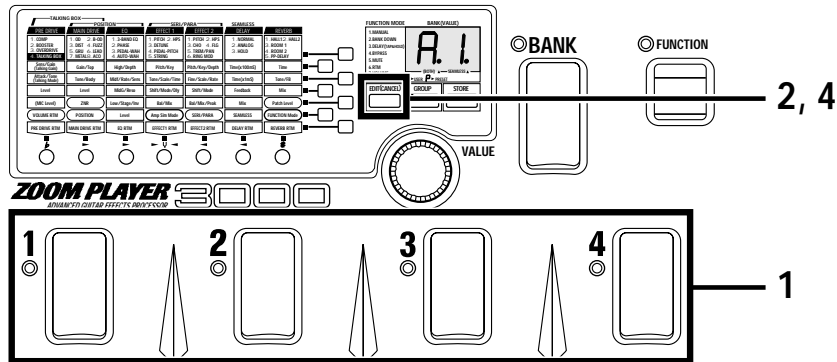

STEP 1 In the Play mode, choose the patch you want to edit. (This can be from the USER or PRESET group.)

STEP 2 Press the EDIT key.

The 3000 enters Edit mode, so that you can edit parameters.



STEP 3 Perform editing.

The editing methods are explained in detail on the following pages.

STEP 4 When you have finished editing, press the EDIT key again.

The 3000 returns to the Play mode.



(Edit Mode Operation)
Changing the Patch Sound

Panel Display in Edit Mode

In Edit mode, the panel displays the following information:

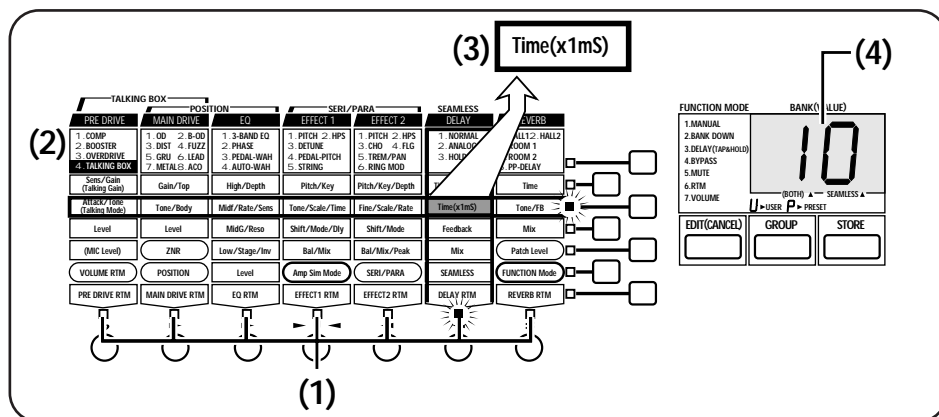

(1) Effect module ON/OFF

When the effect modules are ON in a patch, their corresponding module LEDs light.

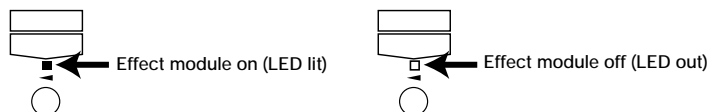

(2) Parameter type

On the top panel of the 3000, effect modules are arranged horizontally and effect parameters for the various modules are listed vertically (including patch parameters and global parameters).

(3) Currently selected parameter

The parameter at the point where the lines marked by the flashing module LED and flashing parameter LED cross is the parameter that is currently selected for editing. When an effect module is selected that is currently off, the flashing interval of the module LED changes (the off time becomes longer).

When selected effect module is on

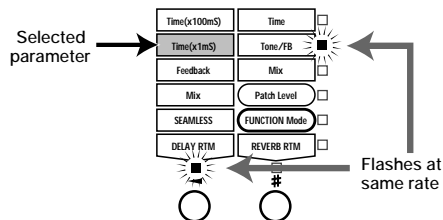

When selected effect module is off

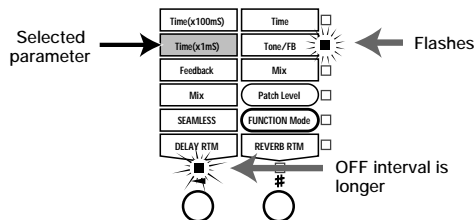

(4) Parameter value

The value of the parameter currently selected for editing is displayed. When the selected effect module is off, only "--" is displayed.

Effect module on



Effect module off

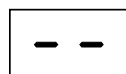

Depending on the type selected for the effect module, some parameters may have no setting item. When such a parameter is selected, the display shows "--.". For information on effect types and parameters, please refer to page 36.

Switching Effect Modules On/Off

In Edit mode, the effect modules can be switched on or off freely.

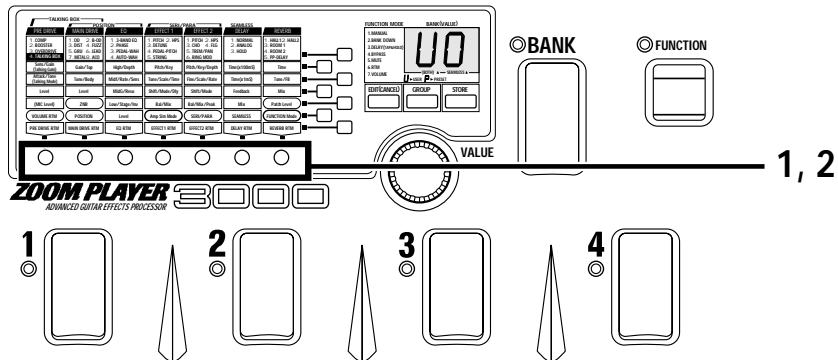

STEP 1 Use the Module Select keys to select the desired effect module.

In Edit mode, the module LEDs light for effect modules that are currently on. The LED for the module that is selected for editing flashes. By pressing the MODULE Select key directly under the module LED, this LED starts to flash.

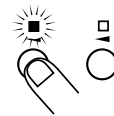

STEP 2 Pressing the MODULE Select key once more turns the effect module on or off.

The MODULE key can be used to toggle the module on or off. When off, the module LED goes out.

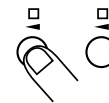

- The module on/off state can be stored as part of a patch, by performing the store operation as described on page 17.
- In Manual mode, the BANK switch and Foot Switches 1 - 4 can be used to switch modules on and off. For details, please refer to page 20.
- In Play mode, modules can be switched on and off by pressing the Module Select keys.

(Edit Mode Operation)
Changing the Patch Sound

Changing Parameter Settings of Effects

You can choose any parameter of an effect module and change the setting and value as desired.

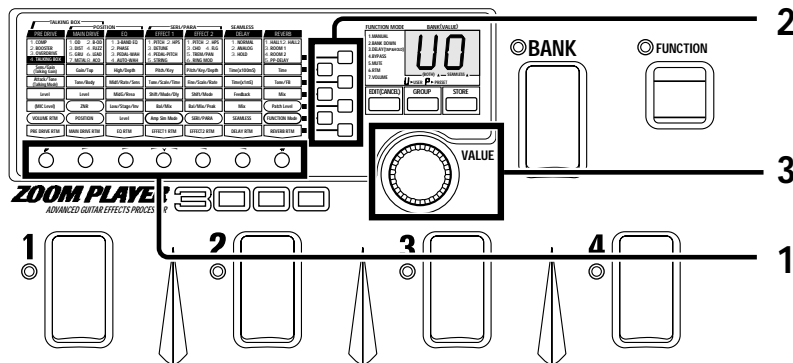

STEP 1 Use the Module Select keys to select an effect module.

The flashing module moves to the LED for the selected module.

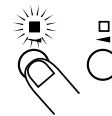

STEP 2 Use the Parameter Select keys to select the parameter.

The flashing parameter LED moves to the LED for the selected parameter.

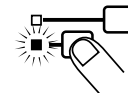

• When you have switched a module or parameter, the display changes accordingly.

- The settings of patch parameters and global parameters can also be changed in the same way.
- The topmost parameter controls the effect type. When the effect type is changed, the values of other parameters for that module also change. For the distortion effect types of the **PREDRIVE** and **MAIN DRIVE** modules and for the **DELAY** module, the content of the effect parameters does not change.

STEP 3 Operate the VALUE knob.

The current parameter value changes.



• For details about the types and functions of parameters of the effect modules, see page 36 -45 , "Effect Types and Parameters".

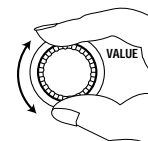

STEP 4 Change other parameters in the same way.



• The parameter changes made in this way are temporary. If you do not store the new settings, they will return to the original values when you return to Play mode and select another patch. (Global parameters revert to the original setting when the unit is turned off.) For information on storing patches, please refer to page 17.

Storing Patches

As long as you do not store in memory any patches edited in Edit mode, the original status will be returned when you select another patch. The following paragraphs describe how to store patches.

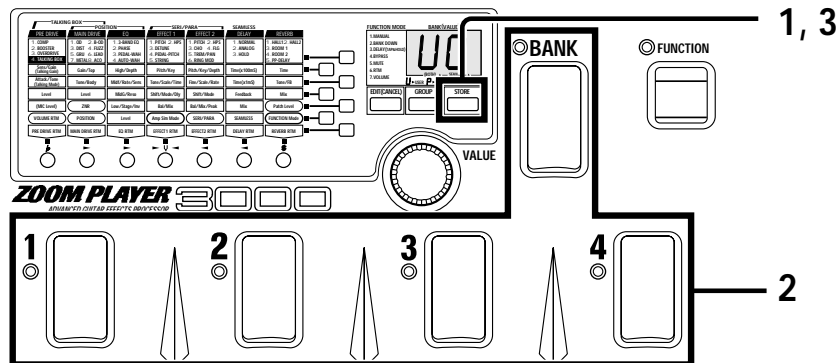

STEP 1 Press the STORE key.

This will invoke the store standby status, and the module LEDs, and parameter LEDs, will flash. In this status, you can specify the bank number and patch number of the storage destination.



NOTE Even though you can change the parameters of the patches of the PRESET group, you cannot write over them. Instead, when you have changed a patch of the PRESET group, the storage destination can only be "U" (USER group).

HINT You can store in either Play mode or Edit mode.

STEP 2 Using the BANK switch and Foot Switches 1 – 4, specify the patch storage destination.

If you do not make any particular specification, the destination will be the original patch of the USER group. When store has not been specified by the PRESET group, the patch is stored in Patch 1, Bank 0 of the USER group.

NOTE When you store parameters, the patch data already in the storage destination will be erased. Check to make sure you do not need the patch in the storage destination.



STEP 3 Press the STORE key again. This completes the storage operation, and returns the 3000 to the Play mode.

NOTE If the STORE key was not pressed for the second time, pressing the EDIT key will abandon the store procedure and return to the previous condition (before step 1).



Using the FUNCTION switch

The FUNCTION switch can be used to quickly activate muting or bypass, or to adjust the volume or effect parameters in real time.

Assigning a Function to the FUNCTION Switch

There are seven modes for the FUNCTION switch which can be selected by the user. To assign a function, perform the following steps.

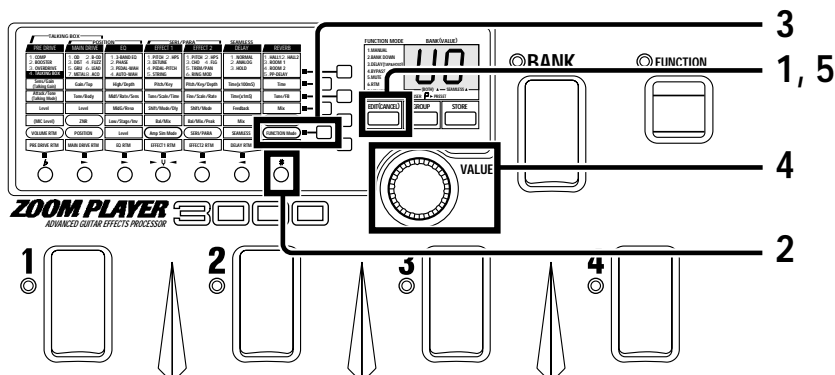

STEP 1 Press the EDIT key to activate the Edit mode.



STEP 2 Use the Module Select keys to select the REVERB module.

The module LED of the REVERB module starts to flash.



STEP 3 Use the Parameter Select keys to select parameter 6 (FUNCTION Mode).

FUNCTION Mode is a global parameter which serves to control the FUNCTION switch. The setting is not affected by the on/off status of the REVERB module.

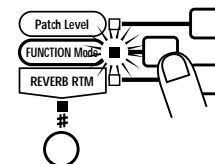

STEP 4 Use the VALUE knob to select one of the modes 1 - 7 listed below.

Seven modes are available for the FUNCTION switch, as described below.

1: MANUAL

Toggle between Manual mode and Play mode. For information on Manual mode, please refer to page 20.

2: BANK DOWN

Switch the bank to the next lower number (opposite direction from

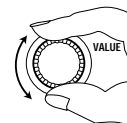

- the BANK switch).
- 3: DELAY (TAP&HOLD)
Allows tap input of the delay time and for operating the hold delay feature. For details, please refer to page 21, 22.
- 4: BYPASS
Toggle the bypass mode on and off. When this mode is selected, the Foot Switches 1 - 4 cannot be used to control step 1 of the bypass mode (page 9). When bypass is active, the FUNCTION LED is lit.
- 5: MUTE
Toggle the mute mode on and off. When this mode is selected, the Foot Switches 1 - 4 cannot be used to control the mute mode (page 10). When mute is active, the FUNCTION LED is lit.
- 6: RTM
Control a selected effect parameter in real time. For details, please refer to page 23.
- 7: VOLUME
Control the volume. For details, please refer to page 26.



The volume here refers to the input level of the EFFECT1 or EFFECT2 module. This is different from the patch level or master level.

STEP 5 Press the EDIT key once more.

The 3000 returns to the Play mode.

This completes the mode setting for the FUNCTION switch.



FUNCTION Mode is a global parameter whose setting does not change when a different patch is selected. If not stored, the setting reverts to the previous value when the unit is turned off and then on again. When wishing to store the setting, select any patch in the USER group and store it as described on page 17.



Manual Mode

In Manual mode, effect modules can be switched on and off individually during a performance. When the FUNCTION Mode parameter is set to "1", the FUNCTION switch can be used to toggle between Manual mode and regular Play mode. Manual mode operation is described below.

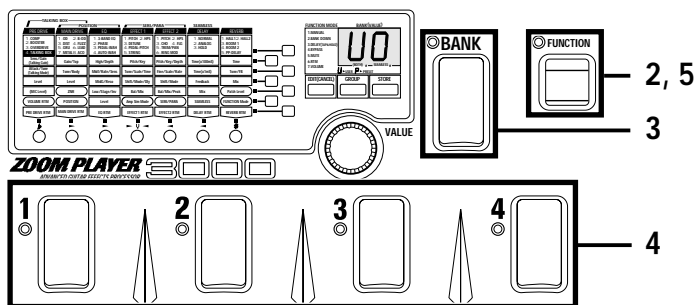

STEP 1 Set the FUNCTION switch to "1: MANUAL", as described on page 18.

STEP 2 Press the FUNCTION switch while the 3000 is in Play mode.

The indication "Fn" appears on the display.
The FUNCTION LED lights up.

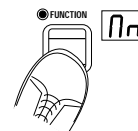

STEP 3 Use the BANK switch to select effect modules to be assigned to Foot Switches 1 - 4.

In Manual mode, the BANK Switch is used to assign effect modules to Foot Switches 1 - 4.

When the LED of the BANK switch is lit, the following effect modules can be assigned to the Foot Switches 1 - 4.

BANK switch LED lit	Foot switch	Corresponding effect module
	1	PRE DRIVE module on/off
	2	MAIN DRIVE module on/off
	3	EQ module on/off
	4	--

When the BANK switch was pressed and the LED flashes, the following modules can be assigned to the Foot Switches 1 - 4.

BANK switch LED flashes	Foot switch	Assignment
	1	EFFECT1 module on/off
	2	EFFECT2 module on/off
	3	DELAY module on/off
	4	REVERB module on/off



STEP 4 Use the Foot Switches 1 - 4 to turn the respective effect module on or off.

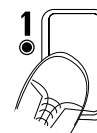

STEP 5 To switch to another patch, press the FUNCTION switch once more.

The FUNCTION LED goes out and the 3000 returns to Play mode.



Delay Time Tap Input

When the FUNCTION Mode parameter is set to "3: DELAY (TAP&HOLD)", the FUNCTION switch can be used to set the delay time for patches using the NORMAL or ANALOG effect type of the DELAY module. By using this function, you can easily set the delay time to match the music's tempo.

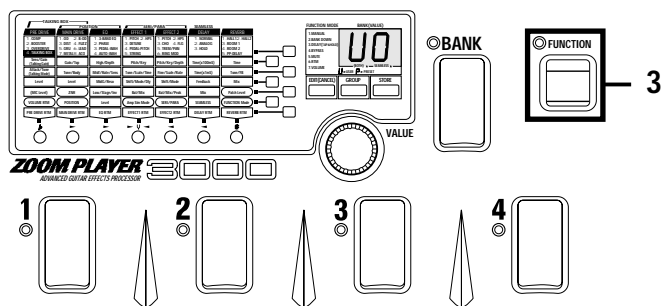

NOTE Select a patch which uses the NORMAL or ANALOG effect type of the DELAY module. To check the effect type, use the Edit mode. For details, please refer to page 14.

STEP 1 Set the FUNCTION Mode parameter to "3: DELAY (TAP&HOLD)".

The effect type setting can be checked in the Edit mode. For details, please refer to page 18, 19.

STEP 2 Step on the FUNCTION switch twice, to match the tempo.

The 3000 detects the interval in which the FUNCTION switch was pressed, and the delay time will be set in the DELAY effect module.

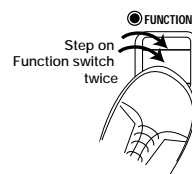
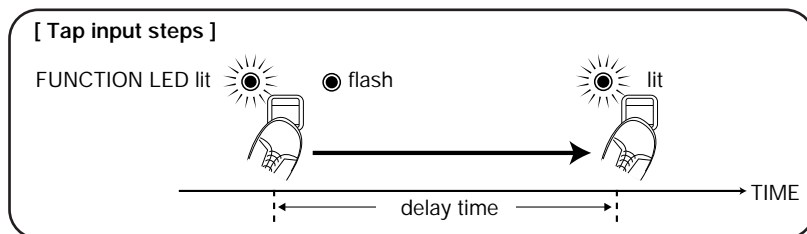

HINT When the FUNCTION switch mode is set to "3: DELAY (TAP&HOLD)", the FUNCTION LED flashes according to the delay time. This allows you to check the current setting when making tap input.

NOTE

- When the FUNCTION switch operation interval exceeds 2000 ms, the original delay time setting remains active.
- When the optional remote pedal RP01 is connected and the DELAY mode is selected, tap input can be carried out only with the pedal switch of the RP01. (For details, please refer to page 35.)

Using the FUNCTION switch

Using Hold Delay

When the FUNCTION Mode parameter is set to "3: DELAY (TAP&HOLD)" and the HOLD effect type is selected for the DELAY module, the hold delay function can be used. While you keep the FUNCTION switch depressed, play is sampled and then repeated by the 3000.

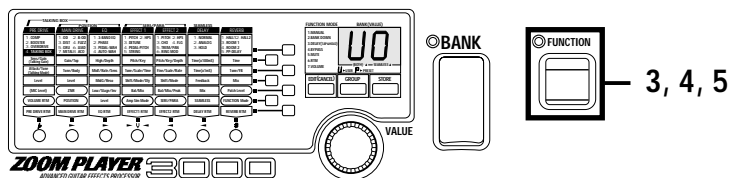

STEP 1 Set the FUNCTION Mode parameter to "3: DELAY (TAP&HOLD)", as described on page 18, 19.

STEP 2 Select the HOLD effect type of the DELAY module. If necessary, set the delay time parameter. This will be the longest interval that can be sampled.

The effect type setting can be checked in the Edit mode. For details, please refer to page 14.

HINT The maximum hold time interval is 2000 ms.

STEP 3 While playing your instrument, press the FUNCTION switch at the point where you want to start sampling.



STEP 4 Release the FUNCTION switch at the point where you want to end sampling.

The phrase is sampled for the length of the time that the FUNCTION switch is pressed. When the switch is released, the phrase is repeated.

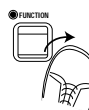

HINT When the FUNCTION switch mode is set to "3: DELAY (TAP&HOLD)", the FUNCTION LED flashes according to the delay time. This allows you to check the current setting when making tap input.

NOTE If the FUNCTION switch is pressed for a longer interval than the hold time, sampling ends before the switch is released, and repeat play starts.

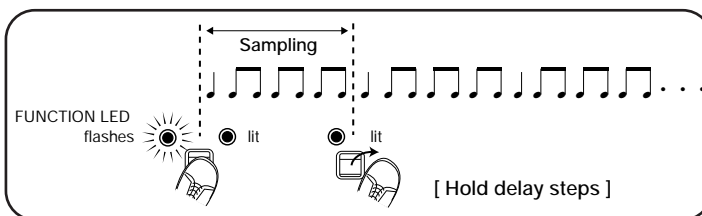

STEP 5 When wishing to stop the sampling function, press the FUNCTION switch once more.

When the FUNCTION switch is pressed, sampling stops and the FUNCTION LED flashes.



NOTE When the optional remote pedal RP01 is connected and DELAY mode is selected, hold delay can be carried out only with the pedal switch of the RP01. (For details, please refer to page 35.)

Adjusting Effect Parameters in Real Time (RTM)

The 3000 incorporates a so-called RTM (real-time modulation) function which lets the user change effect parameters in real time, using the FUNCTION switch. This makes it possible to adjust, for example, overdrive, distortion, or reverb mix during a performance. It is also possible to control several parameters simultaneously. The parameter(s) to be affected by RTM, the change distortion, and the change step width can be set for each patch individually.

To use the RTM function, perform the following steps.

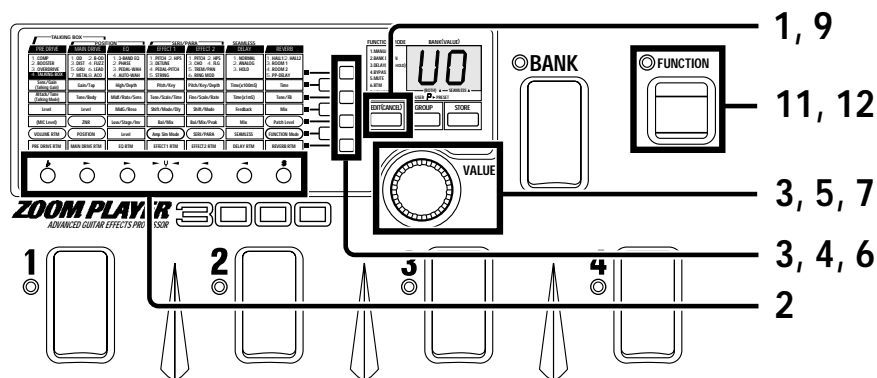

STEP 1 Press the EDIT key to activate the Edit mode.



STEP 2 Use the Module Select keys to select the module to be controlled by RTM.

If the module is off, press the Module Select key once more to turn it on.



STEP 3 Use the Parameter Select keys to select parameter 1, operate the VALUE knob and select the effect type.

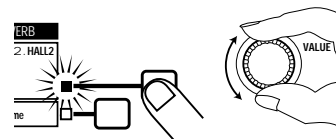

STEP 4 Refer to the section "Effect Types and Parameters" and check the control target parameter for the currently selected effect type. Then select this parameter with the Parameter Select keys.

Which parameter can be controlled depends on the effect type. In the "Effect Types and Parameters" table on page 36 - 45, the parameter marked with "←RTM" can be controlled by RTM.

For example, when the DELAY module is selected, parameter 5 (Mix ←RTM) can be controlled by RTM.



Using the FUNCTION switch

STEP 5 Use the VALUE knob to adjust the parameter.

The value set in this way becomes the reference setting for RTM.

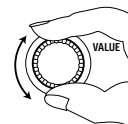

STEP 6 Use the Parameter Select keys to select parameter 7.

For every effect module and effect type, parameter 7 sets the RTM range.

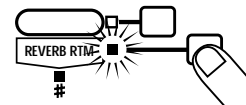

STEP 7 Use the VALUE knob to adjust the RTM parameter.

Normally, the RTM parameter uses the value set in step 5 as reference (0%) and allows adjustment over a range from -10 (-100%) to 0 (0%) to 10 (+100%). If the RTM control target parameter is negative when the FUNCTION switch is operated, the parameter is adjusted from the reference value towards negative values. If the target parameter is positive, it is adjusted from the reference value towards positive values.

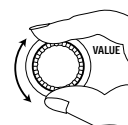

For example, if the "Mix (←RTM)" parameter was set to "50" in step 5, and the RTM parameter is "-5" (-50%), the adjustment range is 50 - 25. When the parameter is "+5", the adjustment range is 50 - 75.



- *The following case is an exception: When the EQ module is selected in step 2 and the effect type is set to PEDAL- WAH, or when the EFFECT1 module is selected and the effect type is set to PEDAL-PITCH (pedal pitch shifter), the RTM parameter setting range is "dn" (down) or "UP" only.*
- *It is possible to operate VOLUME RTM together with RTM. This is controlled by the VOLUME RTM "on" or "of" (off) setting in the PRE DRIVE effect module.*
- *The control target parameter cannot be changed beyond the parameter setting range. For example, if the control target parameter is already at maximum, setting the RTM parameter to a positive value has no effect.*

STEP 8 If desired, repeat steps 2 through 7 to make the RTM setting for other effect modules.

STEP 9 When the setting is completed, press the EDIT key to revert to Play mode.

If necessary, store the patch as described on page 17.



STEP 10 Set the FUNCTION switch mode to "6: RTM".

For details, please refer to the section "Using the FUNCTION switch" on page 18.

STEP 11 While playing your instrument, press and hold the FUNCTION switch

The RTM control target parameter changes gradually, causing a change in the sound quality of the patch. When the end point of the control range (maximum or minimum) is reached, the parameter remains constant also if the FUNCTION switch is still depressed.

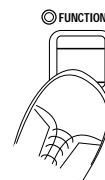

STEP 12 Release the FUNCTION switch.

The RTM control target parameter gradually returns to the original value.



You can release the FUNCTION switch already before the end of the control range is reached. The setting will gradually return to the original value.

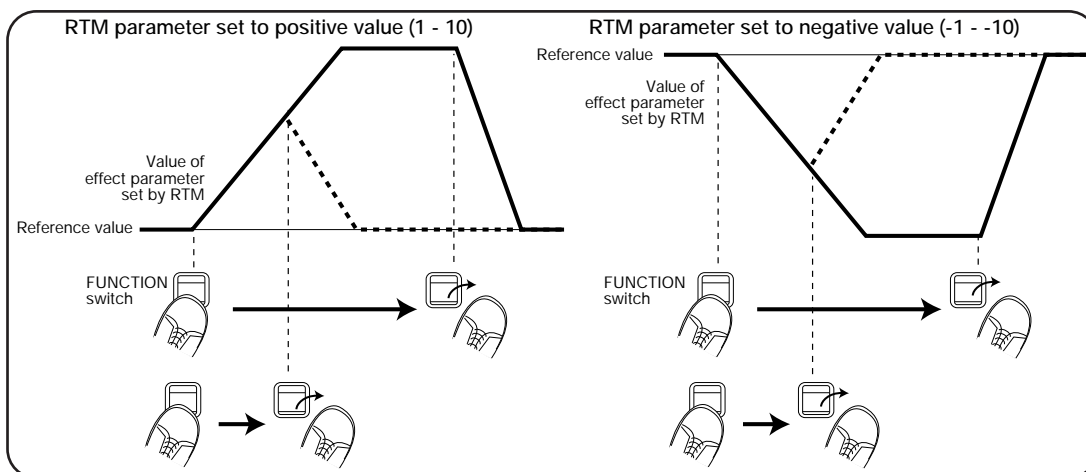
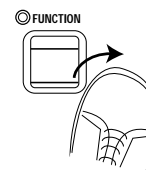

- When using RTM control for a distortion effect type of the PRE DRIVE or MAIN DRIVE module, and the RTM parameter is set to "dn", pressing the FUNCTION switch will cause the Gain (\leftarrow RTM) parameter to change gradually from the reference value towards the minimum value. When the RTM parameter is set to "UP", the change will be from the minimum value towards the reference value. The minimum value in this case depends on the effect type and Gain (\leftarrow RTM) parameter settings and may also be smaller than the Gain (\leftarrow RTM) parameter minimum value (1). This is due to the fact that the value is optimized internally by the 3000.
- When using RTM control for the PEDAL-WAH effect type of the EQ module, setting the RTM parameter to "dn" will cause a downward pitch shift and setting the parameter to "UP" will cause an upward pitch shift when the FUNCTION switch is pressed. In both cases, releasing the FUNCTION switch will cause the pitch to return gradually to normal.
- When using RTM control for the PEDAL-PITCH (pedal pitch shifter) effect type of the EFFECT 1 module, keeping the FUNCTION switch depressed will cause a gradual upward or downward shift. The direction is determined by the RTM parameter ("dn" or "UP").

Controlling the Volume in Real Time (VOLUME RTM)

VOLUME RTM is a function for controlling the input level to the EFFECT1 or EFFECT2 module using the FUNCTION switch. This makes it possible to easily perform fade-out or fade-in during a performance.

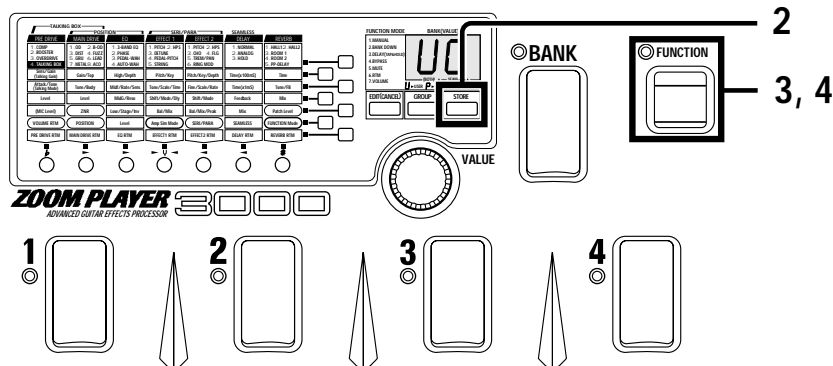

STEP 1 Set the FUNCTION switch mode to "7: VOLUME".

For details, please refer to the section "Using the FUNCTION switch" on page 18.



When the FUNCTION switch mode is set to "7: VOLUME", the FUNCTION switch always operates as volume control, regardless of the VOLUME RTM setting in the PRE DRIVE module.

STEP 2 Press the EDIT key to revert to Play mode.

If necessary, store the patch as described on page 17.



STEP 3 While playing your instrument, press and hold the FUNCTION switch.

The volume of the 3000 is gradually reduced to zero. While the FUNCTION switch is depressed, the FUNCTION LED lights.



The volume here refers to the input level of the EFFECT1 or EFFECT2 module, not the overall level of the 3000. If for example long delay with feedback is used, only the original sound is reduced, and the delay sound still is audible.



STEP 4 Release the FUNCTION switch.

The volume gradually returns to the original value.

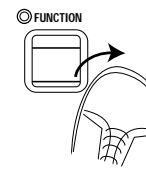

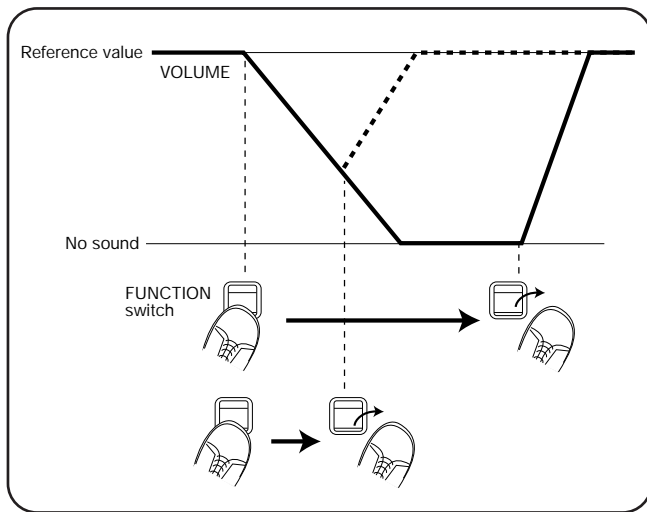

You can release the FUNCTION switch before the end of the control range is reached. The setting will gradually return to the original value.

Other Functions

Using the Amp Simulator

The 3000 incorporates an amp simulator that can be used for all patches. The amp simulator will produce realistic guitar amp sound also when monitoring with headphones or over an audio system.

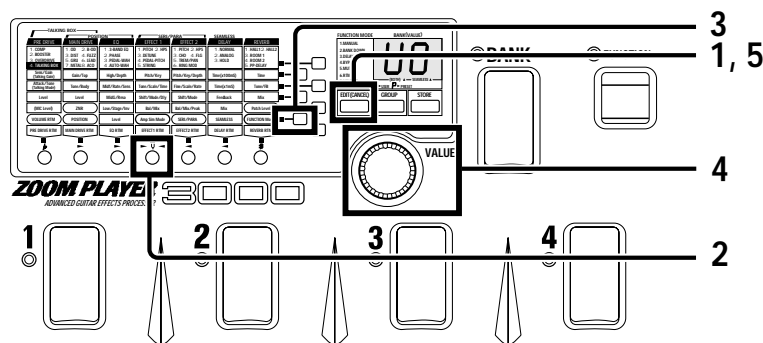

STEP 1 Press the EDIT key to activate the Edit mode.



STEP 2 Use the Module Select keys to select the EFFECT1 module.

The EFFECT1 module LED flashes.

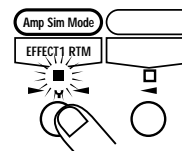

STEP 3 Use the Parameter Select keys to select "Amp Sim Mode".

This is a global parameter that serves for turning the amp simulator on or off and to select the mode.

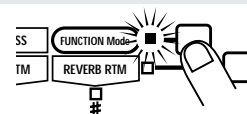

STEP 4 Use the VALUE knob to select the amp simulator mode as follows.

Values	Control	Assignment
oF	OFF	Amp simulator function is off.
C1- C9	COMBO	The amp simulator creates a sound resembling that of a combo amplifier of about 100 watts. Higher values result in stronger box sound.
b1- b9	BRIGHT COMBO	The amp simulator creates a sound resembling that of a bright combo amplifier of about 120 watts. Higher values result in stronger box sound.
S1- S9	STACK	The amp simulator creates a sound resembling that of a four-speaker amplifier stack. Higher values result in stronger box sound.

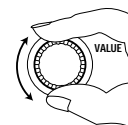

STEP 5 Press the EDIT key to revert to Play mode.



- Amp Sim Mode is a global parameter whose setting does not change when a different patch is selected. It can also be set when the EFFECT1 module is off.
- If not stored, the setting reverts to the previous value when the unit is turned off and then on again. When wishing to store the setting, select any patch in the USER group and store it as described on page 17.



Returning the 3000 to the Factory Default Settings (All Initialize/Factory Recall)

All Initialize is a special function for returning all the patches in the USER group and the values of the global parameters to their factory settings. Factory Recall allows selective return of a specified patch to the factory default.

NOTE Keep in mind that any patches you have stored will be erased if you implement the All Initialize function.

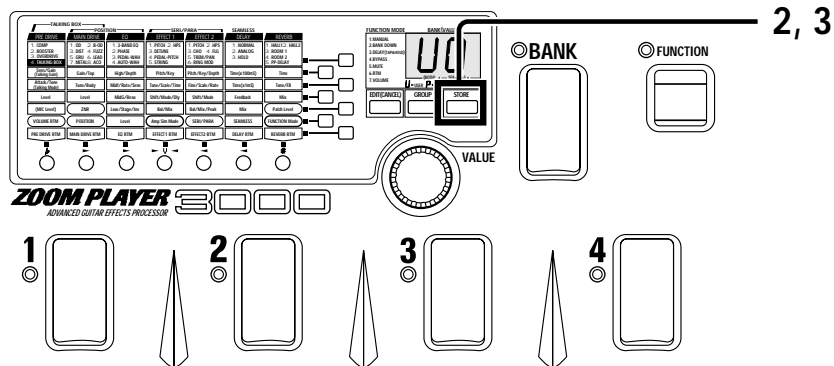

STEP 1 Cut the power supply to the 3000. (Be sure to turn the amplifier volume down to minimum.)

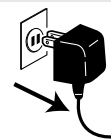

STEP 2 While holding the STORE key down, reinsert the AC adapter to power up the 3000.

The indication "AL" appears on the display and the module LED and parameter LED are flashing. This indicates that the unit is ready for the All Initialize function.

- To perform All Initialize:
Proceed to step 3.
 - To perform factory Recall:
Use the BANK switch and Foot Switches 1 - 4 to select the patch from the USER group which you want to return to the default condition.
- * When wishing to terminate the procedure, press the EDIT key. (The unit reverts to Play mode.)

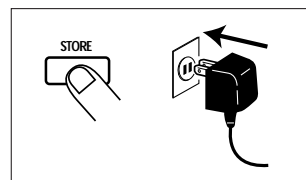

AL

STEP 3 Press the STORE key once more.

When All Initialize is being carried out, the module LED and parameter LED are flashing quickly. When initialization is completed, the unit automatically reverts to Play mode.

When Factory Recall is being carried out, the module LED and parameter LED are flashing quickly and the specified patch is restored. The unit then remains in standby mode for more patches. When wishing to terminate Factory Recall, press the EDIT key to return to Play mode.



Using the Talking Box Effect

The TALKING BOX effect is an effect type included in the PRE DRIVE effect module. It changes the sound of a guitar into sound resembling a human voice. The optional headset microphone HM01 or another dynamic microphone can be used to change the guitar sound according to your own voice input.

Connecting the Microphone

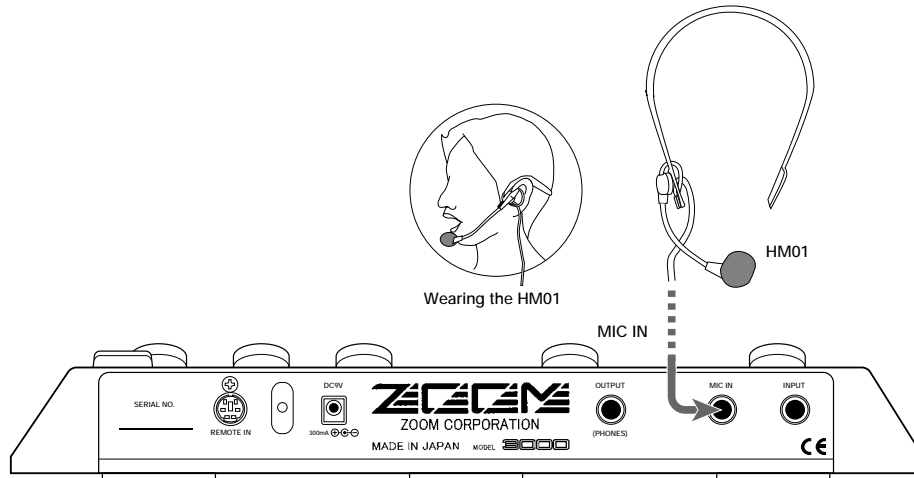

Using the Microphone to Control the Talking Box Effect

This section explains how to use the microphone to control the TALKING BOX effect.

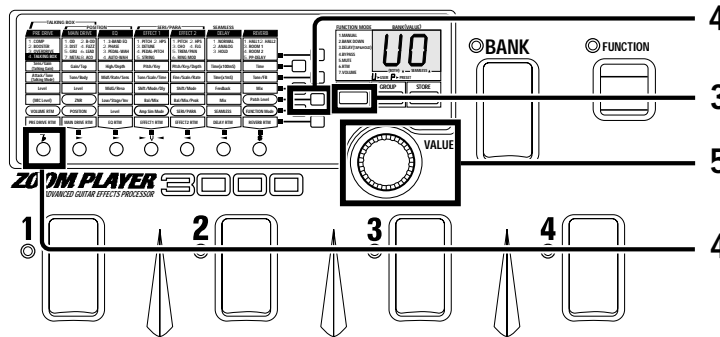

STEP 1 Verify that the microphone is properly connected to the MIC IN jack on the 3000.

STEP 2 Select a patch which uses the TALKING BOX effect of the PRE DRIVE module.

To check the effect type, use the Edit mode. For details, please refer to page 14.

STEP 3 Press the EDIT key to enter Edit mode



STEP 4 In Edit mode, press the PRE DRIVE module key and the parameter 5 key to call up the MIC Level parameter.

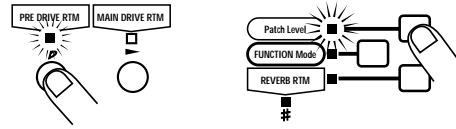

STEP 5 Use the VALUE knob to adjust the MIC Level parameter.

This parameter controls the input level from the MIC IN jack. Talk into the microphone while playing your instrument to find the optimum position.

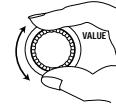

HINT You may also try to adjust the Talking Gain (distortion amount) and Talking Mode (effect variation) parameters.

STEP 6 To return to the Play mode, press the EDIT key.

For information on how to store the parameter settings, please refer to page 17.



STEP 7 Play your instrument while talking into the microphone.

The guitar sound changes according to the mic input.

HINT The TALKING BOX effect can be used also without a microphone.

NOTE When the TALKING BOX effect type is selected for the PRE DRIVE effect module, the MAIN DRIVE effect module cannot be used.

Using the Remote Pedal

The optional remote pedal RP01 allows use of its foot switch in place of the FUNCTION switch on the 3000. The RP01 has two modes, which serve for different functions.

- **RTM mode**

The remote pedal RP01 serves for continuously varying the RTM control target for a patch or the VOLUME RTM. This allows use for pedal wah or the pedal pitch shifter. It is also possible to use the FUNCTION switch on the 3000 for volume control and the RP01 for RTM control.

- **DELAY mode**

This mode allows use of the switch on the RP01 for delay time tap input and hold delay operation. It is also possible to use the FUNCTION switch on the 3000 for RTM and the RP01 for tap input.

RP01 Names of Parts / Connections

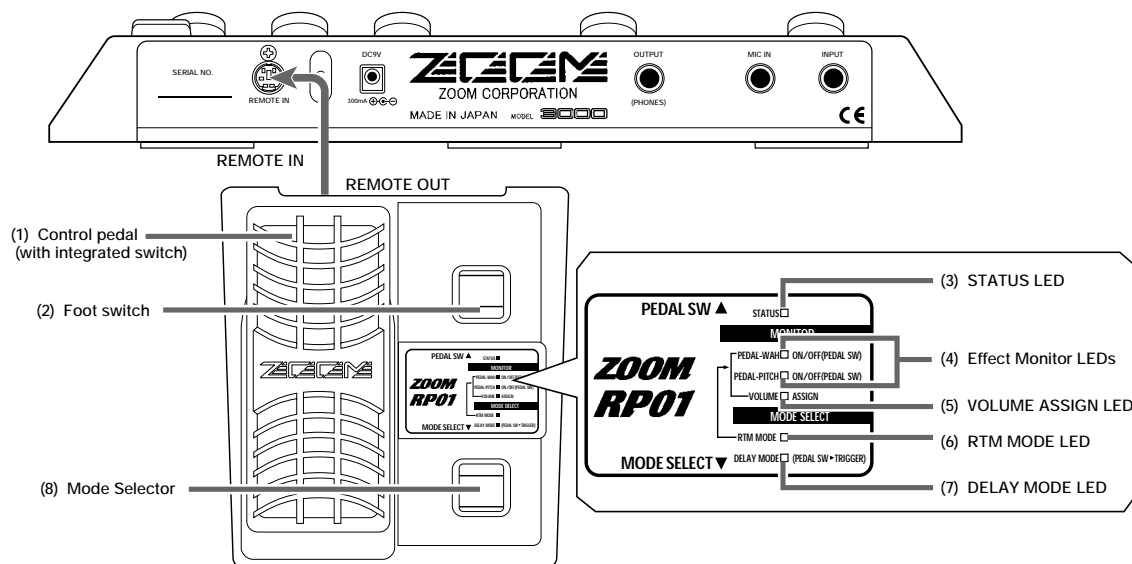

(1) **Control pedal (with integrated switch)**

Serves to control the RTM target parameter or VOLUME RTM etc. By depressing the pedal fully in RTM mode, pedal wah or pedal pitch shifter can be turned on or off with an integrated switch.

(2) **Foot switch**

Can be used for on/off switching of pedal wah or pedal pitch shifter, and for delay time tap input and other functions.

(3) **STATUS LED**

Shows the operation status of the RP01.

(4) **Effect Monitor LEDs**

Indicate the on/off condition of the pedal wah and pedal pitch shifter functions.

(5) **VOLUME ASSIGN LED**

Indicates the on/off condition of the VOLUME RTM function (When lit, the RP01 can be used to control the volume.)

(6) **RTM MODE LED**

Lights up when the RP01 is in RTM mode.

(7) **DELAY MODE LED**

Shows the on/off state of the DELAY module of the 3000 when the RP01 is in DELAY mode.

(8) **Mode Selector**

Serves to switch between RTM mode and DELAY mode.

Using the RP01 for Controlling the RTM Target Parameter (RTM Mode)

This section describes how to use the RP01 for controlling the RTM parameter set for the patch.

STEP 1 Verify that the RP01 is properly connected to the 3000.

NOTE Before connecting the RP01, make sure that the 3000 is turned off. Connecting the pedal while the 3000 is on can lead to malfunction.

STEP 2 Set the FUNCTION switch to one of modes 1 - 5.

For details, please refer to the section "Using the FUNCTION switch" on page 18.

NOTE If the FUNCTION switch is set to mode 6 or 7, the function of the RP01 will be different. Please refer to page 34.

STEP 3 Call up a patch for which RTM has been set.

For information on making settings for the RTM function, please refer to page 23.

NOTE Whenever a new patch is called up, the RP01 will be in RTM mode.

MODE SELECT

— RTM MODE

DELAY MODE (PEDAL SW → TRIGGER)

RTM LED of RP01 lights up

STEP 4 Operate the Control pedal of the RP01 while playing your instrument.

- As opposed to using the FUNCTION switch on the 3000, the Control pedal allows continuous variation of the RTM control target parameter in both directions, and the value can also be fixed to a desired point.

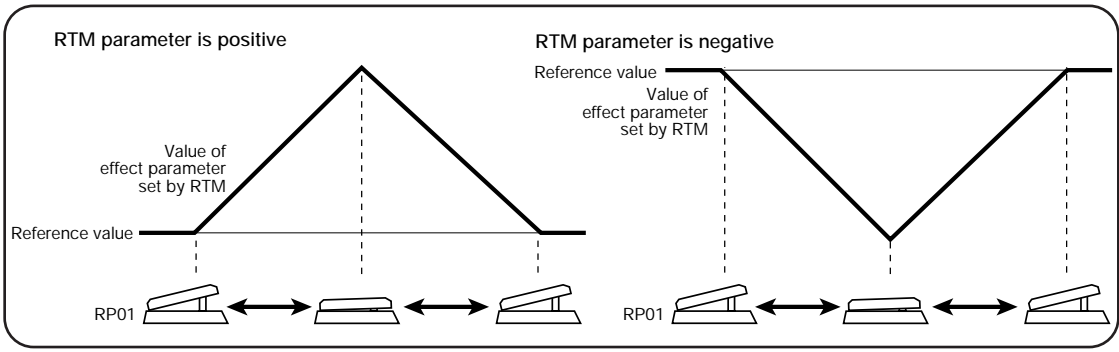
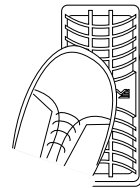

Using the Remote Pedal

- When PEDAL-WAH (EQ module) or PEDAL-PITCH (EFFECT1 module) is selected as effect type for the current patch, the Control pedal of the RP01 can also be used for pedal wah or the pedal pitch shifter.

The on/off status for pedal wah or pedal pitch shifter can be verified with the Effect Monitor LED.

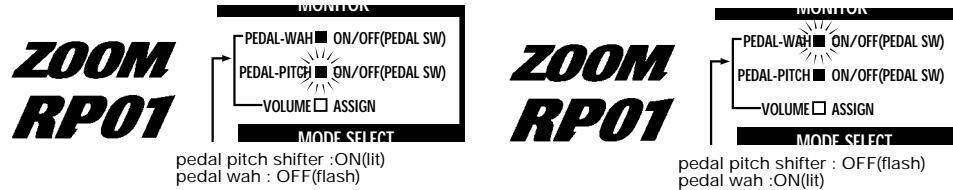

- To switch pedal wah or pedal pitch shifter on or off, use the switch integrated in the Control pedal or the separate foot switch.

HINT The switch integrated in the Control pedal will be suitable when wishing to operate the pedal continuously. The separate foot switch is useful for switching the function on or off while the pedal is only partially depressed.

- If the VOLUME RTM setting is on for the called patch, the Control pedal can be used to control the VOLUME RTM action.

In this case, the VOLUME Assign LED lights up.

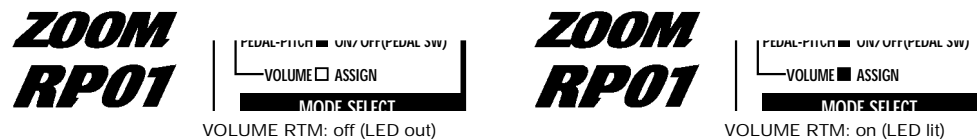

NOTE

- If the Effect Monitor LEDs are out, this means that the effect type PEDAL-WAH or PEDAL-PITCH is not selected for the current module. In this case, operating the switch integrated in the Control pedal or the separate foot switch has no effect.
- Changes to the RTM parameter are temporary. When a new patch is called up, the settings for that patch become active.

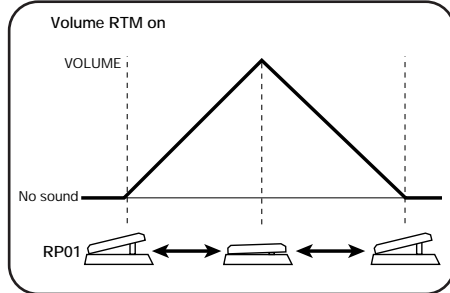

HINT When the FUNCTION switch mode is set to 6 or 7, the FUNCTION switch and the control pedal RP01 can be assigned to different functions.

FUNCTION switch mode	RP01 not connected		RP01 connected	
	FUNCTION switch operation (3000)	FUNCTION switch operation (3000)	FUNCTION switch operation (3000)	Control pedal operation (RP01)
6: RTM mode	RTM including VOLUME RTM (VOLUME RTM setting valid)	RTM except VOLUME RTM (VOLUME RTM setting invalid)	RTM except VOLUME RTM (VOLUME RTM setting invalid)	Overall VOLUME RTM (VOLUME RTM setting is invalid)
7: VOLUME mode	Overall output level of 3000	Overall VOLUME RTM (VOLUME RTM setting is invalid)	Overall VOLUME RTM (VOLUME RTM setting is invalid)	RTM except VOLUME RTM (VOLUME RTM setting invalid)

NOTE When the FUNCTION switch mode of the 3000 is set to 6 (RTM), the foot switch of the RP01 (or the switch integrated in the Control pedal) cannot be used to switch pedal wah or pedal pitch shifter on and off.

Using the RP01 for Delay Tap Input or Hold Delay Operation (DELAY Mode)

This section describes how to use the RP01 for operating the DELAY mode.

STEP 1 Verify that the RP01 is properly connected to the 3000.

NOTE Before connecting the RP01, make sure that the 3000 is turned off. Connecting the pedal while the 3000 is on can lead to malfunction.

STEP 2 Select a patch for which the DELAY effect module is on.

- When the selected patch uses the NORMAL or ANALOG effect type, tap input of delay time is possible.
- When the selected patch uses the HOLD effect type, hold delay operation is possible.

STEP 3 Push the Mode Selector of the RP01 to select DELAY mode.

DELAY MODE LED lights up when the DELAY module of the 3000 is on and flashes when it is off.

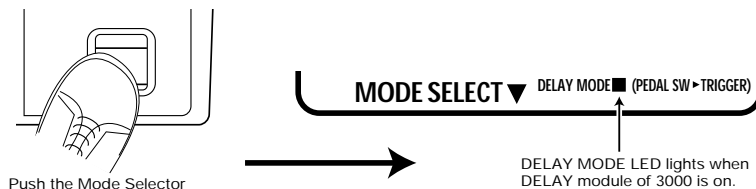

STEP 4 Use the foot switch on the RP01 to perform tap input of the delay time, or perform hold delay operation.

- Operation is the same as when using the FUNCTION switch on the 3000. The STATUS LED serves as function LED. For details, please refer to "Setting Delay Time With Foot Switch" on page 21 or "Using Hold Delay" on page 22.

NOTE

- When the RP01 is connected and DELAY mode is selected, delay time tap input or hold delay operation cannot be carried out with the FUNCTION switch on the 3000, also if the FUNCTION switch mode is set to "3: DELAY (TAP&HOLD)".
- * When the RP01 is in DELAY mode, the Control pedal can be used to adjust the balance between delay sound and original sound. The integrated switch can be used to turn delay on and off.

STEP 5 To return to the RTM mode, press the Mode Selector once more.

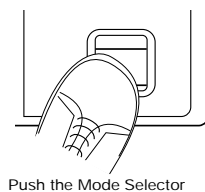

Effect Types and Parameters

This section explains all the Zoom Player 3000's effect types and parameters. However, parameters that are the same for other effect types are only explained in brief.

- Parameters marked with "G" are global parameters, and parameters marked with "P" are patch parameters. These parameters can be changed regardless of the on/off condition of the respective effect module.
- Parameters marked with "←RTM" are parameters which can be operated by RTM when that effect module is selected.

NOTE Depending on the type selected for the effect module, some parameters have no setting item (shaded section in the illustration). For information on the display of such parameters, please refer to page 14.

PRE DRIVE

This module comprises distortion effects such as compressor and overdrive. The talking box effect for use with a microphone and the VOLUME RTM setting are also part of this module.

Parameter 1 TYPE	1. COMP	2. BOOSTER	3. OVERDRIVE	4. TALKING BOX
Parameter 2	Sens (←RTM) 1 ~ 10	Gain (←RTM) 1 ~ 16		Talking Gain (←RTM) 1 ~ 16
Parameter 3	Attack 0 ~ 10	Tone 0 ~ 10		Talking Mode M1, M2, G1, G2
Parameter 4	Level 1 ~ 30			
Parameter 5				MIC Level 1 ~ 10
Parameter 6	VOLUME RTM (P) oF, on			
Parameter 7	PRE DRIVE RTM - 10 ~ + 10	PRE DRIVE RTM oF, dn, UP		

■ Parameter 1 TYPE (Effect Type)

The following four effect types can be selected for the PRE DRIVE effect module.

Type 1 COMP (Compressor)

Type 2 BOOSTER

Type 3 OVERDRIVE

Type 4 TALKING BOX

Depending on the selected effect type, the content of parameters 2, 3, 5, 7 changes.

■ Type 1 COMP (Compressor)

This effect keeps the level constant, resulting in a steady and stable sound.

●Parameter 2 Sens (←RTM)

Determines the depth of the compression effect.

●Parameter 3 Attack

Determines the time interval between guitar attack sound and the start of compression.

■ Type 2 BOOSTER

Booster effect with emphasis on mid and upper range.

●Parameter 2 Gain (←RTM)

Determines the distortion intensity.

●Parameter 3 Tone

Adjusts the high-frequency range sound.

■ Type 3 OVERDRIVE

Overdrive effect giving the kind of distortion produced by a tube amplifier. The parameters are the same as for BOOSTER of type 2.

■ Type 4 TALKING BOX

When this effect type is selected and you speak into a microphone connected to the MIC IN jack, the signal from the microphone influences the sound of the guitar you are playing. Even if no microphone is connected, this effect yields an interesting sound. When this effect type is selected, the MAIN DRIVE effect module cannot be used.

●Parameter 2 Talking Gain (←RTM)

Determines the amount of distortion.

●Parameter 3 Talking Mode

Selects an effect variation.

The M1 and M2 variation can be controlled with the optional headset microphone HM01 or another dynamic microphone.

M1 : Mild sound (with microphone input)

M2 : Wide-range effect (with microphone input)

G1 : Mild sound (with guitar input)

G2 : Wide-range effect (with guitar input)

●Parameter 5 MIC Level

M1, M2: Determines the MIC IN jack input level.

G1, G2 : Determines the guitar jack input sensitivity.

■ Common parameters for type 1 - 4

●Parameter 4 Level

Determines the module output level.

●Parameter 6 VOLUME RTM (P)

This patch parameter determines whether the patch volume is controlled in RTM. When set to on, the FUNCTION switch or optional remote pedal RP01 can be used to control the input level to the EFFECT1 or EFFECT2 module. For details, please refer to page 23 and 33.

●Parameter 7 PRE DRIVE RTM

Determines the change direction and control range for the parameter marked with "RTM". When set to a positive value, the value of the control target parameter increases when the FUNCTION switch or remote pedal RP01 is operated. When set to a negative value, the value decreases. The current setting of the control target parameter is used as a reference point, and the range extends from -10 (-100%) to +10 (+100%). For distortion effect types, this becomes the setting value of "oF", "UP", and "dn". For details, please refer to the note on page 25.

MAIN DRIVE

This module contains mainly distortion type effects. It also comprises the ZNR settings (patch parameter) and the connection type settings for the MAIN DRIVE and EQ modules (patch parameter).

Parameter 1 TYPE	1. OD	2. B-OD	3. DIST	4. FUZZ	5. GRU	6. LEAD	7. METAL	8. ACO
Parameter 2	Gain (RTM) 1 ~ 30							Top 1 ~ 10
Parameter 3	Tone 0 ~ 10							Body 1 ~ 10
Parameter 4	Level 1 ~ 30							Level (RTM) 1 ~ 30
Parameter 5	ZNR (P) oF, 1 ~ 7							
Parameter 6	POSITION (P) ME, EM, Pr							
Parameter 7	MAIN DRIVE RTM oF, dn, UP							MAIN DRIVE RTM - 10 ~ + 10

■ Parameter 1 TYPE (Effect Type)

The following eight effect types can be selected for the MAIN DRIVE effect module.

Type 1 OD (Overdrive)

Type 2 B-OD (Blues Overdrive)

Type 3 DIST (Distortion)

Type 4 FUZZ

Type 5 GRU (Grunge)

Type 6 LEAD

Type 7 METAL

Type 8 ACO (Acoustic)

Depending on the selected effect type, the content of parameters 2, 3, 4 and 7 changes.

■ Type 1 OD (Overdrive)

Tube-amp type overdrive distortion. This is a variation of the PRE DRIVE overdrive distortion.

● Parameter 2 Gain (←RTM)

Determines the amount of distortion.

● Parameter 3 Tone

Adjusts the tonal quality. Higher values result in brighter sound.

■ Type 2 B-OD (Blues Overdrive)

Solid overdrive best suited for blues numbers. The parameter content is the same as for type 1 (OD).

■ Type 3 DIST (Distortion)

Large amplifier type distortion. The parameter content is the same as for type 1 (OD).

■ Type 4 FUZZ

Vintage fuzz essential for the rock style of the sixties. The parameter content is the same as for type 1 (OD).

■ Type 5 GRU

Modern fuzz with a stimulating sound. The parameter content is the same as for type 1 (OD).

■ Type 6 LEAD

Clear, distinct sound optimally suited for lead guitar. The parameter content is the same as for type 1 (OD).

■ Type 7 METAL

Heavy metal type sound with a prominent treble and bass. The parameter content is the same as for type 1 (OD).

■ Type 8 ACO (Acoustic)

Acoustic guitar simulator which changes the sound of an electric guitar into an acoustic guitar sound.

● Parameter 2 Top

Adjusts the high-frequency range. Higher values stress the characteristic string sound of an acoustic guitar.

● Parameter 3 Body

Adjusts the low-frequency range. Higher values result in a more pronounced body sound.

■ Common parameters for type 1 - 8

● Parameter 4 Level (←RTM)

Determines the module output level.

● Parameter 5 ZNR (P)

This patch parameter controls the sensitivity of the ZNR (Zoom Noise Reduction) circuit. The recommended approach is to set the value as high as possible without producing an unnatural cut of the instrument sound. When set to "oF", ZNR is disabled.

● Parameter 6 POSITION (P)

This patch parameter determines the connection method of the MAIN DRIVE module and EQ module. "ME" (MAIN DRIVE → EQ), "EM" (EQ →MAIN DRIVE), and "Pr" (parallel) can be selected.

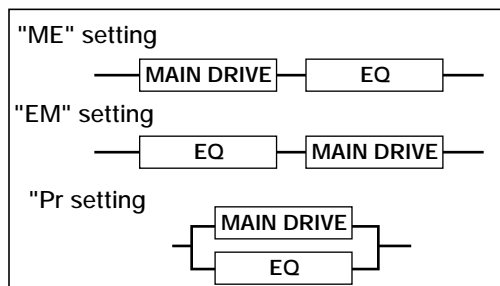

NOTE When the TALKING BOX effect of the PRE DRIVE module is selected, the signal is directly sent to the EQ module. The POSITION parameter can therefore not be set. (Refer to the illustration at the bottom of page 4.)

● Parameter 7 MAIN DRIVE RTM

Determines the change direction and control range for the parameter marked with "←RTM".

This effect module comprises a 3-band equalizer, phaser, and wah effects.

Parameter 1 TYPE	1. 3-BAND EQ	2. PHASE	3. PEDAL-WAH	4. AUTO-WAH
Parameter 2	High - 12 ~ + 12	Depth 0 ~ 10	High - 12 ~ + 12	Depth 1 ~ 10
Parameter 3	Midf 0.2/0.4/0.8/1.2/2.0/3.1/5.6/8.0	Rate(RTM) 1 ~ 50	f 1 ~ 50	Sens(RTM) 1 ~ 10
Parameter 4	MidG - 12 ~ + 12	Reso 0 ~ 10		Reso 1 ~ 3
Parameter 5	Low - 12 ~ + 12	Stage 4, 8	Low - 12 ~ + 12	Inv dn, UP
Parameter 6	Leve(RTM) 1 ~ 30	Level 1 ~ 30		
Parameter 7	EQ RTM - 10 ~ + 10		EQ RTM oF, dn, UP	EQ RTM - 10 ~ + 10

■ Parameter 1 TYPE (Effect Type)

The following four effect types can be selected for the EQ effect module.

- Type 1 3-BAND EQ
- Type 2 PHASE (Phaser)
- Type 3 PEDAL-WAH
- Type 4 AUTO-WAH

Depending on the selected effect type, the content of parameters 2 - 7 changes.

■ Type 1 3-BAND EQ

This 3-band equalizer allows adjusting the high-frequency range, mid-frequency range, and low-frequency range.

- **Parameter 2 High**
Controls boost/cut for the high-frequency range.
- **Parameter 3 Midf**
The midrange frequency can be selected from the following values: 0.2 (250 Hz), 0.4 (400 Hz), 0.8 (800 Hz), 1.2 (1.25 kHz), 2.0 (2 kHz), 3.1 (3.15 kHz), 5.6 (5.6 kHz), 8.0 (8 kHz).
- **Parameter 4 MidG**
Determines boost/cut for the mid-frequency range.
- **Parameter 5 Low**
Controls boost/cut for the low-frequency range.
- **Parameter 6 Level (←RTM)**
Determines the module output level.
A setting of "25" yields flat response.
- **Parameter 7 EQ RTM**
Determines the change direction and control range for the parameter marked with "←RTM".

■ Type 2 PHASE (Phaser)

Adds a phase-shifted effect component to the direct sound, creating a special undulating sound.

- **Parameter 2 Depth**
Determines the depth of the phaser effect.
- **Parameter 3 Rate (←RTM)**
Determines the speed of the phaser effect.
- **Parameter 4 Reso**
Determines the resonance component of the phaser effect.
- **Parameter 5 Stage**
Determines the number of stages for the phaser effect. When set to "8", a detailed phaser effect is achieved.
- **Parameter 6 Level**
- **Parameter 7 EQ RTM**

■ Type 3 PEDAL-WAH

This effect type allows use of the optional remote pedal RP01 or the FUNCTION switch of the 3000 for pedal wah.

- **Parameter 2 High**
Controls boost/cut for the high-frequency range.
- **Parameter 3 f**
Determines the initial frequency (when pedal is not operated).
- **Parameter 5 Low**
Controls boost/cut for the low-frequency range.
- **Parameter 6 Level**
- **Parameter 7 EQ RTM**
Determines the direction in which the wah effect changes when the pedal is pressed. "dn" means a downward change and "UP" an upward change.

■ Type 4 AUTO-WAH

This effect type creates an automatic wah effect that depends on the picking intensity.

- **Parameter 2 Depth**
Determines the depth of the auto-wah effect.
- **Parameter 3 Sens (←RTM)**
Determines the sensitivity of the auto-wah effect.
- **Parameter 4 Reso**
Adds a special touch to the auto-wah effect.

● Parameter 5 Inv

Determines the direction of change for the auto-wah effect. "dn" means a downward change and "UP" an upward change of the emphasized frequency.

- **Parameter 6 Level**
- **Parameter 7 EQ RTM**
Determines the change direction and control range for the parameter marked with "←RTM".

EFFECT1

This module contains mainly pitch shift type effects. The amp simulator (global parameter) settings are also part of this module.

Parameter 1 TYPE	1. PITCH	2. HPS	3. DETUNE	4. PEDAL-PITCH	5. STRING
Parameter 2	Pitch 0, 1, 2, ...11, 12, 24	Key C, C#, ...A#, b	Pitch - 12 ~ + 12		Pitch 0, 1, 2, ...11, 12, 24
Parameter 3	Tone 0 ~ 10	Scale M3, m3, 4t, 5t, 6t	Tone 0 ~ 10		Time 0 ~ 99
Parameter 4	Shift dn, UP		Dly 0 ~ 50	Mode 1 ~ 8	Shift dn, UP
Parameter 5	Bal (RTM) 0 ~ 99, 1.0	Mix (RTM) 0 ~ 99, 1.0	Bal (RTM) 0 ~ 99, 1.0		Bal (RTM) 0 ~ 99, 1.0
Parameter 6	Amp Sim Mode (G) oF, C1 ~ C9, b1 ~ b9, S1 ~ S9				
Parameter 7	EFFECT1 RTM - 10 ~ + 10		EFFECT1 RTM dn, UP	EFFECT1 RTM - 10 ~ + 10	

■ Parameter 1 TYPE (Effect Type)

The following five effect types can be selected for the EFFECT1 effect module.

- Type 1 PITCH (Pitch Shifter)
- Type 2 HPS (Harmonized Pitch Shifter)
- Type 3 DETUNE
- Type 4 PEDAL-PITCH (Pedal Pitch Shifter)
- Type 5 STRING (Strings)

Depending on the selected effect type, the content of parameters 2 - 5 and 7 changes.

■ Type 1 PITCH (Pitch Shifter)

Allows to shift the pitch over a range of 2 octaves up or down.

- **Parameter 2 Pitch**
Determines the amount of pitch shift in semitones.
- **Parameter 3 Tone**
Adjusts the high-frequency range of the effect. Lower values result in a softer sound with less treble.

● Parameter 4 Shift

Determines the direction of pitch shift. "dn" means a downward change and "UP" an upward change.

● Parameter 5 Bal (←RTM)

Determines the level balance between effect sound and original sound. "0" means original sound only, and "1.0" (100) means effect sound only.

● Parameter 7 EFFECT1 RTM

Determines the change direction and control range for the parameter marked with "←RTM".

■ Type 2 HPS (Harmonized Pitch Shifter)

Pitch shifter which creates harmonies using a preset key and scale.

● Parameter 2 Key

Determines the main key for the scale (C, C#, d, d#, E, F, F#, g, g#, A, A#, b).

● Parameter 3 Scale

Determines the scale of the harmony.
M3 = Major 3rd, m3 = minor 3rd, 4t = 4th, 5t = 5th, 6t = 6th

● **Parameter 4 Shift**

● **Parameter 5 Mix (←RTM)**

Determines the mixing balance between effect sound and original sound.

● **Parameter 7 EFFECT1 RTM**

 *When using this effect type, you should play single notes.*

■ **Type 3 DETUNE**

This effect type uses a creative mix of pitch-shifted effect sound and original sound to achieve a chorus sound with only slight modulation.

● **Parameter 2 Pitch**

Determines the pitch detune amount.

● **Parameter 3 Tone**

Adjusts the high-frequency range of the effect. Higher values result in a softer sound with less treble.

● **Parameter 4 Dly**

Determines the delay time of the effect.

● **Parameter 5 Bal (←RTM)**

Determines the level balance between effect sound and original sound. "0" means original sound only, and "1.0" (100) means effect sound only.

● **Parameter 7 EFFECT1 RTM**

■ **Type 4 PEDAL-PITCH (Pedal Pitch Shifter)**

This effect type is designed for use with the optional remote pedal RP01 or the FUNCTION switch of the 3000.

● **Parameter 3 Tone**

● **Parameter 4 Mode**

The following eight modes can be selected for the pitch shift method.

When RTM parameter is "UP"	Pedal down	Pedal up
When RTM parameter is "dn"	Pedal up	Pedal down
Mode		
1: Dirty Bend	-100 cent	DRY
2: Detune	DOUBLING	-30 cent + DRY
3: Bend Up	0 cent	+1 oct
4: Arm Down	0 cent	-2 oct
5: Octave Harmony	-1 oct + DRY	+1 oct + DRY
6: -5th/+4th	-700 cent + DRY	+500 cent + DRY
7: Cross-Fade	-<infinite> + DRY	+1 oct
8: Stop	-<infinite> + DRY	+1 oct + DRY

● **Parameter 7 EFFECT1 RTM**

When a patch is called or the effect type is switched and the pedal pitch shifter is selected, the pedal up condition corresponds to the default value.

■ **Type 5 STRING (Strings)**

This effect type combines a pitch shifter and slow attack for automatic "violin playing" sound.

● **Parameter 2 Pitch**

Determines the amount of pitch shift in semitones.

● **Parameter 3 Time**

Determines the time until the onset of the effect.

● **Parameter 4 Shift**

Determines the direction of pitch shift. "dn" means a downward change and "UP" an upward change.

● **Parameter 5 Bal (←RTM)**

Determines the level balance between pitch shifted sound with delayed attack and original sound.

● **Parameter 7 EFFECT1 RTM**

Determines the change direction and control range for the parameter marked with "←RTM".

■ **Common parameters for type 1 - 5**

● **Parameter 6 Amp Sim Mode (G)**

This is a global parameter which determines the sound character of the amp simulator. For details, please refer to "Using the Amp Simulator" on page 28.

EFFECT2

This effect module comprises modulation effects such as chorus, flanger, tremolo, etc. The connection method of the EFFECT1 module and EFFECT2 module (serial or parallel) is also determined in this module.

Parameter 1 TYPE	1. PITCH	2. HPS	3. CHO	4. FLG	5. TREM/PAN	6. RING MOD
Parameter 2	Pitch 0, 1, 2, ... 11, 12, 24	Key C, C#, ... A#, b	Depth 0 ~ 10			Depth (Time) 0 ~ 10
Parameter 3	Fine - 10 ~ oF ~ + 10	Scale M3, m3, 4t, 5t, 6t	Rate 1 ~ 50	Rate (RTM) 1 ~ 50		
Parameter 4	Shift dn, UP		Mode M1, M2, S1, S2	Mode 1 ~ 10	Mode (DEPTH) 0 ~ 10	Mode(Reso) 0 ~ 10
Parameter 5	Bal (RTM) 0 ~ 99, 1.0	Mix (RTM) 0 ~ 99, 1.0		Peak (FB) 0 ~ 10	Peak (CLIP) 0 ~ 10	Mix 0 ~ 99, 1.0
Parameter 6	SERI/PARA (P) Sr, P1 ~ P9					
Parameter 7	EFFECT2 RTM - 10 ~ + 10					

Parameter 1 TYPE (Effect Type)

The following six effect types can be selected for the EFFECT2 module.

- Type 1 PITCH (Pitch Shifter)
- Type 2 HPS (Harmonized Pitch Shifter)
- Type 3 CHO (Chorus)
- Type 4 FLG (Flanger)
- Type 5 TREM/PAN (Tremolo/Auto Panpot)
- Type 6 RING MOD (Ring Modulator)

Depending on the selected effect type, the content of parameters 2 - 5 changes.

Type 1 PITCH (Pitch Shifter)

Allows to shift the pitch over a range of 2 octaves up or down.

- **Parameter 2 Pitch**
Determines the amount of pitch shift in semitones.
- **Parameter 3 Fine**
Allows fine-adjusting of pitch shift amount.
- **Parameter 4 Shift**
Determines the direction of pitch shift. "dn" means a downward change and "UP" an upward change.
- **Parameter 5 Bal (←RTM)**
Determines the level balance between effect sound and original sound. "0" means original sound only, and "1.0" (100) means effect sound only.

Type 2 HPS (Harmonized Pitch Shifter)

Pitch shifter which creates harmonies using a preset

key and scale. By using this effect together with the HPS of the EFFECT1 module, a three-part harmony can be created. The parameter content is the same as for HPS in the EFFECT1 module.



When using this effect type, you should play single notes.

Type 3 CHO (Chorus)

This is a chorus effect which achieves an expansive, warm sound.

- **Parameter 2 Depth**
Determines the depth of the effect.
- **Parameter 3 Rate**
Determines the modulation rate.
- **Parameter 4 Mode**
Determines the chorus effect variation.
M1, M2 = mono chorus variation
S1, S2 = stereo chorus variation
- **Parameter 5 Mix (←RTM)**

Type 4 FLG (Flanger)

This is a flanger effect which creates a surging jet sound.

- **Parameter 2 Depth**
- **Parameter 3 Rate (←RTM)**
Determines the rate of the flanger effect.
- **Parameter 4 Mode (PreDLY)**
Determines the delay time of the flanger effect.
- **Parameter 5 Peak (FB)**
Adjusts the wave characteristic of the flanger effect.

■ Type 5 TREM/PAN (Tremolo/Auto Panpot)

This effect type combines a tremolo effect with an automatic panpot that shifts the sound between left and right.

●Parameter 2 Depth

Determines the depth of the tremolo effect.

●Parameter 3 Rate (←RTM)

Determines the rate of the tremolo effect.

●Parameter 4 Mode (DEPTH)

Determines the depth of the auto panpot.

●Parameter 5 Peak (CLIP)

Varies the modulation waveform. Higher values result in stronger clipping of the waveform, which emphasizes the tremolo effect.

■ Type 6 RING MOD (Ring Modulator)

This is a ring modulator which produces a metallic sound.

●Parameter 2 Depth (Time)

Determines the delay time of the effect sound.

●Parameter 3 Rate (←RTM)

Determines the modulation frequency.

●Parameter 4 Mode (Reso)

Determines the resonance of the ring modulator.

●Parameter 5 Mix

Determines the level balance between effect sound and original sound. "0" means original sound only, and "1.0" (100) means effect sound only.

■ Common parameters for type 1 - 6

●Parameter 6 SERI/PARA (P)

This patch parameter determines the connection method of the EFFECT1 and EFFECT2 modules. The following settings are available.

- Sr: EFFECT1 and EFFECT2 are connected in series.
- P1 - P9: EFFECT1 and EFFECT2 are connected in parallel. The value at right adjusts the level balance of EFFECT1 and EFFECT2 (P1 results in a high level for EFFECT1 and P9 in a high level for EFFECT2).

"Sr" setting

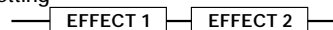

"P1" - "P9" setting

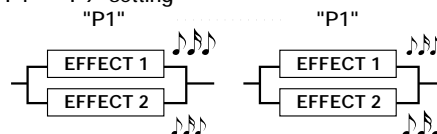

●Parameter 7 EFFECT2 RTM

Determines the change direction and control range for the parameter marked with "←RTM".

DELAY

This effect module contains mainly delay effects. When wishing to use the FUNCTION switch or optional remote pedal RP01 for the hold delay function, set the effect type for this effect module to "HOLD".

Parameter 1 TYPE	1. NORMAL	2. ANALOG	3. HOLD
Parameter 2	Time (x100mS) 0 ~ 20		
Parameter 3	Time (x1mS) 0 ~ 99		
Parameter 4	Feedback 0 ~ 10		
Parameter 5	Mix (RTM) 0 ~ 99, 1.0		
Parameter 6	SEAMLESS oF, 1 ~ 10,		
Parameter 7	DELAY RTM - 10 ~ +10		

■ Parameter 1 TYPE (Effect Type)

The following three effect types can be selected for the DELAY effect.

Type 1 NORMAL (Normal Delay)

Type 2 ANALOG (Analog Delay)

Type 3 HOLD (Hold Delay)

Depending on the selected effect type, the content of parameter 4 changes.

■ Type 1 NORMAL (Normal Delay)

Conventional delay effect with a maximum delay time of 2 seconds.

- **Parameter 2 Time (x100 ms)**
Determines the delay time in 100-ms units.
- **Parameter 3 Time (x1 ms)**
Determines the delay time in 1-ms units.
- **Parameter 4 Feedback**
Determines the delay feedback amount.
- **Parameter 5 Mix (←RTM)**
Determines the mixing balance between effect sound and original sound. "0" means original sound only, and "1.0" (100) means equal level of effect sound and original sound.

■ Type 2 ANALOG (Analog Delay)

Analog type delay with a soft sound character. The parameter content is the same as for type 1 (NORMAL).

■ Type 3 HOLD (Hold Delay)

This effect type samples a phrase of up two seconds and repeats it automatically.

- **Parameter 2 Time (x100 ms)**
Determines the hold delay time (maximum sampling time) in 100-ms units.
- **Parameter 3 Time (x1 ms)**
Determines the hold delay time in 1-ms units.
- **Parameter 5 Mix (←RTM)**
Determines the mixing balance between effect sound and original sound.

■ Common parameters for type 1 - 3

● Parameter 6 SEAMLESS

This parameter controls the seamless function. For details, please refer to the explanation of the seamless function below.

● Parameter 7 DELAY RTM Mode

Determines the change direction and control range for the parameter marked with "←RTM".

■ Seamless function

The seamless function lets the delay sound from the previous patch linger on when you switch patches, creating a smooth transition without audible breaks. The following settings can be made for seamless function:

- **oF**: Seamless function is off.
- **1 - 10**: Delay sound continues for the number of seconds set with this value, regardless of the Feedback parameter setting of the DELAY effect.
- **infinite**: Delay sound continues for the duration of the Feedback parameter setting of the DELAY effect.



- *If the delay time for the patch before switching or after switching exceeds 1 second (1001 ms or more), the seamless function becomes inactive.*
- *Also if the DELAY module is set to off for the patch after switching, a delay time setting of 1001 ms or more will cause the seamless function to become inactive when the DELAY module is set to off. Set the delay time to 1000 ms or less and turn the DELAY module off.*
- *When hold delay is used for a patch for which the seamless function value has been set to 1 - 10, the sampled phrase is repeated for the specified duration only. If the seamless function is set to <infinite> and patch hold delay is used, the repetition of the sampled phrase continues also when the patch is switched (until bypass/mute is activated).*

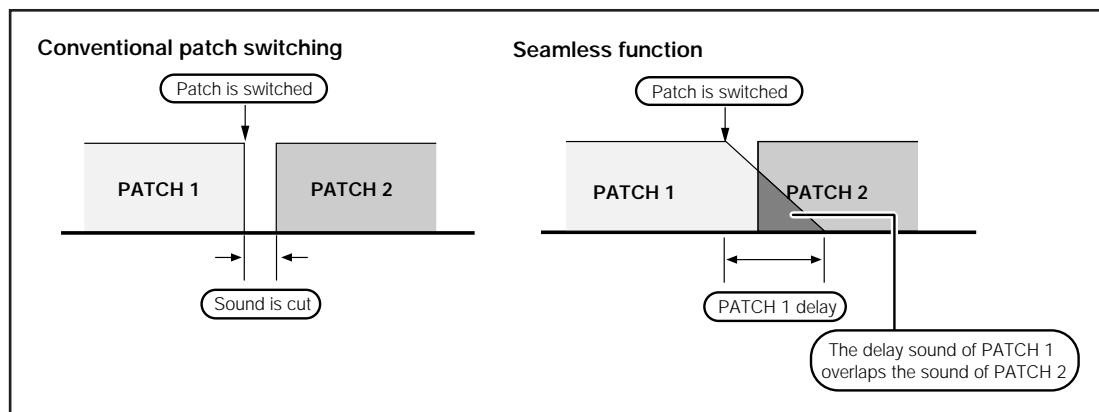

REVERB

This effect module contains reverberation effects. It also comprises the Patch Level parameter for adjusting the overall patch level, and the FUNCTION Mode parameter for selecting the FUNCTION switch operation.

Parameter 1 TYPE	1. HALL 1	2. HALL 2	3. ROOM 1	4. ROOM 2	5. PP-DELAY
Parameter 2	Time 1 ~ 30			Time (x10mS) 1 ~ 99, 1.0	
Parameter 3	Tone 0 ~ 10			FB 0 ~ 10	
Parameter 4	Mix (RTM) 0 ~ 99, 1.0				
Parameter 5	Patch Level(P) 1 ~ 50				
Parameter 6	FUNCTION Mode (G) 1 ~ 7				
Parameter 7	REVERB RTM - 10 ~ + 10				

Parameter 1 TYPE (Effect Type)

The following five effect types can be selected for the REVERB effect module:

- Type 1 HALL1 (Hall Reverb 1)
- Type 2 HALL2 (Hall Reverb 2)
- Type 3 ROOM1 (Room Reverb 1)
- Type 4 ROOM2 (Room Reverb 2)
- Type 5 PP-DELAY (Ping-Pong Delay)

Depending on the selected effect type, the content of parameters 2 - 3 changes.

Type 1 HALL1 (Hall Reverb 1)

Bright reverb effect simulating the sound of a concert hall.

- **Parameter 2 Time**
Determines the duration of the reverb.
- **Parameter 3 Tone**
Adjusts the high-frequency range of the effect. Lower values result in a softer sound with less treble.

Type 2 HALL2 (Hall Reverb 2)

Warm reverb effect simulating the sound of a concert hall. The parameter content is the same as for type 1 (HALL1).

Type 3 ROOM1 (Room Reverb 1)

Bright reverb effect simulating the sound of a room. The parameter content is the same as for type 1 (HALL1).

Type 4 ROOM2 (Room Reverb 2)

Warm reverb effect simulating the sound of a room. The parameter content is the same as for type 1 (HALL1).

Type 5 PP-DELAY (Ping-Pong Delay)

Ping-pong effect which bounces the effect sound between left and right.

- **Parameter 2 Time (x10 ms)**
Determines the delay time in 10-ms units.
- **Parameter 3 FB**
Determines the delay feedback amount.

Common parameters for type 1 - 5

- **Parameter 4 Mix (←RTM)**
Determines the mixing balance between effect sound and original sound.
- **Parameter 5 Patch Level (P)**
This patch parameter sets the overall level of the patch.
- **Parameter 6 FUNCTION Mode (G)**
This global parameter determines the operation of the FUNCTION switch. For information about the various modes, please refer to page 18.
- **Parameter 7 REVERB RTM**
Determines the change direction and control range for the parameter marked with "←RTM".

Troubleshooting

If there seems to be a problem with the unit, please check the following points first.

Problem	Check	Remedy
No Sound, or Extremely Small Sound	• Is the AC adapter connected correctly and the power ON?	⇒ Turn the power ON by following the instructions, "GETTING CONNECTED".
	• Is the INPUT jack correctly connected to the guitar, and the OUTPUT jack to the amplifier?	⇒ Connect them correctly by following the instructions, "GETTING CONNECTED".
	• Is your shielded cable ok?	⇒ Try changing your shielded cable.
	• Is the connected amplifier's power ON?	⇒ Turn the amplifier's power ON.
	• Is the volume appropriate for the guitar and amplifier?	⇒ Adjust the volume to the appropriate level.
	• LEVEL parameter of PRE DRIVE, MAIN DRIVE, or EQ effect module set too low?	⇒ Activate Edit mode (page 13 and adjust the parameter.
	• Is the cut with the EQ effect module parameter setting too strong?	⇒ Enter the Edit mode (see page13) and appropriately adjust the levels for each parameter.
	• Is the 3000 muted?	⇒ If the FUNCTION switch mode (see page 18) is set to "MUTE", press the FUNCTION switch to turn off the mute condition.
	• Master volume turned down?	⇒ Turn VALUE knob in Play mode to adjust the volume.
• Volume turned down with RP01 (option) foot pedal?	⇒ Operate RP01 foot pedal.	
Patches Do Not Switch	• Is the 3000 in Edit (Manual) mode?	⇒ Press FUNCTION switch to return to Play mode.
	• Is the 3000 in Store standby status or All Initialize standby status?	⇒ Press the STORE key to execute the operation, or press the EDIT key to leave the standby status and return to Play mode.
FUNCTION switch cannot be used for delay time tap input or hold delay.	• FUNCTION switch mode set correctly?	⇒ Set FUNCTION switch mode to "3: DELAY (TAP&HOLD)" (page 18).
	• Is RP01 (option) connected?	⇒ When RP01 is connected, delay time tap input and hold delay operation can be carried out only with RP01.
MAIN DRIVE effect module cannot be activated.	• Is TALKING BOX effect type selected for PRE DRIVE effect module?	⇒ In Edit mode, select a different effect type for PRE DRIVE. If TALKING BOX is selected, the MAIN DRIVE effect module cannot be activated even if the PRE DRIVE module is off.

Problem	Check	Remedy
<p>RP01 foot pedal cannot be used for RTM (including pedal wah and pedal pitch shifter).</p>	<ul style="list-style-type: none"> • Is a patch with RTM selected? • Is effect type with pedal wah or pedal pitch shifter selected? • Is Effect Monitor LED off (flashing)? • Is RP01 set to DELAY mode? • Is FUNCTION switch of 3000 set to "6: RTM"? 	<ul style="list-style-type: none"> ⇒ Activate Edit mode and make the RTM settings (page 23). ⇒ Verify that the PEDAL-WAH or PEDAL-PITCH effect type is selected for EQ or EFFECT1 (page 37, 38). ⇒ Press pedal switch so that LED becomes on (lit). ⇒ Press Mode Selector of RP01 to switch to RTM mode. ⇒ When FUNCTION switch is set to "6: RTM", RP01 foot pedal works as volume pedal. Set FUNCTION switch to other mode (page 32).
<p>Pedal wah or pedal pitch shifter does not turn on or off when integrated switch of RP01 pedal is pressed.</p>	<ul style="list-style-type: none"> • Is RP01 set to DELAY mode? • Is 3000 FUNCTION switch mode set to "6: RTM"? 	<ul style="list-style-type: none"> ⇒ Press Mode Selector of RP01 to switch to RTM mode. ⇒ When mode 6 (RTM) is activated, integrated switch of RP01 pedal cannot be used to switch pedal wah or pedal pitch shifter on and off (page 32). Select another mode.
<p>Talking box effect cannot be used with microphone.</p>	<ul style="list-style-type: none"> • Is microphone properly connected to MIC IN jack? • Is TALKING BOX selected as effect type for PRE DRIVE module? • Is MIC Level parameter of PRE DRIVE effect module set to a suitable value? 	<ul style="list-style-type: none"> ⇒ Connect microphone as described on page 30. ⇒ In Edit mode, verify that TALKING BOX is selected as effect type for PRE DRIVE module. ⇒ In Edit mode, try increasing the MIC Level parameter.

SPECIFICATIONS

Effect programs	37(35 effect types + Amp Simulator + ZNR)
Effect modules	7 + AMP + ZNR
Patch memory capacity	USER 10 banks x 4 = 40 (read and write) PRESET 10 banks x 4 = 40 (read only) Total 80 patches
Sampling frequency	39.0625 kHz
A/D converter	20 bit, 64 times oversampling
D/A converter	20 bit, 128 times oversampling
DSP	ZFx-2 (developed by ZOOM) x 2
Input	Guitar input (standard monaural phone jack) Rated input level: -20 dBm Input impedance: 470 kilohms Microphone input (standard monaural phone jack) Rated input level: -50 dBm Input impedance: 470 kilohms
Output	Combined line/headphone output (standard monaural phone jack) Max. output level: +6 dBm Output load impedance: 10 kilohms or more
Control connector	For optional RP01
Display	2-digit , 7-segment LED
Power requirements	9 VDC, 300 mA (from supplied AC adapter)
Dimensions	373 (W) x 200 (D) x 46 (H) mm
Weight	1.5 kg

* 0 dBm = 0.775 Vrms

* Design and specifications subject to change without notice.

USAGE AND SAFETY PRECAUTIONS

USAGE AND SAFETY PRECAUTIONS

In this manual, symbols are used to highlight warnings and cautions for you to read so that accidents can be prevented. The meanings of these symbols are as follows:



Warning

This symbol indicates explanations about extremely dangerous matters. If users ignore this symbol and handle the device the wrong way, serious injury or death could result.



Caution

This symbol indicates explanations about dangerous matters. If users ignore this symbol and handle the device the wrong way, bodily injury and damage to the equipment could result.

Please observe the following safety tips and precautions to ensure hazard-free use of the 3000.



Warning

• Power requirements

The 3000 is powered by the supplied AC adapter. To prevent malfunction and safety hazards, do not use any other kind of AC adapter.

When using the 3000 in an area with a different line voltage, please consult your local ZOOM distributor about acquiring a proper AC adapter.



Caution

• Environment

Avoid using your 3000 in environments where it will be exposed to:

- Extreme temperature
- High humidity or moisture
- Excessive dust or sand
- Excessive vibration or shock



Caution

• Handling

Since the 3000 is a precision electronic device, avoid applying excessive force to the switches and buttons. Also take care not to drop the unit, and do not subject it to shock or excessive pressure.



Caution

• Alterations

Never open the case of the 3000 or attempt to modify the product in any way since this can result in damage to the unit.



Caution

• Connecting cables and input and output jacks

You should always turn off the power to the 3000 and all other equipment before connecting or disconnecting any cables. Also make sure to disconnect all cables and the AC adapter before moving the 3000.

Usage Precautions

• Electrical interference

For safety considerations, the 3000 has been designed to provide maximum protection against the emission of electromagnetic radiation from inside the device, and protection from external interference. However, equipment that is very susceptible to interference or that emits powerful electromagnetic waves should not be placed near the 3000, as the possibility of interference cannot be ruled out entirely.

With any type of digital control device, the 3000 included, electromagnetic interference can cause malfunctioning and can corrupt or destroy data. Care should be taken to minimize the risk of damage.

• Cleaning

Use a soft, dry cloth to clean the 3000. If necessary, slightly moisten the cloth. Do not use abrasive cleanser, wax, or solvents (such as paint thinner or cleaning alcohol), since these may dull the finish or damage the surface.

Please keep this manual in a convenient place for future reference.



ZOOM CORPORATION

NOAH Bldg., 2-10-2, Miyanishi-cho, Fuchu-shi, Tokyo 183-0022, Japan

PHONE: 0423-69-7116 FAX: 0423-69-7115

Printed in Japan 3000-5000