

V6

Vocal Processor

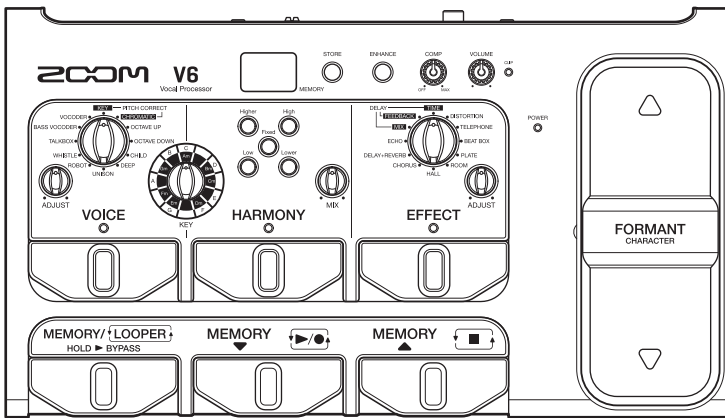

Quick Guide

You must read the Usage and Safety Precautions before use.



The Operation Manual can be downloaded from the ZOOM website (www.zoom.jp/docs/v6).
 This page has files in PDF and ePub formats.
 The PDF file format is suitable for printing on paper and reading on a computer.
 The ePub format can be read with electronic document readers and is designed for reading on smartphones and tablets.

© 2019 ZOOM CORPORATION

Copying or reprinting this manual in part or in whole without permission is prohibited.

Product names, registered trademarks and company names in this document are the property of their respective companies.

You might need this manual in the future. Always keep it in a place where you can access it easily.

The contents of this manual and the specifications of the product could be changed without notice.

Functions of parts

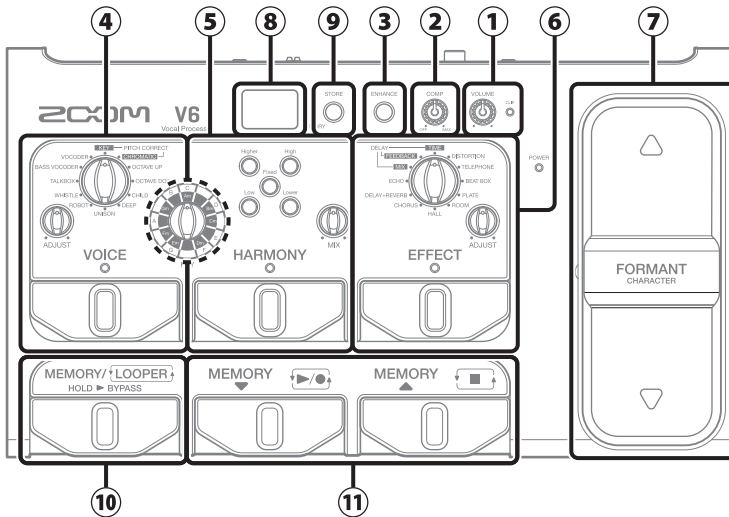

- ① **VOLUME knob**
This adjusts the volume input from the mic.
- ② **COMP knob**
This compressor reduces volume variation.
- ③ **ENHANCE button**
This increases vocal clarity.
- ④ **VOICE section**
This can alter vocals with pitch correction, pitch shifting, vocoder and other options.
- ⑤ **HARMONY section**
This can add up to two harmonizing voices.
- ⑥ **EFFECT section**
Use this to apply delay, reverb or another effect.
- ⑦ **FORMANT pedal**
This changes the character of the voice without changing the pitch.
- ⑧ **Display**
This shows the patch memory number and looper status
- ⑨ **STORE button**
This saves the VOICE, HARMONY, and EFFECT settings as a patch memory.
- ⑩ **MEMORY/LOOPER footswitch**
Use to switch between memory selection and looper functions and to bypass the effect for the input.
- ⑪ **MEMORY ▼/▲ footswitches**
Use to select patch memories and operate the looper.

Making connections

Mic (ZOOM SGV-6 or commercially-available mic)

Use a mic cable to connect it to the MIC IN jack.



or



PHANTOM



When connecting a ZOOM SGV-6, condenser mic or other device that requires phantom power, set the PHANTOM switch to ON.

Stereo mini plug headphones



Mixer, PA system, recorder, etc.

Connect a cable with an XLR connector (female) to the OUTPUT jack.

Use a cable with a connector that suits the PA system or recorder input jack.

The **V6** output is line level. Connect it to a line input jack on the other equipment.

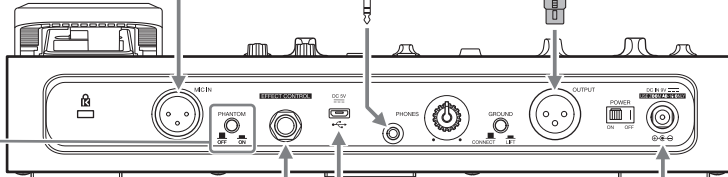
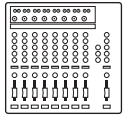

Expression pedal (ZOOM FP02M)

Connect it to the EFFECT CONTROL jack. The pedal can be used to control the effect.

AC adapter (ZOOM AD-16)



NOTE

Always set the PHANTOM switch to OFF when connecting a device that does not support phantom power. If this is not done, the device could be damaged.

HINT

- 4 AA batteries can also be used. Use only one type of battery (alkaline, NiMH or lithium) at a time.
- Power for operation can also be supplied through the USB port.

Turning the power on

1. Minimize the volume of output devices.

2. Set to ON.

This turns the **V6** on, and  lights green.

3. Raise the volume of output devices.

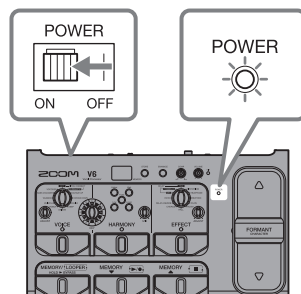

NOTE

- By default, the ECO mode setting is ON, so the power will automatically turn off if no use occurs for 10 hours. ECO mode can also be set to "OFF"
-  lights red when the remaining battery power becomes low. Replace the batteries with new ones.

ZOOM SGV-6 mic overview

The SGV-6 is a mic with focused directionality based on the technologies of shotgun mics, which are designed to capture sound in the direction they are pointed. By capturing only the vocal, sounds from other instruments on stage are suppressed, enabling accurate pitch correction and harmonization.

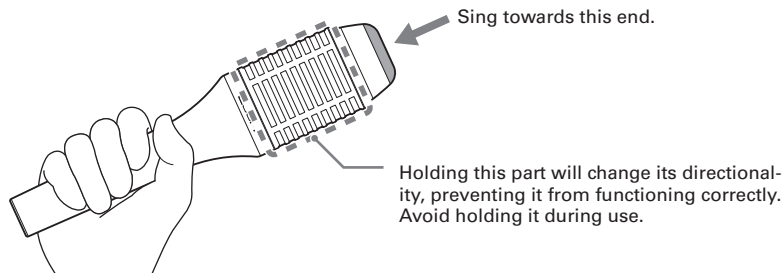

Note: The SGV-6 is a delicate device. Do not drop it or hit it with excessive force.

Bypassing the V6 effect

1. Press and hold  .

This bypasses the **V6** effect.

In memory mode



The patch memory number and "bP" alternate on the display.

In looper mode



The looper status and "bP" alternate on the display.

Press  again to stop bypassing.

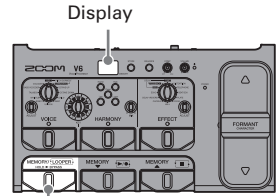

HOLD ► BYPASS

Adjusting the volume and tone

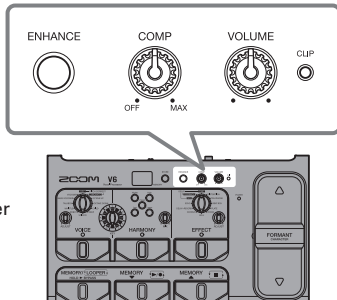

The volume and tone of the input from the mic can be adjusted.

■ Adjusting the mic input volume



NOTE

Adjust the mic input volume to a level that enables the VOICE and HARMONY sections to function properly.

-  Lit red: Volume too high
-  Lit green: Volume just right
- Unlit: Volume too low

■ Reducing volume variation (compressor function)



Input volumes over a certain level can be compressed to even out the volume. Turn it right to increase the effect. Turn it completely left to turn the compressor function off.

■ Bring out vocal character (enhance function)



This turns the enhance function on and  lights.

This suppresses sibilant sounds, bringing out other vocal characteristics.

■ Adjusting headphone volume

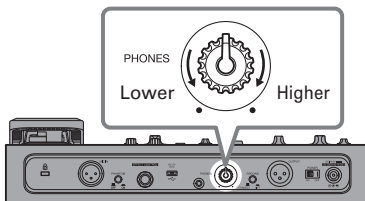

Selecting patch memories

The **V6** comes with patch memories that allow a variety of vocal sounds to be tried right away. Try selecting one you like and singing with it.

(Patch memories contain all VOICE, HARMONY AND EFFECT section settings.)

When the **V6** is turned on, the patch memory number is shown on the display.

1. Press  or .

Select the patch memory.

The selected patch memory number is shown on the display.

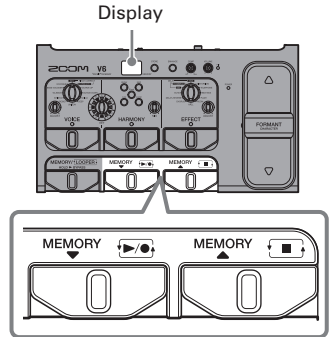

HINT

If VOICE, HARMONY or EFFECT settings are adjusted,  will light, showing that they are different from the saved settings. Save the settings as needed.

Using the VOICE section

This can alter vocals, including with pitch correction, pitch shifting, vocoder and other options.

1. Press .

The VOICE section is activated, and VOICE lights.

2. Turn  VOICE.

Select the voice.

3. Turn  ADJUST.

Adjust the voice.

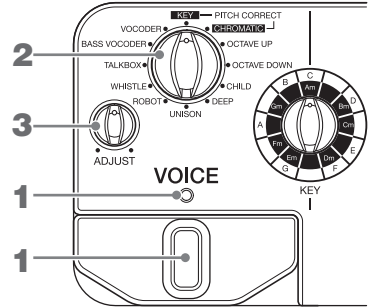

Voice	Explanation	ADJUST function
PITCH CORRECT - KEY	Corrects pitch to the set key	Pitch correction amount
PITCH CORRECT - CHROMATIC	Corrects pitch to semitones	Pitch correction amount
OCTAVE UP	Doubles the voice one octave up	Balances original and effect sounds
OCTAVE DOWN	Doubles the voice one octave down	Balances original and effect sounds
CHILD	Makes voice high-pitched and childlike	Pitch correction amount
DEEP	Makes voice deep, heavy and low	Pitch correction amount
UNISON	Sounds like a clone is singing with the singer	Effect mix level
ROBOT	Robot voice with fixed pitch	Robot voice octave
WHISTLE	Transforms singing into whistling	Amount of original sound in mix/whistle octave
TALKBOX	Talk box sound	Pitch correction amount
BASS VOCODER	Bass vocoder one octave down	Pitch correction amount
VOCODER	Vocoder sound	Pitch correction amount

Using the HARMONY section

In the HARMONY section, two of the five options can be selected to generate harmonies automatically based on the KEY setting.

1. Press .

The HARMONY section is activated, and **HARMONY** lights.

2. Turn .

This sets the key.
When using sheet music, the key can be determined from the key signature.

Major key

C	F	B ^b	E ^b	A ^b	D ^b
---	---	----------------	----------------	----------------	----------------



Minor key

A ^m	D ^m	G ^m	C ^m	F ^m	B ^b m
----------------	----------------	----------------	----------------	----------------	------------------





Major key

C	G	D	A	E	B	F [#]
---	---	---	---	---	---	----------------



Minor key

A ^m	E ^m	B ^m	F [#] m	C [#] m	G [#] m	D [#] m
----------------	----------------	----------------	------------------	------------------	------------------	------------------

3. Press , , ,  or .

Press  repeatedly to cycle through volume levels: high → medium → low → off.
The brightness changes with the level.

Up to two harmony options can be activated. Activating a third harmony option will cancel the one that was first activated.

Harmony option	Explanation
Higher	Pitch is +5 or +6 degrees
High	Pitch is +3 or +4 degrees
Fixed	The note of the key set in step 2 (fixed)
Low	Pitch is -3 or -4 degrees
Lower	Pitch is -5 or -6 degrees

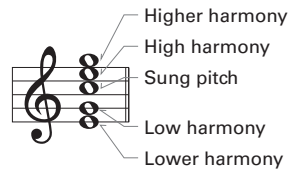

4. Turn .

This adjusts the balance between your voice and the harmony.
Only the harmony sound will be output when turned all the way to the right.

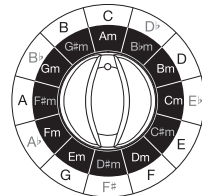
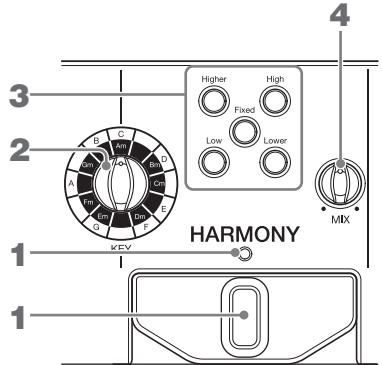

Key selection knob

Using the EFFECT section

Use this to add delay, reverb or another effect.

1. Press .

The EFFECT section is activated, and  lights.

2. Turn .

Select the effect.

3. Turn .

Adjust the effect.

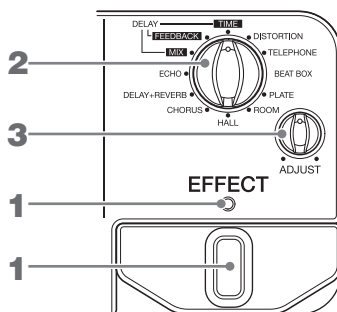

Effect	Explanation	ADJUST function
DISTORTION	Distorts the voice heavily	Distortion amount
TELEPHONE	Retro-sounding telephone emulation	Frequency band affected
BEAT BOX	Adds impact for beat boxing	Boost amount
PLATE	Plate reverb simulation	Reverb duration and mix amount
ROOM	Tight reverb that simulates room acoustics	Reverb duration and mix amount
HALL	Dense reverb that simulates hall acoustics	Reverb duration and mix amount
CHORUS	Thick, gentle chorus	Effect mix level
DELAY+REVERB	Combines delay and reverb	Reverb duration and mix amount
ECHO	Crisp short delay that brings out clarity	Effect mix level
DELAY*	TIME	Delay time
	FEEDBACK	Feedback amount
	MIX	Effect mix level

* The DELAY effect is adjusted by the DELAY - TIME, DELAY - FEEDBACK and DELAY - MIX settings.

HINT

- When DELAY - TIME is selected,  functions as a tap tempo setting switch for the delay time.
- An expression pedal (ZOOM FP02M) can also be used to adjust the effect.

Saving settings in patch memories

VOICE, HARMONY, and EFFECT settings can be saved as patch memories.

1. Press .

The display blinks.

2. Press  or .

Select the destination patch memory.

The selected patch memory number is shown on the display.

3. Press .

The current settings are saved.

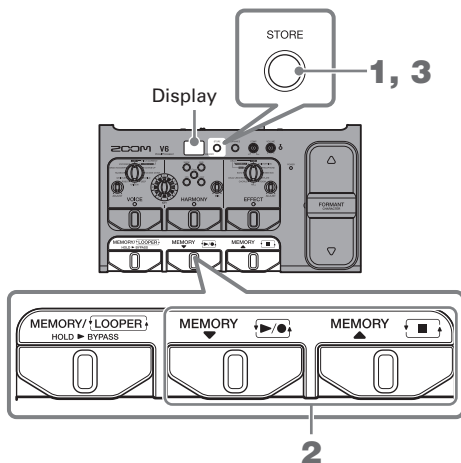

HINT

Press  to cancel saving.

Using the FORMANT pedal

The FORMANT pedal can be used to change the vocal character without changing the pitch.

1. Operate the FORMANT pedal.

This changes the character of the voice.

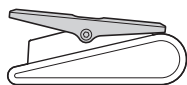

Press forward (toe)
This makes the voice higher and cuter.

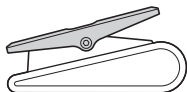

Press backward (heel)
This makes the voice lower and heavier.

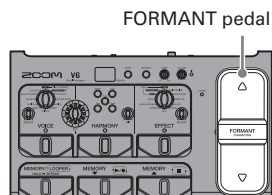

HINT

The FORMANT pedal torque can be adjusted so that it responds as you like to pressing. See the Operation Manual for details.

Using the looper

Vocals can be recorded and loops created for up to 3.5 minutes.

Loops can be layered for a variety of live performance techniques, including a capella choruses and vocal percussion.

■ Activating the looper

Press  .

 appears on the display.

■ Starting loop recording

Press  .

 appears on the display.

HINT

Cancel: Press  .

 appears on the display.

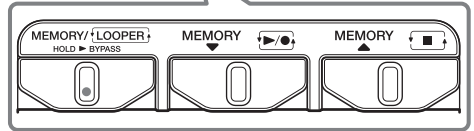
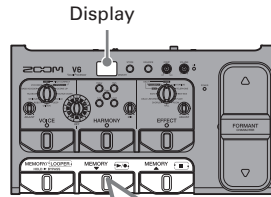

■ Stopping recording and starting loop playback

Press  .

 appears on the display.



■ Overdubbing additional loops during playback

Press  .

 appears on the display.



■ Removing the last recorded loop

During loop playback, press  twice quickly.

After  blinks on the display,  appears.

■ Restoring the removed loop

After removing a loop, press  twice quickly again.

After  blinks on the display,  appears.

■ Stopping loop playback

Press .





 Blinks on the display.

■ Deleting recorded loops

When loop playback is stopped, press and hold .

 appears on the display.

Display indicators

Indicator	Explanation
	LOOPER: No loop recorded
	REC: Loop being recorded
	PLAY: Loop being played back (blinks when stopped)
	UNDO: Last overdubbed loop being removed
	REDO: Loop removed using UNDO being restored

Setting other functions

1. While pressing and holding  ,

 or  , set  to ON.

After the function name appears on the display, the setting value appears.









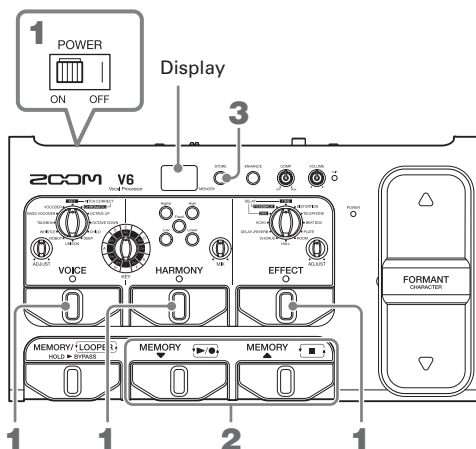



2. Press  or  .

Select the setting.

3. Press  .

This saves the setting, and the **V6** starts normal operation.



Setting name	Startup switch	Setting options	Explanation
Pitch calibration 		 435 Hz  445 Hz	This adjusts the standard pitch used for correcting vocal pitch and adding harmony.
Battery setting 		 Alkaline batteries  Nickel-metal hydride batteries  Lithium batteries	Select the type of battery used.
ECO mode setting 		 On  Off	This turns ECO mode on/off.

HINT

See the Operation Manual for detailed information about all the functions.

Specifications

VOICE section		12 types
EFFECT section		10 types
HARMONY section		5 types
Sampling frequency		44.1 kHz
A/D conversion		24-bit 128x oversampling
D/A conversion		24-bit 128x oversampling
Signal processing		32-bit
Frequency response		20 Hz – 20 kHz (+1 dB/–3 dB) (200 k Ω load)
Display		2-digit 7-segment LED
Inputs	SGV-6	Directionality: Super cardioid (3 directional mic units) Sensitivity: –46 dB/1 Pa at 1 kHz (each mic unit) Maximum input sound pressure: 140 dB SPL
	MIC IN	XLR jack Input gain: +3 – +40 dB Maximum input level: +4 dBu Input impedance: 3 k Ω or more (1 kHz) Phantom power: +48 V
Outputs	OUTPUT	XLR jack Maximum output level: +8 dBu Output impedance: 50 Ω (HOT-GND, COLD-GND, 1 kHz) 100 Ω (HOT-COLD, 1 kHz) GROUND LIFT (switchable)
	PHONES	Stereo mini jack Maximum output level: 20 mW + 20 mW (into 32 Ω load)
Equivalent input noise (when phantom power off)		–125 dBu or less (A-weighted, 150 Ω input, +40 dBu input gain)
Noise floor (residual noise)		–75 dBu
Control input		FP02 input
Power		AC adapter (9V DC 500mA, center negative) (ZOOM AD-16) 4 AA batteries (about 3.5 hours continuous operation time when using alkaline batteries)
USB		Connector: Micro USB Audio interface operation: 2-in/2-out USB2.0 Full Speed, 44.1 kHz, 16/24/32-bit <ul style="list-style-type: none"> • Power can also be supplied through the USB port. • When using a cable designed only for power, other USB functions cannot be used.
External dimensions		181 mm (D) \times 320 mm (W) \times 77 mm (H)
Weight		1.56 kg (excluding batteries)
Optional		FP02 expression pedal

Note: 0 dBu = 0.775 V



ZOOM CORPORATION

4-4-3 Kanda-surugadai, Chiyoda-ku, Tokyo 101-0062 Japan
www.zoom.co.jp