

Q2n-4K

Handy Video Recorder

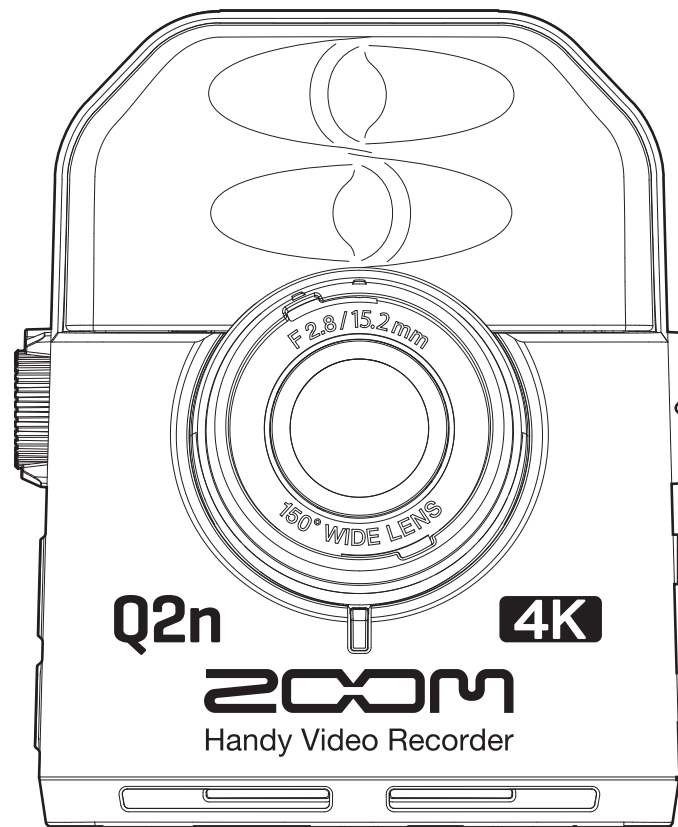

Operation Manual

You must read the Usage and Safety Precautions before use.

This document cannot be displayed properly on black-and-white displays.

© 2022 ZOOM CORPORATION

Copying or reprinting this manual in part or in whole without permission is prohibited.

Operation Manual overview

You might need this manual in the future. Always keep it in a place where you can access it easily. The contents of this document and the specifications of the product could be changed without notice.

- iOS is a trademark or registered trademark of Cisco Systems, Inc. (USA).
- The terms HDMI and HDMI High-Definition Multimedia Interface, and the HDMI Logo are trademarks or registered trademarks of HDMI Licensing Administrator, Inc. in the United States and other countries.
- Other product names, registered trademarks and company names in this document are the property of their respective companies.

Note: All trademarks and registered trademarks in this document are for identification purposes only and are not intended to infringe on the copyrights of their respective owners.

Recording from copyrighted sources, including CDs, records, tapes, live performances, video works and broadcasts, without permission of the copyright holder for any purpose other than personal use is prohibited by law. Zoom Corporation will not assume any responsibility related to infringements of copyrights.



Introduction

Thank you very much for purchasing a ZOOM **Q2n-4K** Handy Video Recorder (hereafter, “**Q2n-4K**”). The **Q2n-4K** has the following features.

Capture the immediacy of live performances in both audio and video

Using the wide angle lens, you can record video even when close to the subject. With the XY format condenser mic that has excellent sound pressure resistance, you can record even clearer stereo images at high resolutions up to 24-bit/96 kHz.

Record fine video details

By recording with 4K resolution, you can capture images that are four times as detailed as full HD. With ultra-high-resolution technology, clarity is not lost even when changing viewing angles.

Capture extreme lighting changes beautifully

Incorporating high dynamic range (HDR) technologies enables video recording of live performances with extreme lighting changes that avoids undersaturation and oversaturation.

Scene settings for a wide range of filming conditions

Along with settings good for recording live performances, monochrome and sepia special effect settings as well as a flat setting ideal for color matching have been added.

Easy live streaming

Connect to a computer and use the web camera function to easily set up a live streaming system with high audio and video quality.

Contents

Introduction	3
Contents	4
Names of parts	6
Preparations	10
Supplying power	10
Using batteries	10
Using an AC adapter	11
Inserting microSD cards	12
Turning the power on/off	13
Turning the power on	13
Setting up when first turned on	14
Setting the language shown	14
Setting the date and time	15
Recording	16
Recording Screen overview	16
Making video recording settings	17
Setting the video quality	17
Setting the field of view	18
Setting the scene type	19
Setting low-frequency noise reduction	20
Setting the audio quality	20
Adjusting recording levels	21
Adjusting levels manually	21
Using automatic level adjustment	22
Recording	23
Connecting external input devices	24
Playing recordings	25
Playback Screen overview	25
Playing recordings	26
Playback operations	27
Adjusting the output volume	28
Headphone/line output	29
Viewing on an HDMI-compatible TV	30
Managing files	31
Checking file information	31
Deleting files	32
Using USB functions	34
Connecting to computers and iOS devices	34
Turning the power on when connected to a computer	37

Using as a web camera	38
Compensating for lags between video and audio.....	38
Using as a card reader.....	39
Using as a USB mic	40
Enabling direct monitoring.....	40
Battery settings	41
Setting the type of battery used.....	41
Enabling energy saving	43
Setting the display backlight time.....	43
Setting the Auto Power Off function	45
Setting the date and time	47
Setting the volume of the operation sound	48
Enabling continuous playback	49
Using mics that support plug-in power	50
Setting the standard frame rate	51
Setting the language shown	52
Formatting microSD cards	53
Restoring factory default settings	54
Updating the firmware	56
Responding to warning messages	58
Troubleshooting	59
Recording/playback trouble.....	59
Specifications	60

Names of parts

■ Front

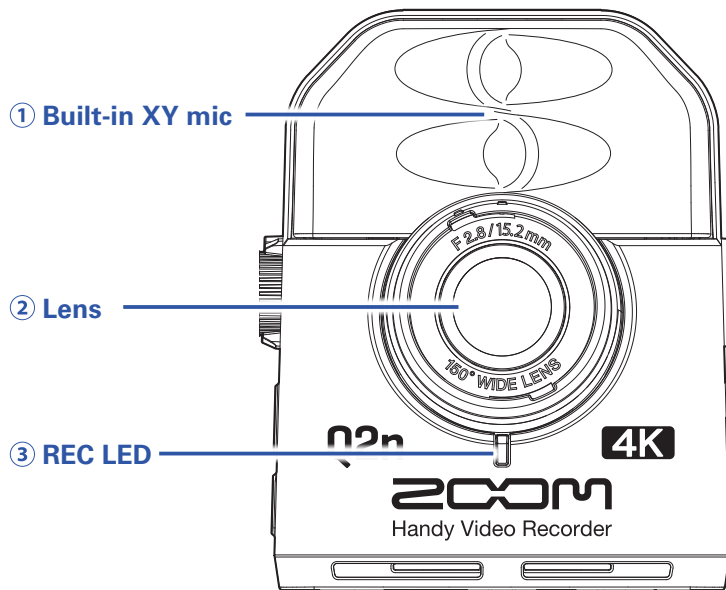

① Built-in XY mic

The two crossing directional mics can record a three-dimensional sound with natural depth and width.

② Lens

This lens has an F2.8 brightness and 150° wide angle.

③ REC LED

This LED shows the recording status. It lights red during recording.

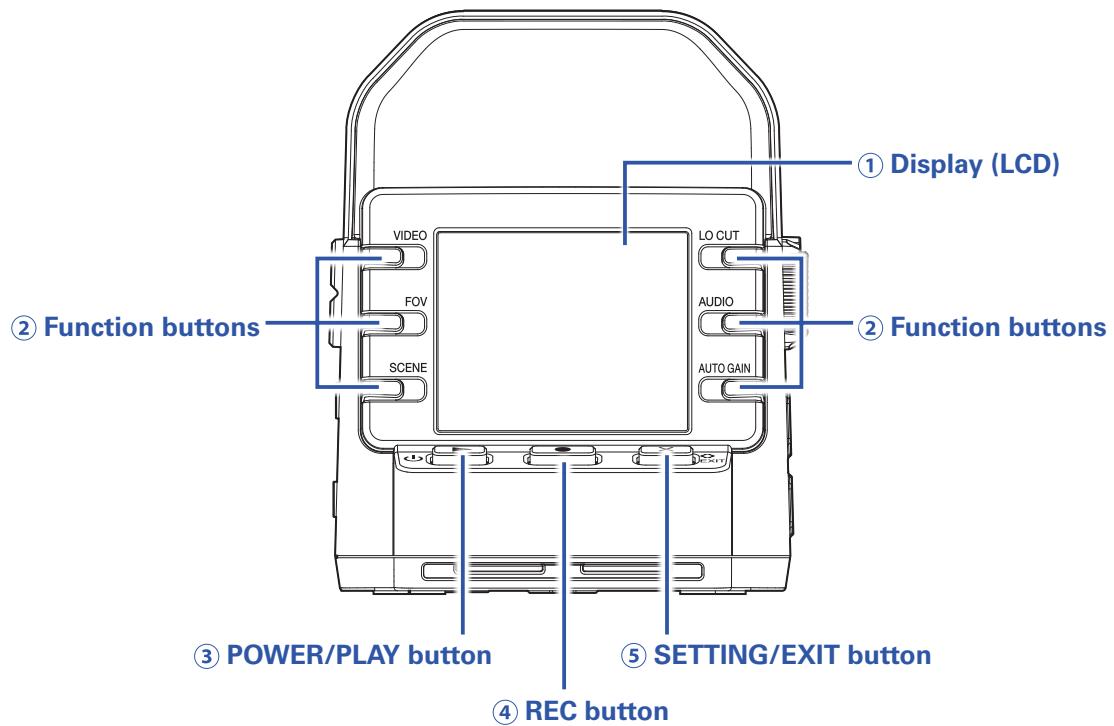

① Display (LCD)

This shows the video and various types of information.

② Function buttons

Use these to operate the functions shown on the display.

③ POWER/PLAY button

Use this to turn the power ON/OFF and to start video playback.

④ REC button

Use this to start and stop recording. Use this to confirm on setting and confirmation screens.

⑤ SETTING/EXIT button

Use this to open and close the Setting Screen. Use this to cancel on setting and confirmation screens.

■ Sides

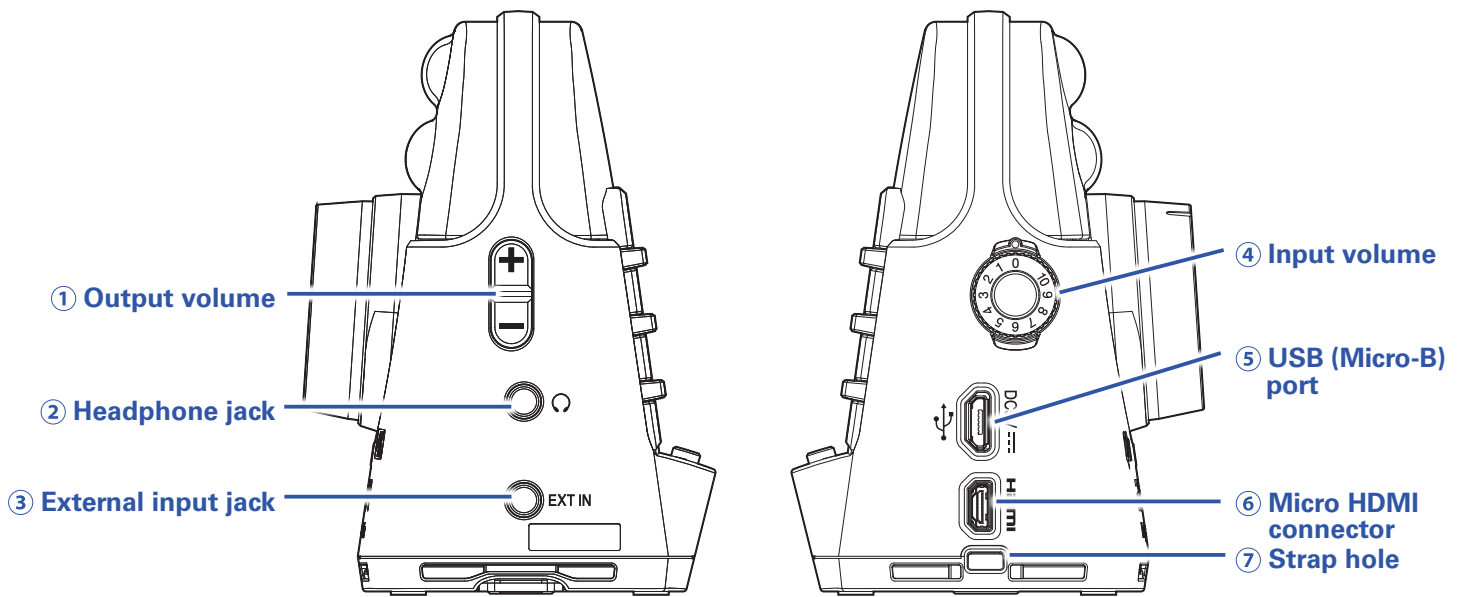

① Output volume control

Use to adjust the output volume.

② Headphone jack

This outputs sound to headphones or a connected device.

③ External input jack

Use this to input sound from a connected device.

④ Input volume dial

Use to adjust the recording level.

⑤ USB (Micro-B) port

Connect this to a computer or iOS device to use as a web camera, card reader or USB mic. The dedicated AC adapter (ZOOM AD-17) can also be connected here to use AC power.

⑥ Micro HDMI connector

This can output video and audio to an HDMI-compatible TV or other device.

⑦ Strap hole

A strap can be attached to help prevent dropping.

Attaching the included lens cap to a strap could help prevent loss.

■ Bottom

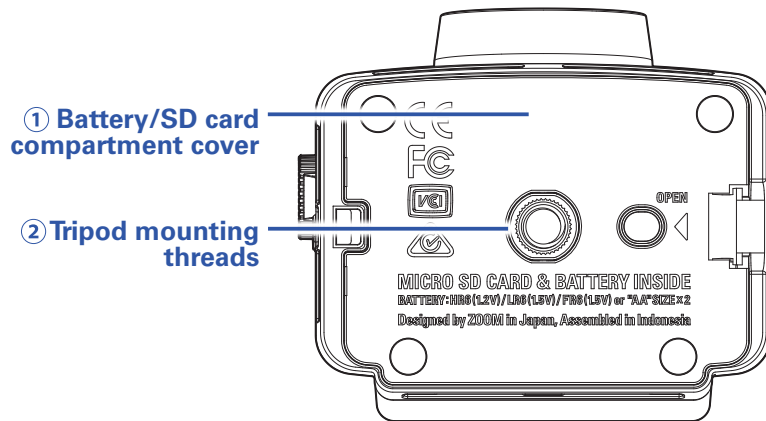

① Battery/SD card compartment cover

Remove when installing batteries and microSD cards.

② Tripod mounting threads

Use these screw threads to attach a tripod (not included).

Preparations

Supplying power

Using batteries

1. Open the battery/card compartment cover.

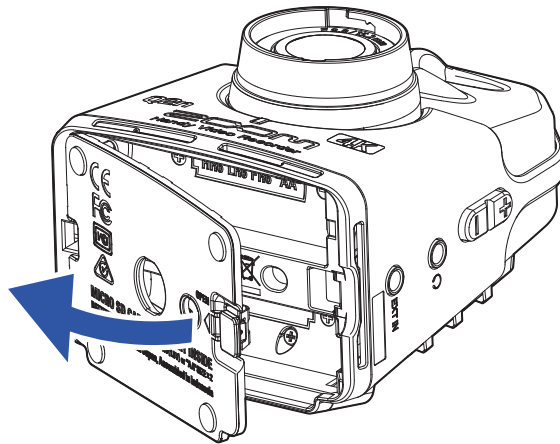

2. Install the batteries.

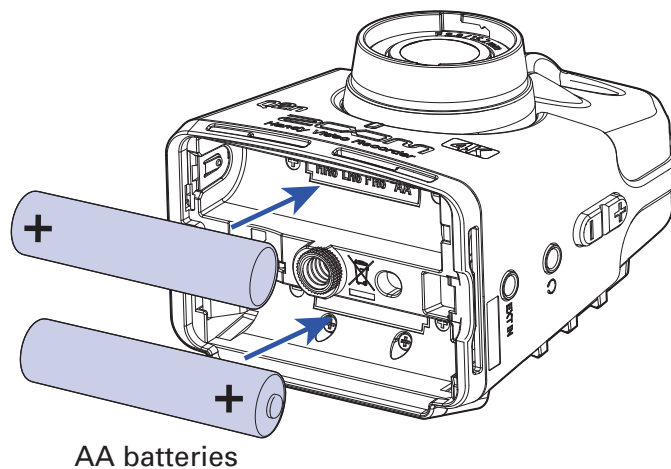

3. Close the battery/card compartment cover.

NOTE

- Use only one type of battery (alkaline, NiMH or lithium) at a time.
- After installing batteries, set the correct battery type. (→ [“Setting the type of battery used”](#) on page 41)

Using an AC adapter

1. Connect the cable of an AD-17 AC adapter to the USB port.

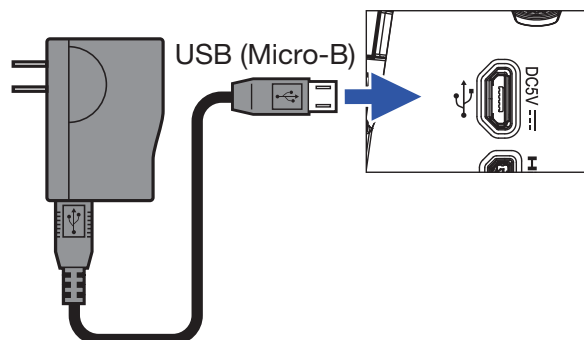

2. Plug the AC adapter into an outlet.

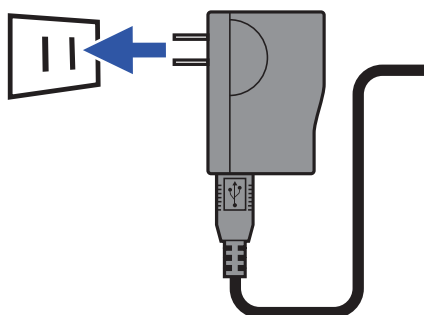

HINT

When connected to a computer, power can be supplied by USB.

Inserting microSD cards

1. Open the battery/card compartment cover.

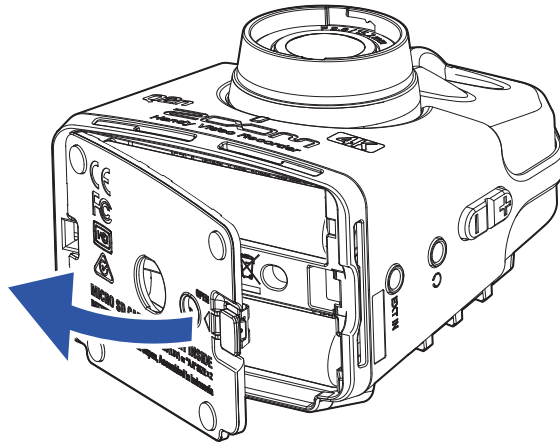

2. Insert the microSD card into the card slot.

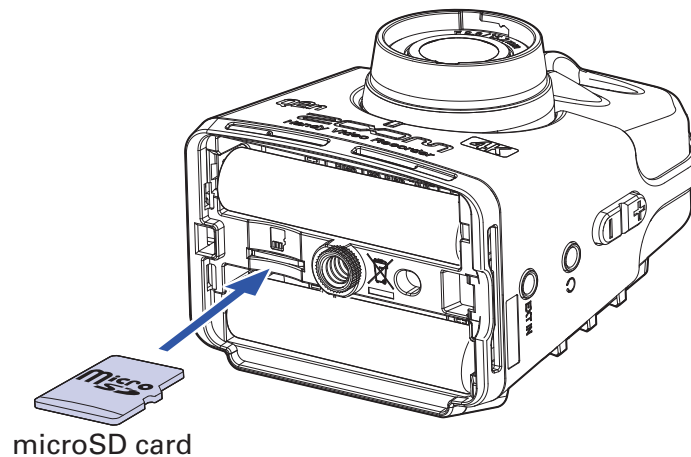

To remove a microSD card, push it further into the slot and then pull it out.

3. Close the battery/card compartment cover.

NOTE

- Always make certain that the power is off when inserting or removing a microSD card. Inserting or removing a card while the power is on could result in data loss.
- When inserting a microSD card, be sure to insert the correct end with the top side up as shown.
- After purchasing a new microSD card, always format it using the **Q2n-4K** to maximize performance. To format a microSD card, see [“Formatting microSD cards” on page 53](#).
- Use a microSD card that is Class 10 or higher. When recording at 4K resolution, use a microSD card that is UHS Speed Class 3 or higher.

Turning the power on/off

Turning the power on

1. Press and hold .

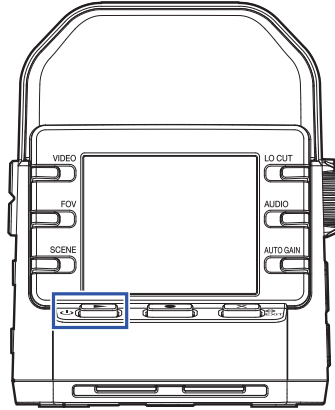

After startup completes, the REC LED on the front will light green and the Recording Screen will appear on the display.

HINT

To turn the power off, keep pressing  until "Goodbye See You!" appears on the display.

Setting up when first turned on

The first time the **Q2n-4K** is turned on, the display language and the date and time must be set.

HINT

Language display and date and time settings can be changed later on the Setting Screen. (→ [“Setting the language shown”](#) on page 52, [“Setting the date and time”](#) on page 47)

Setting the language shown

1. Use < and > to select the language displayed.

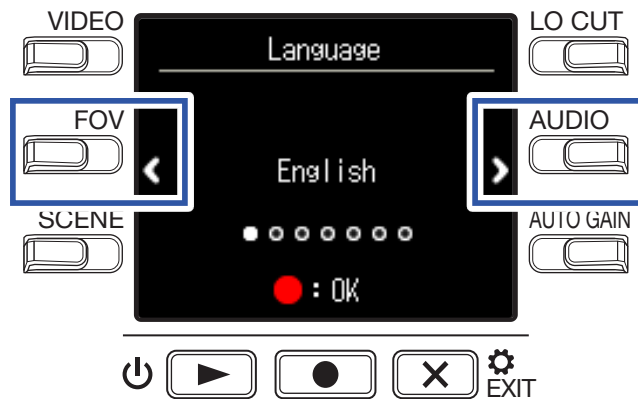

2. Press  to confirm.

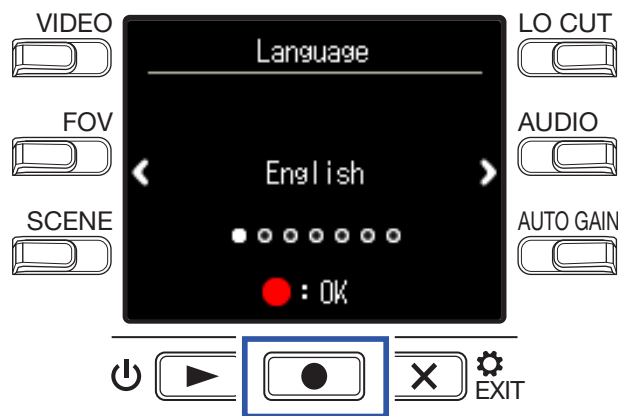

Setting the date and time

1. Press the button for the item to be set.

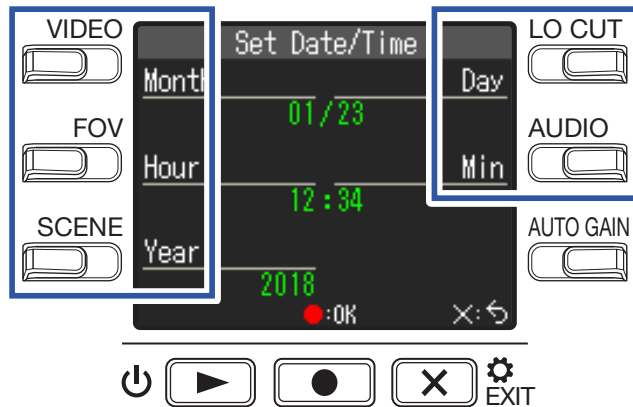

2. Press  to confirm.

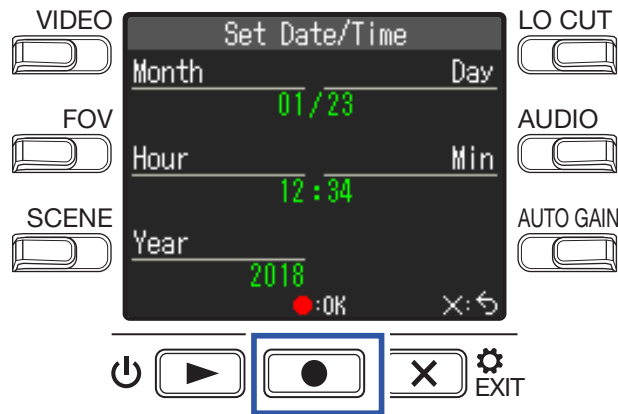

NOTE

- If power is not supplied by an AC adapter or batteries for a long time, date and time settings will be reset.
- If the date and time setting screen appears during startup, set them again.

Recording

Recording Screen overview

The Recording Screen opens when the power is turned on.

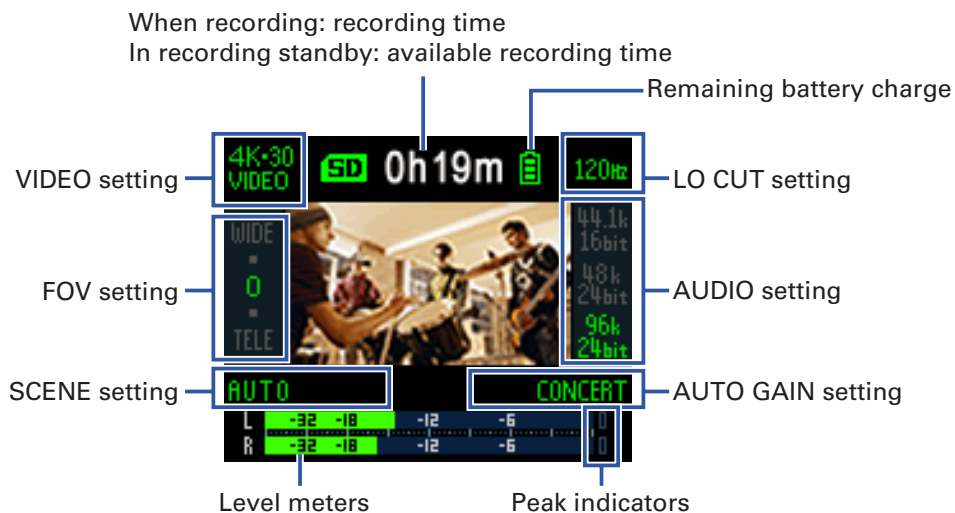

HINT

If the power is turned on when connected to a computer, the USB function selection screen will open. (→ [“Turning the power on when connected to a computer” on page 37](#))

Making video recording settings

Use the buttons on both sides of the display to change settings.



Setting the video quality

The video quality (resolution) and frame rate per second can be set.

1. Press  on the Recording Screen to set the video quality.



Setting	Resolution	Frames/second	Explanation	File size
4K-30 VIDEO	3840×2160	30	Record 4K video quality. Use when video quality is the top recording priority.	Large ↑
4K-24 CINEMA	3840×2160	24	Record 4K video quality. Record with the frame rate used for filming movies. This is good for recording movies and music videos.	
1080-60 SMOOTH	1920×1080	60	Use when you want to record subjects that move quickly.	
1080-30 VIDEO	1920×1080	30	This is suitable for all kinds of video recording.	
1080-24 CINEMA	1920×1080	24	Record with the frame rate used for filming movies. This is good for recording movies and music videos.	
720-30 VIDEO	1280×720	30	This is good when you want to balance recording time with video quality.	
CAMERA OFF	–	–	Use this to only record audio.	↓ Small

HINT

The standard frame rate can also be set for the regional video format. (→ [“Setting the standard frame rate”](#) on page 51)

Setting the field of view

This sets the field of view (FOV) for videos.

1. Press  on the Recording Screen to set the field of view.



Setting	Explanation	Distortion correction
WIDE	This widens the field of view.	—
.	↑	✓
0	↕	✓
.	↓	✓
TELE	This narrows the field of view.	✓

Setting the scene type

This sets the camera settings for the recording conditions (scene).

1. Press  on the Recording Screen to set the scene type.



Setting	Explanation
AUTO	Settings change according to the recording conditions.
OUTDOOR	Settings are optimized for outdoor recording.
SUNSET	Settings are optimized for sunset scenes.
NIGHT	Adjustments are made for night and other dark situations.
CONCERT LIGHT	Settings are suitable for concert lighting that is bright and changes drastically.
JAZZ CLUB	Settings are suitable for jazz clubs and similar venues.
DANCE CLUB	Settings are suitable for dance clubs and venues where lighting changes drastically.
MONOCHROME	Recording is processed to be like black and white film.
SEPIA	Recording is processed with a sepia tone.
FILM	Recording is processed to be like film.
X-PROCESS	A cross-processing effect is applied.
FLAT	This is suitable for color matching with other cameras in post-processing.

Setting low-frequency noise reduction

The low-cut filter can be set to reduce the sound of wind, vocal pops and other noise.

1. Press  on the Recording Screen to set the low-frequency noise reduction.



Setting	Explanation
OFF	Low-frequency noise reduction is disabled.
80 Hz	These set the cutoff frequency.
120 Hz	
160 Hz	

NOTE

The higher the cutoff frequency is set, the stronger the low-frequency noise reduction effect will be. Since this also affects other low-frequency sounds, though, check the effect while you are making this setting.

Setting the audio quality

This sets the sampling frequency (kHz) and bit rate.

1. Press  on the Recording Screen to set the audio quality.



Setting	Explanation	Audio quality	File size
44.1 kHz/16-bit	The higher the sampling frequency (kHz) and bit rate are set, the better the audio quality will be.	↑ Low	↑ Small
48 kHz/24-bit		↓ High	↓ Large
96 kHz/24-bit			

Adjusting recording levels

Adjusting levels manually

1. Turn  to adjust the recording level.

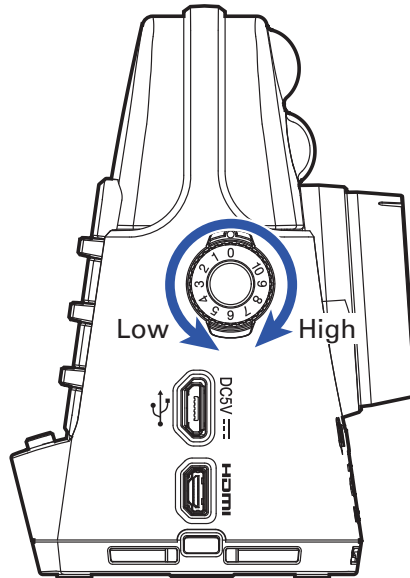

Adjust so that the level meters are around -12 dB with the loudest sounds.



NOTE

- The peak indicators light and the REC LED on the front blinks when loud sounds are input.
- Recording when the indicators are lit could cause the sound to become distorted. Lower the input volume to avoid this.
- If the sound distorts even when you lower the input volume, try changing mic positions and adjusting the output levels of connected devices.

HINT

To clear the peak indicators, press   to open the Setting Screen once.

Using automatic level adjustment

The recording level can be adjusted automatically according to the use conditions.

1. Press  on the Recording Screen to set the automatic gain adjustment.



Setting	Explanation
OFF	This disables automatic level adjustment. Adjust the recording level manually.
CONCERT	This is suitable for recording band performances, concerts and other loud situations.
SOLO	Use for solo performances and other quiet sounds.
MEETING	Use for meetings and field recordings.

NOTE

When automatic gain adjustment is in use, manual adjustments cannot be made using .

Recording

Recording video

1. Press .



This starts video recording.

2. Press  again to stop video recording.

NOTE

- The energy saving function will make the screen dim during recording. (→ [“Setting the display back-light time” on page 43](#))
- During video recording, the REC LED on the front lights red.
- If the internal temperature of the **Q2n-4K** rises during use, a warning message will appear and it will turn off automatically. Wait for the temperature to decrease before using it again.
- By connecting an HDMI-compatible TV or other device, you can monitor the video and audio during recording. (→ [“Viewing on an HDMI-compatible TV” on page 30](#))
- The maximum resolution of HDMI output is 1920×1080 when recording.
- When recording video, connecting or disconnecting an HDMI cable will cause video and audio recording to stop.

HINT

When recording for long periods of time with a microSDHC card, recording files will be split after 4 GB. When using a microSDXC card, recording will continue in one file even if the file size exceeds 4 GB.

Connecting external input devices

You can capture audio with an external mic or audio device when recording video or audio.

1. Connect the external mic or audio device to the external input jack.

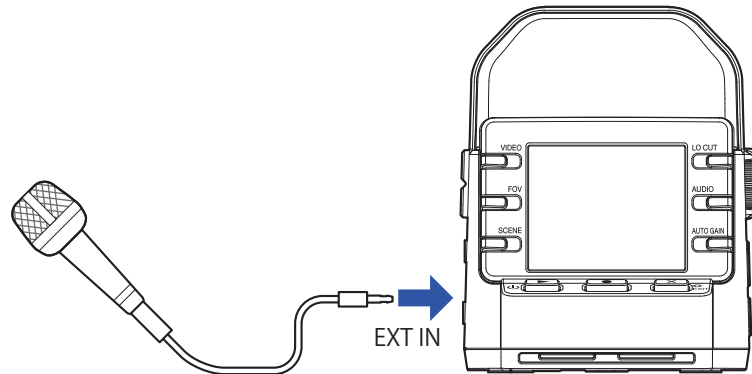

NOTE

The built-in mics are disabled when an external device is connected to the external input jack.

HINT

- This jack can provide plug-in power to mics that use it. (→ [“Using mics that support plug-in power” on page 50](#))



Playing recordings

Playback Screen overview

From the Recording Screen, press  to open the Playback Screen.



Playing recordings



1. Press   on the Recording Screen.



Playback of the last recorded file or the most recently played file will start.

NOTE





- The **Q2n-4K** can only play videos that it recorded.

2. Press   to stop playback and reopen the Recording Screen.

Playback operations

The following operations are possible during playback.

Changing the playback position

Pause/resume	Press  
Search forward	Press and hold 
Search backward	Press and hold 

Selecting files

Move to next file	Press 
Move to previous file	Press 

Playing files continuously

Playback can be set so that after playback of one file completes the next file can be played back without stopping. (→ [“Enabling continuous playback” on page 49](#))

Adjusting the output volume

1. Use  to adjust the volume.

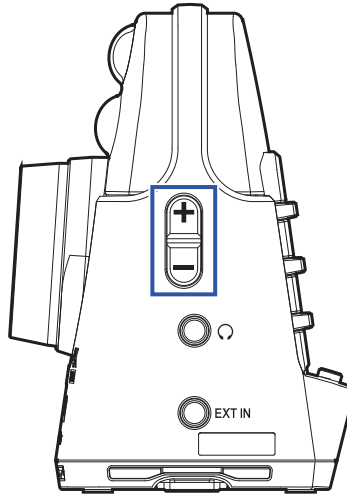

HINT

- The volume can be adjusted separately for the speaker and headphones.
- The volume can be set from 0 to 30.

Headphone/line output

You can listen to the audio with headphones or an external audio amplifier.

1. Connect headphones or audio equipment to the headphone jack using a stereo mini plug cable.

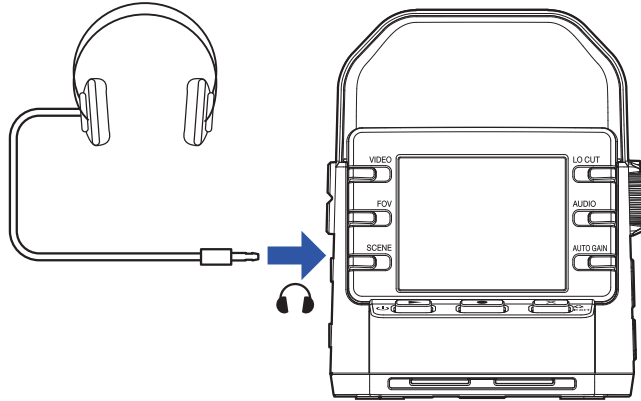

HINT

When the Recording Screen is open, you can monitor the input sound.

Viewing on an HDMI-compatible TV

Use an HDMI cable to connect with an HDMI-compatible TV to view **Q2n-4K** video recordings on it.

1. Connect an HDMI cable (not included) to the Micro HDMI connector.

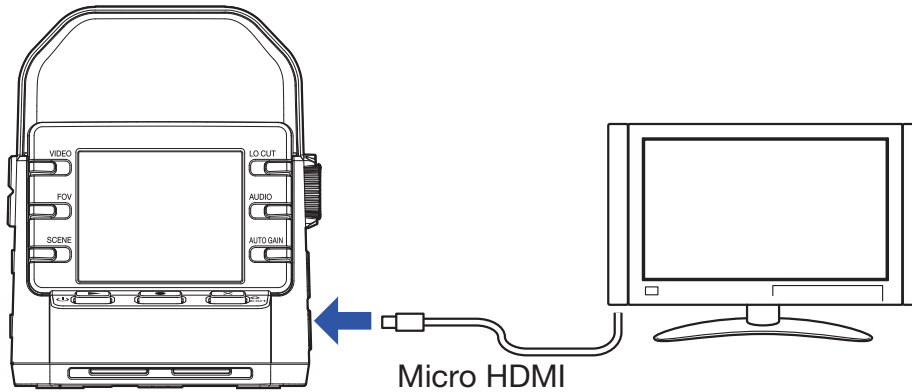

2. Press   to play the video and audio.



The display on the recorder will turn off and the recorded file will play on the TV screen.

HINT

The recorder can be operated while outputting to a TV. (→ [“Playback operations” on page 27](#))

NOTE

- During TV output, file information cannot be shown and files cannot be deleted.
- Some TVs do not support some audio formats, so correct playback might not always be possible.

Managing files

Checking file information

You can view a variety of information about the current playback file.

1. Press  on the Playback Screen.



This shows information about the current playback file.

Information about the duration, size, date, time, video and audio can be checked.

2. Press .

This reopens the Playback Screen.

Deleting files

You can delete files that you do not need.

1. Press  on the Playback Screen.



The deletion screen will open.

2. Press  to select a file.



A check will appear in the box at the top left of the file image.

HINT

You can use < and > to change files and add checks to multiple files.

3. Press .



This opens a deletion confirmation screen.

4. Press  to select **Yes** ●.



The checked files will be deleted.

To cancel deletion, press   **EXIT** to select **No x**.

Using USB functions

Connecting to computers and iOS devices

Use a USB cable to connect to a computer or iOS device and use the recorder as a web camera, card reader or USB mic.

1. Press  on the Recording Screen.



This opens the Setting Screen.

2. Press →.



This opens the USB Connection Setting Screen.

3. Press the button for the function to be used.

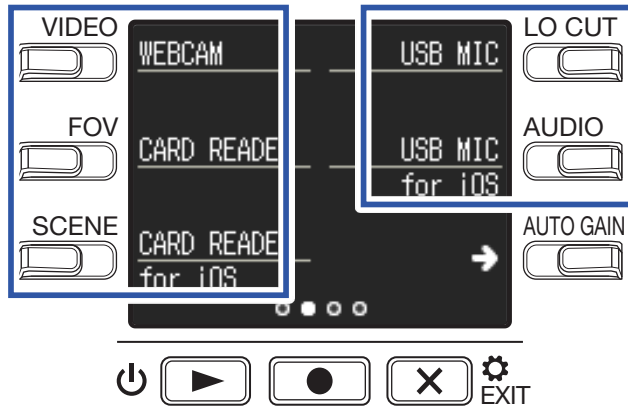

Function	Explanation
WEB Camera	Use as a web camera with a computer (→ “Using as a web camera” on page 38)
Card Reader	Use as an SD card reader with a computer (→ “Using as a card reader” on page 39)
Card reader for iOS	Use as an SD card reader with an iOS device (→ “Using as a card reader” on page 39)
USB Mic	Use as a USB mic with a computer (→ “Using as a USB mic” on page 40)
USB Mic for iOS	Use as a USB mic with an iOS device (→ “Using as a USB mic” on page 40)

4. Press on the Confirmation Screen to select **Yes** ●.

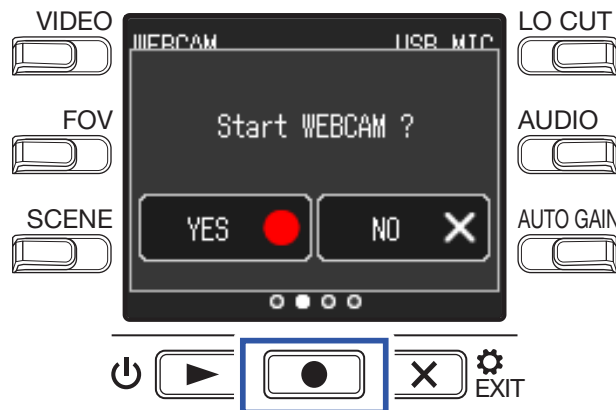

This activates the selected function.

5. Use a USB cable to connect a computer or iOS device.

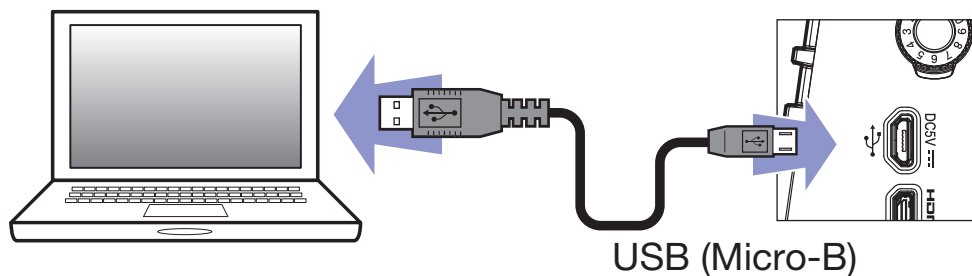

NOTE

Use a USB cable that supports data transfer.

6. To end use, press  on any function screen.

7. Press  on the Confirmation Screen to select **Yes**.

This reopens the Recording Screen.

NOTE

- When connected to a computer, power can be supplied by USB.
- When connected to an iOS device, use batteries because power cannot be supplied by USB.
- A list of iOS devices that have been confirmed to work with this unit can be checked at zoomcorp.com.
- An iPad Camera Connection Kit or Lightning to USB Camera Adapter (not included) is necessary to connect to an iOS device.

Turning the power on when connected to a computer

If the **Q2n-4K** power is turned on when connected to a computer, the USB function selection screen will open.

1. Use < and > to select the function to use.

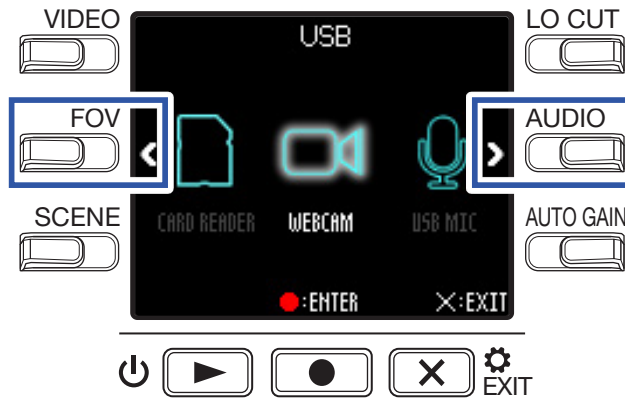

2. Press  to confirm.

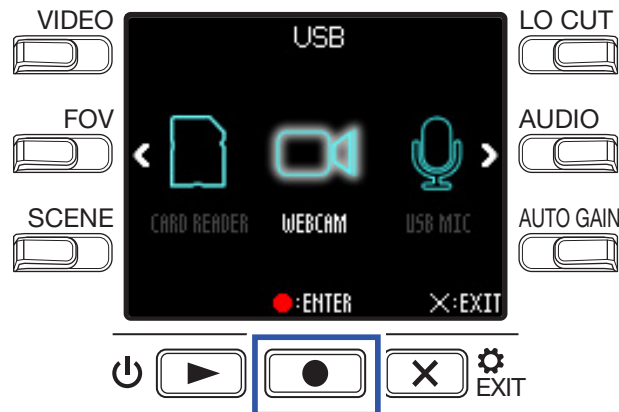

3. Press  on the Confirmation Screen to select **Yes** ●.

This activates the selected mode.

Press  to open the Recording Screen.

Using as a web camera

The **Q2n-4K** can be used as a web camera to input audio and video to a computer.

1. Connect the **Q2n-4K** with a computer.

(→ [“Connecting to computers and iOS devices” on page 34](#))

NOTE

Web camera use is not possible with an iOS device.

2. Launch an application that uses a camera on the computer, and select the **Q2n-4K**.

NOTE

- The recorder can simultaneously transmit video and audio with resolutions up to 720 p HD and 48 kHz/16-bit to a computer.
- The **Q2n-4K** cannot output computer playback signals

HINT

Refer to the manual for the application that you are using for the procedures to select the **Q2n-4K**.

3. To end the connection, conduct the necessary disconnection procedures on the computer.

Compensating for lags between video and audio

If a timing difference occurs between the video and audio when using the recorder as a web camera, you can set an audio delay time so that it matches the timing of the video.

1. During web camera use, press **DELAY**.



Press **DELAY** again repeatedly to lengthen the audio delay time.

Setting	Explanation
0.0 F	The delay time can be set in increments of 0.5 F. (1 F is 33 msec.) The maximum delay time is 10.0 F (330 msec).
↓	
10.0 F	



Using as a card reader

The **Q2n-4K** can be used as a card reader to read and write data from computers and iOS devices.

1. Connect the **Q2n-4K** to a computer or iOS device.
(→ [“Connecting to computers and iOS devices” on page 34](#))
2. Open a file management screen on the computer or iOS device and show the contents of the microSD card in the **Q2n-4K**.
3. Work with the files on the microSD card.
4. To end the connection, conduct the necessary disconnection procedures on the computer or iOS device.

HINT

Refer to the manual for the computer or iOS device that you are using for detailed operation procedures.

5. Press  **EXIT**.
6. Press  on the Confirmation Screen to select **Yes** ●.
This reopens the Recording Screen.

Using as a USB mic

The **Q2n-4K** can be used as a USB mic to input audio to a computer or iOS device.

1. Connect the **Q2n-4K** to a computer or iOS device.
(→ [“Connecting to computers and iOS devices” on page 34](#))
2. Launch an application that uses a mic on the computer or iOS device, and select the **Q2n-4K**.

HINT
Refer to the manual for the application that you are using for the procedures to select the **Q2n-4K**.

3. To end the connection, conduct the necessary disconnection procedures on the computer or iOS device.

Enabling direct monitoring

The input sound can be monitored directly during USB mic use.

1. During USB mic use, press **DIRECT MNTR**.



This turns direct monitoring ON/OFF.

Battery settings

Setting the type of battery used

Set the type of battery used so that the amount of remaining battery charge can be accurately displayed.

1. Press  on the Recording Screen.



This opens the Setting Screen.

2. Press  three times to change the Setting Screen.



3. Press **Battery Type** to set the type of battery used.



The options are **Alkaline**, **Ni-MH** and **Lithium**.

4. Press  **EXIT**.

This reopens the Recording Screen.

Enabling energy saving

Setting the display backlight time

Power can be saved by shortening the amount of time that the backlight stays lit.

1. Press  on the Recording Screen.



This opens the Setting Screen.

2. Press → three times to change the Setting Screen.



3. Press **Power Save**, and set the time until the backlight dims.



Setting	Explanation
Off	The backlight always stays bright.
1 min	The backlight dims if no operation occurs for 1 minute.
3 min	The backlight dims if no operation occurs for 3 minutes.
5 min	The backlight dims if no operation occurs for 5 minutes.

4. Press  **EXIT**.



This reopens the Recording Screen.

Setting the Auto Power Off function

Set to turn off automatically if not used at all for a set amount of time when running on battery power.

NOTE

This function is disabled during recording and playback as well as when it is powered through its USB port.

1. Press   on the Recording Screen.



This opens the Setting Screen.

2. Press → three times to change the Setting Screen.



3. Press **Auto Power Off**, and set the time until the power turns off.



Setting	Explanation
Off	The Auto Power Off function is disabled.
1 min	The power will turn off automatically 1 minute after the last operation.
3 min	The power will turn off automatically 3 minutes after the last operation.
5 min	The power will turn off automatically 5 minutes after the last operation.

4. Press  **EXIT**.

This reopens the Recording Screen.

Setting the date and time

If the date and time are set, the recorder can add the recording date and time to files.

1. Press  on the Recording Screen.



This opens the Setting Screen.

2. Press → two times to change the Setting Screen.



This opens the Date and Time Setting Screen.

3. Press the button for the item to be set.

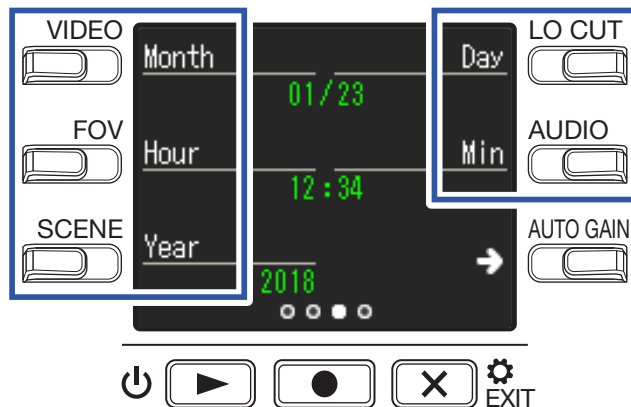

4. Press .

This reopens the Recording Screen.

Setting the volume of the operation sound

Set the volume of the **Q2n-4K** operation sound.



1. Press  on the Recording Screen.

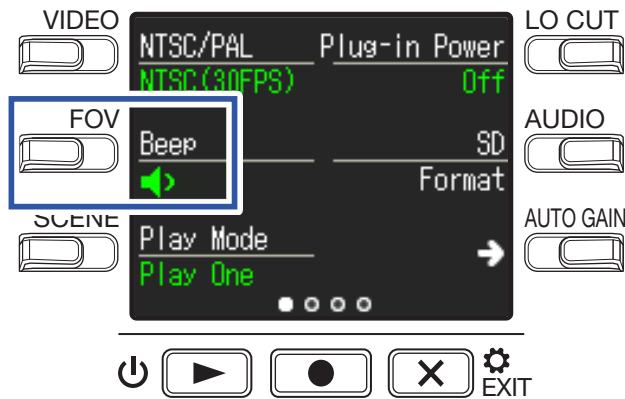

This opens the Setting Screen.

2. Press **Beep**, and set the volume.



Setting	Explanation
	No operation sound is output.
	A low-volume operation sound is output.
	A high-volume operation sound is output.

3. Press .

This reopens the Recording Screen.

Enabling continuous playback

Playback can be set so that after playback of one file completes the next file can be played back without stopping.

1. Press  on the Recording Screen.



This opens the Setting Screen.

2. Press **Play Mode**, and set whether continuous playback is enabled.



Setting	Explanation
Play One	Playback stops after one file completes playing.
Play All	After one file completes playing, the next file plays back without stopping. Files will play back in the order of the time they were recorded. Playback will stop after the most recent file completes playing.

3. Press .

This reopens the Recording Screen.

Using mics that support plug-in power

Enable plug-in power from the **Q2n-4K** for mics that support it.

1. Press  on the Recording Screen.



This opens the Setting Screen.

2. Press **Plug-in Power** and set it to **On**.



3. Press .

This reopens the Recording Screen.

Setting the standard frame rate

This sets the standard recording frame rate used according to the regional video format.

1. Press  on the Recording Screen.



This opens the Setting Screen.

2. Press **NTSC/PAL** to set the standard frame rate.



Setting	Explanation
NTSC (30 FPS)	The standard frame rate for the NTSC format is used for recording.
PAL (25 FPS)	The standard frame rate for the PAL format is used for recording. The VIDEO setting options will change to 4K-25 VIDEO , 1080-50 SMOOTH , 1080-25 VIDEO and 720-25 VIDEO .

3. Press .

This reopens the Recording Screen.

Setting the language shown

Set the language shown on the display.

1. Press  on the Recording Screen.



This opens the Setting Screen.

2. Press \rightarrow three times to change the Setting Screen.

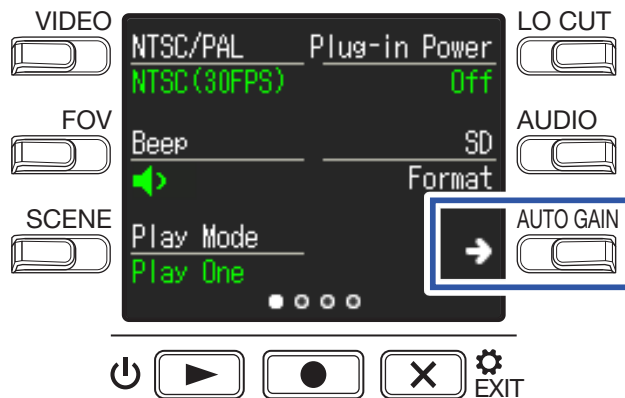

3. Press **Language**.



This changes the display language.

4. Press .

This reopens the Recording Screen.

Formatting microSD cards

To maximize the performance of a microSD card, use the **Q2n-4K** to format it.

1. Press  on the Recording Screen.



This opens the Setting Screen.

2. Press **SD Format**.

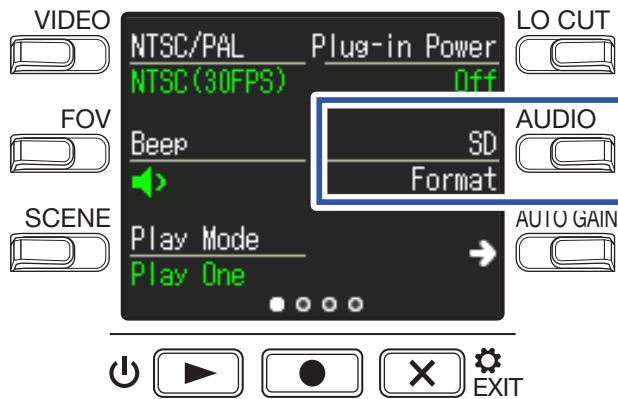

This opens a formatting confirmation screen.

3. Press  to select **Yes**.

This will start microSD card formatting.

"Done" will appear on the display when formatting completes.

NOTE

- After purchasing a new microSD card, always format it using the **Q2n-4K**.
- All data previously saved on the microSD card will be deleted when it is formatted.

Restoring factory default settings

You can restore all **Q2n-4K** settings to their factory defaults.

1. Press  on the Recording Screen.



This opens the Setting Screen.

2. Press \rightarrow three times to change the Setting Screen.



3. Press **Setting Reset**.



This opens a reset confirmation screen.

4. Press  to select **Yes** .

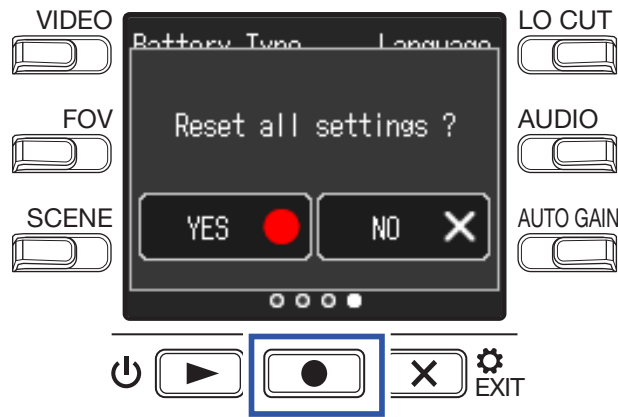

This starts resetting the **Q2n-4K**.

After resetting completes, the power will automatically turn off.



Updating the firmware

The **Q2n-4K** firmware can be updated to the latest versions.

1. Install new batteries in the **Q2n-4K** or connect an AC adapter.

NOTE

Executing a firmware update is not possible if the remaining battery power is low.

2. Copy the firmware update file to the root directory on a microSD card.
The latest firmware update file can be downloaded from zoomcorp.com.
3. Insert the microSD card into the microSD card slot.
4. While pressing , press  to turn the power on.

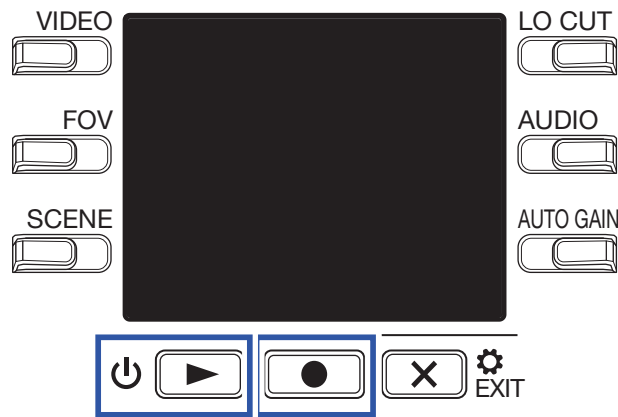

This opens an update confirmation screen.

5. Press  to select **Yes** ●.

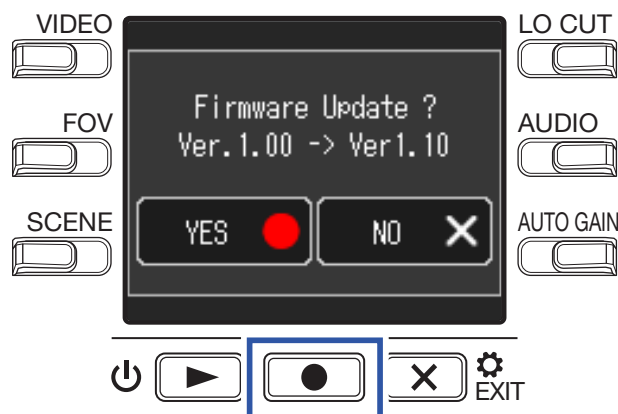

This opens a final confirmation screen.

6. Press  to select **Yes** .

After updating completes, a notification screen appears.

NOTE



Do not turn the power off during a firmware update.

7. Press and hold  to turn the power off.

Responding to warning messages

If one of the warning messages below appears, follow the instructions to respond to it.





Warning messages that appear during startup

Message	Explanation and response
 Date and Time were Reset	The date and time setting were initialized. Reset the time. (→ “Setting the date and time” on page 15)
 File recovery failed.	Data recording was not completed properly, so the unit tried to recover it but recovery failed.



Warning message that appear when using batteries

Message	Explanation and response
 Low Battery !	The remaining battery charge has become low. Replace the batteries with new ones.

Warning messages that appear when the Recording Screen is open

Message	Explanation and response
 No SD Card !	No microSD card is loaded. Load a microSD card.
 Low Speed Card !	Recording stopped because the writing speed to the microSD card was insufficient. Use a microSD card that has been formatted by the Q2n-4K and confirmed to work with it. Please check the list of cards that have been confirmed to work on the ZOOM website (zoomcorp.com).
 Card Full !	The microSD became full. Delete unneeded data or replace it with a new microSD card.
 Too Hot! Shutting down.	The power will turn off because the temperature inside the unit has become high. Wait for the temperature to decrease before using it again.

Warning messages that appear when the Playback Screen is open

Message	Explanation and response
 Invalid File !	The file is invalid. Files cannot be played if they were not created by the Q2n-4K or they are invalid because recording did not stop properly.
 Pickup Full !	The number of files with check marks for deletion exceeded the maximum (999). Reduce the number of checks.
 Read Only !	The file is protected so it could not be deleted. Check the file characteristics on a computer.

Troubleshooting

If you think that the **Q2n-4K** is operating strangely, check the following items first.

Recording/playback trouble

■ It becomes warm

- The unit and the microSD card might become warm but this is not a malfunction.

■ There is no sound or it is very quiet

- Check the connections with connected devices and their volume settings.
- Confirm that the output volume is not set low.

■ Recorded sound cannot be heard or is very quiet

- Check the recording level setting. (→ [“Adjusting recording levels” on page 21](#))
- If a CD player or other device is connected to an input jack, raise the output level of that device.

■ Recording audio/video is not possible

- Checked the remaining recordable time on the Recording Screen. (→ [“Recording Screen overview” on page 16](#))

■ A “Low Speed Card!” warning appears frequently/Stopping recording takes a very long time

- microSD cards can become worn out. Speed can decrease after repeated writing and erasing.
- Formatting the card with the **Q2n-4K** might improve this. (→ [“Formatting microSD cards” on page 53](#))
- If formatting a microSD card does not improve this, we recommend replacing the card. Please check the list of cards that have been confirmed to work on the ZOOM website (zoomcorp.com).

NOTE

This is not a guarantee of specific microSD card recording performance for microSD cards that have been confirmed to work.

This list is provided as a guideline to help find suitable cards.

Specifications

Image sensor	1/2.3" 16 M-pixel CMOS sensor			
Lens	F 2.8, 150° FOV			
Video format	MPEG-4 AVC/H.264 (MOV)			
Video resolutions	4K: 30 p, 25 p, 24 p 1080: 60 p, 50 p, 30 p, 25 p, 24 p 720: 30 p, 25 p			
Audio formats	WAV: 96 kHz/24-bit, 48 kHz/24-bit, 44.1 kHz/16-bit			
Audio functions	<ul style="list-style-type: none"> · LO CUT: OFF, 80 Hz, 120 Hz, 160 Hz · AUTO GAIN: OFF, CONCERT, SOLO, MEETING · DELAY: 0.0 F, 0.5 F–10.0 F (only during web camera use) · DIRECT MONITOR ON/OFF (only during USB mic use) 			
Image functions	<ul style="list-style-type: none"> · FOV: WIDE · 0 · TELE (5 steps) · SCENE: AUTO, OUTDOOR, SUNSET, NIGHT, CONCERT LIGHT, JAZZ CLUB, DANCE CLUB, MONOCHROME, SEPIA, FILM, X-PROCESS, FLAT 			
Display	1.77" full-color LCD (160 × 128)			
Audio inputs	Mic	Fixed 120° XY stereo mic Maximum sound pressure: 120 dB SPL Input gain: $-\infty$ dB – +39 dB		
	Line	Input connector: stereo mini jack (supports plug-in power) Input gain: $-\infty$ dB – +39 dB 2 k Ω or higher input impedance Plug-in power (2.5 V) supported		
Output connector	Combined headphone/line stereo mini jack HDMI micro Type D			
Built-in speaker	300 mW 8 Ω mono speaker			
Recording media	microSD / microSDHC / microSDXC (256 GB maximum)			
USB	micro USB <ul style="list-style-type: none"> • Use a USB cable that supports data transfer. USB bus power is supported. WEBCAM Class: UVC 1.0 + UAC 1.0 Formats: 720 p WVGA video 48 kHz/16-bit audio CARD READER Class: USB Mass Storage USB MIC Class: UAC 1.0 Format: 44.1 kHz/16-bit Note: card reader and USB mic functions support iOS devices			
Power	2 AA batteries : alkaline LR6 (1.5 V), nickel metal hydride HR6 (1.2 V) or lithium FR6 (1.5 V) AC adapter (ZOOM AD-17): DC 5 V/1 A Note: USB bus power supported			
Estimated continuous recording time using batteries	Video resolution	Alkaline LR6 (1.5 V)	Ni-MH HR6 (1.2 V)	Lithium FR6 (1.5 V)
	720/30 p	2.0 hours	3.0 hours	6.0 hours
	1080/30 p	1.2 hours	2.0 hours	4.0 hours
	4K/30 p	0.5 hours	1.0 hours	2.0 hours
	Audio quality: 48 kHz/24-bit <ul style="list-style-type: none"> • The above values are approximate. • Continuous battery operation times were determined using in-house testing methods. They will vary greatly according to use conditions. 			
External dimensions	Main unit (maximum dimensions): 58.7 mm (D) × 68.5 mm (W) × 83.0 mm (H)			
Weight (including batteries)	170 g			



4-4-3 Kanda-surugadai, Chiyoda-ku, Tokyo 101-0062 Japan
zoomcorp.com