

ZOOM®

H4n Pro Handy Recorder

OPERATION MANUAL

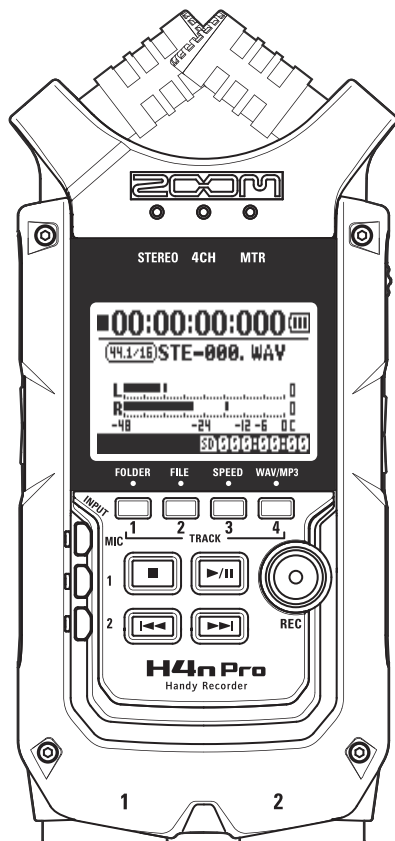

© 2021 ZOOM CORPORATION

Copying or reprinting this manual in part
or in whole without permission is prohibited.

H4n Pro features

Thank you very much for purchasing our ZOOM H4n Pro Handy Recorder. The H4n Pro has the following special features.

- **An all-in-one handy recorder.**

The H4n Pro is lightweight (294 g) with a very compact design and is equipped with high quality stereo condenser microphones arranged in an XY pickup pattern, a built-in speaker, SD card recording, a mixer and internal effects.

You can enjoy recording and creating your own music anytime, anywhere with the H4n Pro.

- **Versatile field recorder with multi-track capability.**

The H4n Pro is capable of recording in several different operation modes. STEREO mode enables high-quality stereo recording. 4CH mode can record 2 sound sources simultaneously in stereo. MTR mode allows playback of 4 tracks and recording of 2 tracks simultaneously. You can use it as a field recorder to record melodies and band performances on-the-fly and to capture sound effects. You can also use it as a multitrack recorder to make songs by overdubbing instruments and vocals. Furthermore, in STAMINA mode you can record in stereo for up to 11 hours using batteries only.

- **New 90/120°-variable XY stereo mic**

The H4n Pro allows you to adjust the angle of the onboard microphones to address a wider range of recording scenarios. Set the microphones to 120° for a wider area of sound, or set them to 90° for a more focused sound source. Either way, the mics retain their XY configuration, so you can record natural stereo sound with no phase cancellation.

- **Connect mics and guitars directly using combined XLR/standard phone jacks**

The H4n Pro includes input jacks for connections that can accommodate a variety of recording styles. Microphones, including stereo mics and condensers, electric guitars, basses and keyboards can all be connected directly.

- **Use as an audio interface and SD card with a computer**

An onboard USB 2.0 Hi-Speed port allows direct connection to a computer. You can use it as an audio interface with built-in effects (sampling rate limited to 44.1 kHz when using the effects). You can also use the H4n Pro as an SD card reader for your computer. You can transfer recorded files to your computer and use them to create audio CDs or work with them in DAW software.

- **Tuner, metronome, karaoke and various other functions**

The tuner functions include not only a standard chromatic tuner, but also support less common tunings, such as for 7-string guitars and 5-string basses. The metronome function is convenient for practice and multitrack recording. You can also use the H4n Pro as a practice device.

Use the SPEED function to adjust the playback speed from 50–150%. The KARAOKE functions include center canceling for stereo files and variable key control, making it valuable for language learning and voice training.

Please read this manual carefully to fully understand the functions of the H4n Pro so that you can make the most of it for many years. After reading this manual, please keep it with the warranty in a safe place.

The H4n Pro is ideal for these applications



Vocal recording



Recording acoustic guitars



Piano recitals



Recording live performances



Band practices



Transferring analog sound sources to digital



Recording meetings



Field recording



Drum practice recording

Contents

H4n Pro features	001
The H4n Pro is ideal for these applications.....	002
Contents.....	003
Safety precautions for users	006
Copyright warnings	007

Getting started

1-1	Recording flow using the H4n Pro	009
1-2	Easy recording guide (STEREO mode)	011
2-1	Names and functions of parts.....	013
3	Battery/Power setting	015
4-1	Using the POWER/HOLD switch and turning the power on/off.....	017
4-2	Using recording and transport buttons.....	019
4-3	Using TRACK 1–4 buttons.....	020
4-4	Using INPUT MIC, 1 and 2 buttons	021
4-5	Using REC LEVEL and VOLUME buttons.....	022
4-6	Using the DIAL and the MENU button.....	023
5-1	Loading an SD card	025
5-2	Setting the date and time (DATE/TIME)	026
6-1	Setup: Connecting external devices	027
6-2	Setup: Built-in microphones	028
6-3	Setup: Built-in microphones/external mic with plug-in power.....	029

6-4	Setup: INPUT 1/2 connections and phantom power.....	030
6-5	Using as a USB audio interface	031
6-6	Setup: Using as a USB SD card reader	033
6-7	Setup: Built-in speaker	034
7-1	Mode overview.....	035
7-2	Switching and confirming modes	036
7-3	Mode details	037
8-1	Mode screens: STEREO and STAMINA modes.....	038
8-2	Mode screens: 4CH mode.....	039
8-3	Mode screens: MTR mode	040
8-4	Mode screens: MAIN MENU.....	041
9	Optional remote control operation.....	043

Operations

1-01	Settings/recording: Setting input sources and recording levels....	045
1-02	Settings/recording: Recording in STEREO and STAMINA modes ...	047
1-03	Settings/recording: Recording format (REC FORMAT)	049
1-04	Settings/recording: File name (FILE NAME).....	050
1-05	Settings/recording: 4CH mode recording.....	051
1-06-1	Settings/recording: MTR mode recording (REC MODE)	053
1-06-2	Settings/recording: MTR mode recording (OVER WRITE).....	055
1-06-3	Settings/recording: MTR mode recording (ALWAYS NEW).....	056

1-07	Settings/recording: TRACK MENU	057	3-03-5	EFX module editing (EFFECT EDIT: EFX).....	086
1-08-1	Settings/recording: Automatic re-recording (PUNCH IN/OUT)	059	3-03-6	EFFECT EDIT: LEVEL/RENAME.....	087
1-08-2	Settings/recording: Manual re-recording (PUNCH IN/OUT)	061	3-03-7	EFFECT EDIT: STORE	088
2-01-1	Recording functions: AUTO REC.....	063	3-03-8	Importing patches from other projects (EFFECT IMPORT)	089
2-01-2	Recording functions: AUTO REC STOP	064	3-04-1	Karaoke preparation (KARAOKE).....	091
2-02	Recording functions: PRE REC.....	065	3-04-2	Karaoke recording (KARAOKE).....	093
2-03	Recording functions: LO CUT.....	066	4-01	Playback: File Playback (STEREO, 4CH and STAMINA modes) ...	094
2-04	Recording functions: COMP/LIMIT.....	067	4-02	Playback: PLAY MODE.....	095
2-05	Recording functions: REC LEVEL AUTO	069	4-03	Playback: Setting marks	096
2-06	Recording functions: MONITOR	070	4-04	Playback: AB REPEAT.....	097
2-07	Recording functions: INPUT 1/2 LEVEL LINK.....	071	4-05	Playback: SPEED.....	099
2-08	Recording functions: MONO MIX	072	4-06	Playback: MIXER.....	100
2-09	Recording functions: MS STEREO MATRIX	073	4-07	Playback: Playing files (MTR mode).....	101
3-01-1	Tuner: CHROMATIC TUNER.....	075	4-08	Playback: Specifying a counter time	102
3-01-2	Tuner: other TUNER types.....	076	5-01	Editing/Output: FOLDER SELECT	103
3-01-3	Tuner: TUNER CALIB.....	077	5-02	Editing/Output: FILE SELECT	104
3-01-4	Tuner: TUNER INPUT.....	078	5-03	Editing/Output: FILE INFORMATION	105
3-02	Metronome (METRONOME).....	079	5-04	Editing/Output: FILE DELETE	106
3-03-1	Effects overview.....	081	5-05	Editing/Output: FILE DELETE ALL.....	107
3-03-2	Effects (EFFECT).....	083	5-06	Editing/Output: FILE COPY.....	108
3-03-3	Patch editing (EFFECT EDIT)	084	5-07	Editing/Output: FILE RENAME.....	109
3-03-4	PRE AMP module editing (EFFECT EDIT: PRE AMP).....	085	5-08	Editing/Output: FILE MP3 ENCODE	111

5-09	Editing/Output: FILE NORMALIZE	112
5-10	Editing/Output: FILE STEREO ENCODE.....	113
5-11	Editing/Output: MARK LIST	115
5-12	Editing/Output: DIVIDE	116
5-13	Editing/Output: MOVE	117
5-14	Editing/Output: NEW PROJECT	118
5-15	Editing/Output: PROJECT SELECT	119
5-16	Editing/Output: PROJECT DELETE	120
5-17	Editing/Output: PROJECT RENAME.....	121
5-18	Editing/Output: PROJECT COPY	122
5-19	Editing/Output: PROJECT BOUNCE	123
5-20	Editing/Output: PROJECT PROTECT	125
6-01	Utilities: DISPLAY BACK LIGHT	126
6-02	Utilities: MEMORY REC	127
6-03	Utilities: DISPLAY CONTRAST	129
6-04	Utilities: BATTERY TYPE.....	130
6-05	Utilities: VERSION	131
6-06	Utilities: FACTORY RESET.....	132
6-07	Utilities: REMAIN.....	133
6-08	Utilities: FORMAT.....	134
6-09	Utilities: VERSION UP	135
6-10	Utilities: Using H2 and H4 SD cards	136

Reference

Main specifications by mode	139
Settings available in each mode.....	140
MTR mode effect types and parameters.....	141
H4n Pro patch list.....	147
H4n Pro specifications	149
Troubleshooting	150
Index	151

Safety precautions for users

SAFETY PRECAUTIONS

In this manual, warning and caution symbols are used to highlight dangers of accidents and troubles. Users should read them to prevent accidents. The meanings of these symbols are as follows:



Warning

If the users ignore this symbol and handle the device the wrong way, serious injury or death could result.



Caution

If the users ignore this symbol and handle the device the wrong way, bodily injury and damage to the equipment could result.



An action that is mandatory



An action that is prohibited

Please read through the following safety tips and precautions to ensure hazard-free use of the H4n Pro.

Power requirements



Warning

AC adapter operation

- ❶ Make sure to use only a DC5 center plus 1A (ZOOM AD-14) AC adapter. The use of other than the specified type could damage the unit and pose a safety hazard.

Connect the AC adapter only to an AC outlet that supplies the rated voltage required by the adapter.

- ❷ When disconnecting the AC adapter from the AC outlet, make sure to grasp the adapter itself. Never pull on the cable.
- ❸ During lightning or when not using for an extended period, disconnect the AC adapter from the AC outlet.

Battery operation

- ❶ Use 2 commercially-available 1.5V AA batteries (alkaline dry cell batteries or nickel metal hydride batteries).

- ❶ When not using for an extended period, remove the batteries from the unit.
- ❷ If battery leakage has occurred, wipe the battery compartment and battery terminals carefully to remove all remnant of battery fluid.
- ❸ When using the unit, the battery compartment cover should be closed.
- ❹ Install batteries with the correct +/- orientations.
- ❺ Do not use new and old batteries together. Do not use batteries of different brands or types together.



Caution

Environment



Warning

- ❶ To prevent unexpected troubles and malfunctions, avoid using the H4n Pro in environments where it will be exposed to:
 - Extreme temperatures
 - Heat sources such as radiators or stoves
 - High humidity or moisture
 - Excessive dust or sand
 - Excessive vibration or shock

Handling



Caution

- ❶ The H4n Pro is a precision instrument. Do not exert undue pressure on the keys and other controls. Take care not to drop or bump it, and do not subject it to shock or excessive pressure, which can cause serious trouble.
- ❷ Take care that no foreign objects (coins, pins, etc.) or liquids (water, alcoholic drinks or juice) enter the unit.
- ❸ Do not place the H4n Pro speaker close to other precision instruments (watches and computers), electronic medical instruments or magnetic cards.

Connecting cables and input and output jacks



Caution

- ❶ You should always turn off the power to the H4n Pro and all other equipment before connecting or disconnecting any cables. Make sure to disconnect all connection cables and the power cord before moving the H4n Pro.

Alterations



Warning

- ❶ Never open the case of the H4n Pro or attempt to modify the product in any way since this could result in damage to the unit.

Volume



Caution

- ❶ Do not use the H4n Pro at a loud volume for a long time since this could cause hearing impairment.

USAGE PRECAUTIONS

Electrical interference

For safety considerations, the H4n Pro has been designed to provide maximum protection against the emission of electromagnetic radiation from inside the device, and protection from external interference. However, equipment that is very susceptible to interference or that emits powerful electromagnetic waves should not be placed near the H4n Pro, as the possibility of interference cannot be ruled out entirely. With any type of digital control device, the H4n Pro included, electromagnetic interference could cause malfunction and could corrupt or destroy data. Care should be taken to minimize the risk of damage.

Cleaning

Use a soft, dry cloth to clean the H4n Pro. If necessary, slightly moisten the cloth. Do not use abrasive cleanser, wax, or solvents (such as paint thinner or cleaning alcohol), since these may dull the finish or damage the surface.

Breakdown and malfunction

If the unit becomes broken or malfunctions, immediately disconnect the AC adapter, turn the power off and disconnect other cables. Contact the store where you bought the unit or ZOOM service with the following information: product model, serial number and specific symptoms of breakdown or malfunction, along with your name, address and telephone number.

Please keep this manual in a convenient place for future reference.

Copyright warnings

■ Recording of live performances

Many artists and most live venues do not allow recording and photography and will check for cameras and recorders at the entrance. Even if recording is allowed, it is prohibited to sell, distribute, or upload to the Internet without the organizers authorization. Copyright violation is a crime.

■ Music CDs and downloaded sound sources

Using music recorded on CDs and other media as well as downloaded sound sources for purposes other than personal enjoyment (including, for example, playing them in a concert hall or other location and altering songs) could be a violation of copyright laws.

Zoom Corporation will not assume any responsibility related to infringements of copyrights.

Trademarks:

- The SD and SDHC logos are trademarks.

- MPEG Layer-3 audio compression technology is licensed from Fraunhofer IIS and Sivel S.p.A.
- Windows®, Windows® 10, Windows®8, Windows® 7 and Windows Vista® are trademarks or registered trademarks of Microsoft® Corporation.
- Macintosh and Mac OS are trademarks of Apple Inc.
- Other product names, registered trademarks and company names in this document are the property of their respective companies.

For the purpose of improvement, product specifications and appearance are subject to change without notice.

Getting started

1-1 Recording flow using the H4n Pro

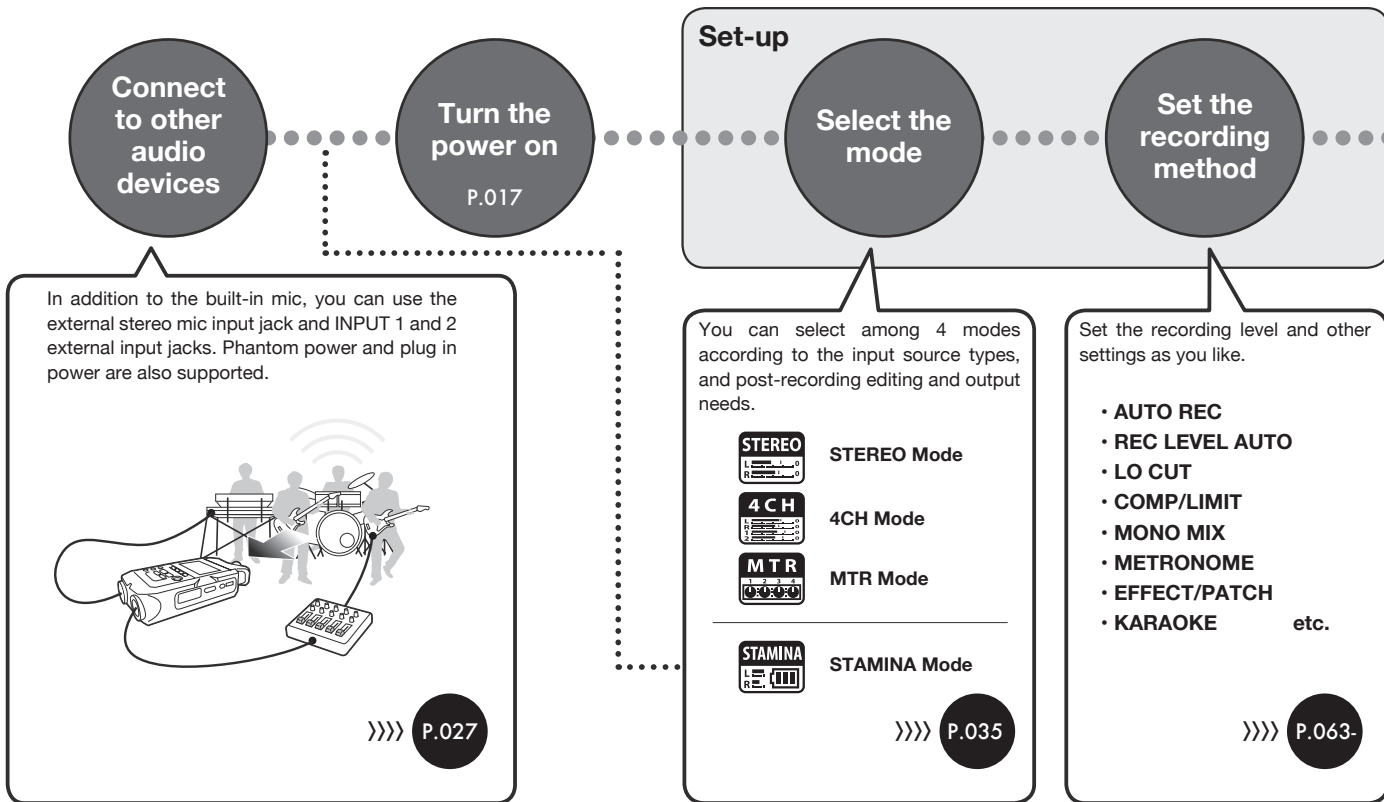
The following is the basic flow of recording operations for the H4n Pro. Depending on the recording application, you can select which recording mode and audio quality setting is right for the situation.



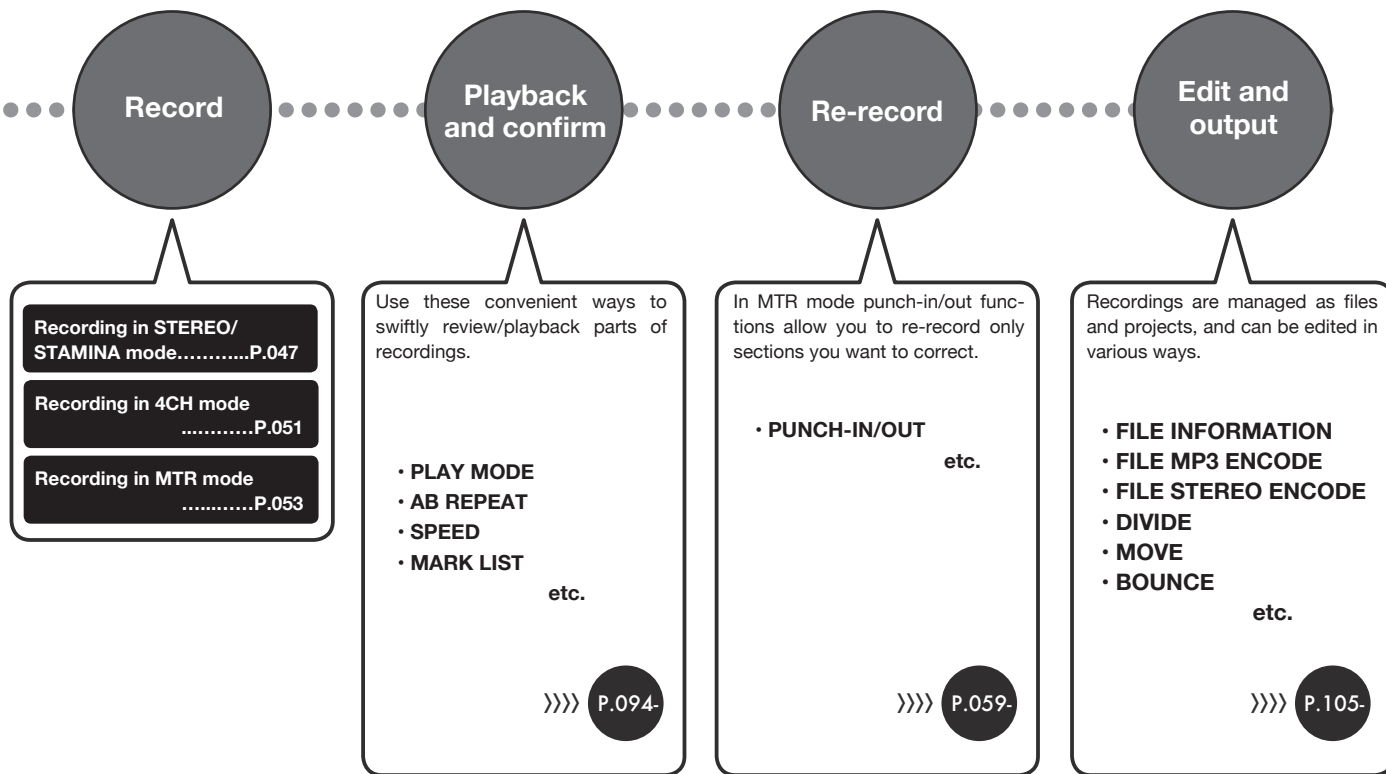

1-2 Easy recording guide (STEREO mode)

The following are basic recording instructions using the built-in stereo mic and built-in speaker in STEREO mode.

1

Turn the power on

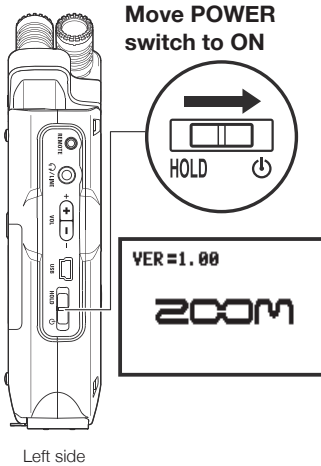

2

Confirm stereo mode



If mode indicator or screen different >>> P.036

3

Start recording standby

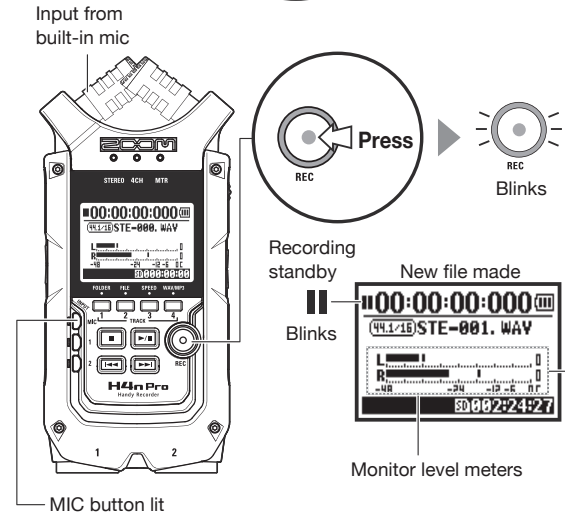

4

Adjust input level

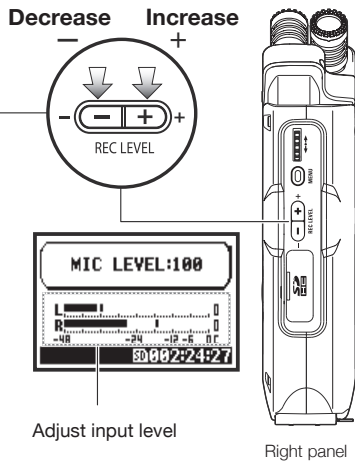

5

Start recording

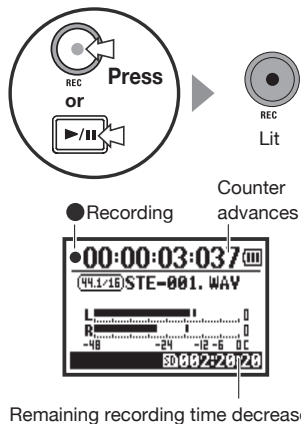

- Pause/resume recording**
Counter does not return to 0
- Add mark**
Add a mark when using WAV file format

6

Stop recording



Stereo mode recording >>>> P.047

7

Play it back

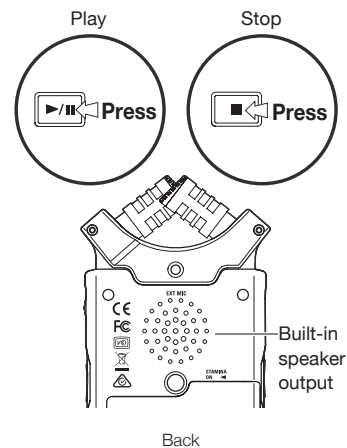

Stereo mode playback >>>> P.094

2-1 Names and functions of parts

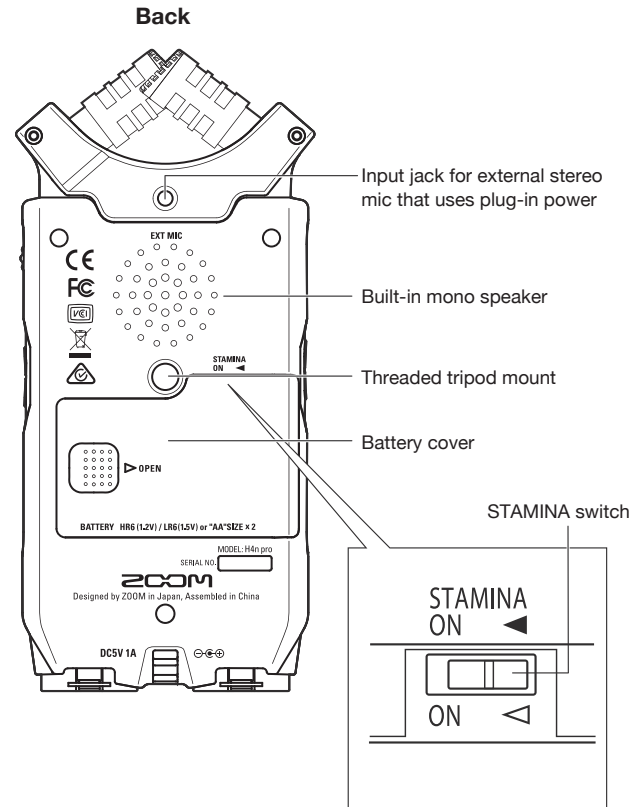
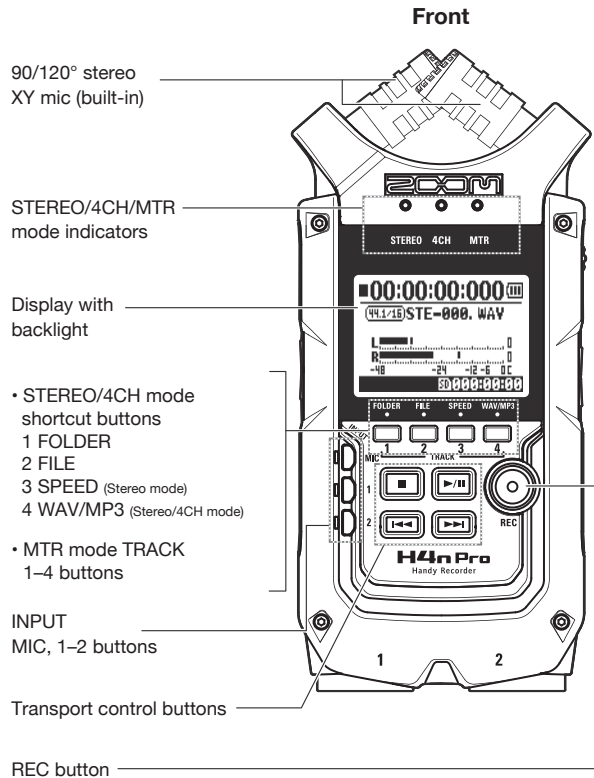

Right side

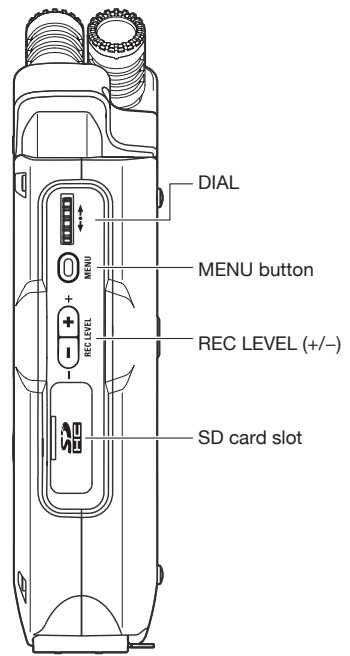

Left side

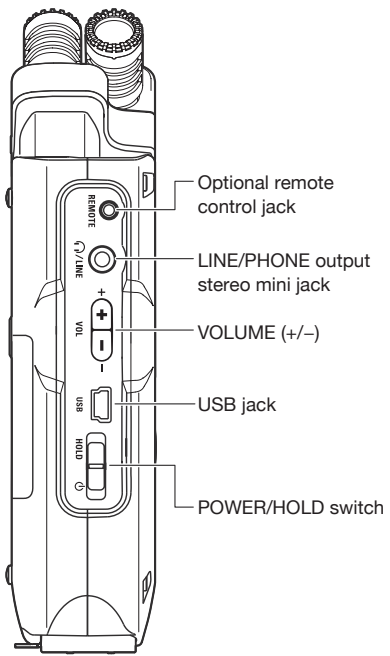

Bottom

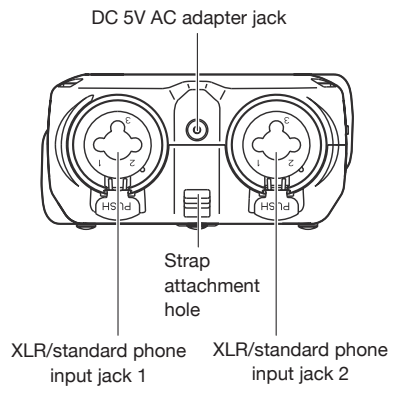

3 Battery/Power setting

The H4n Pro can be powered by a standard power outlet or batteries.

• Using a standard power outlet

Always use the specified AC adapter.

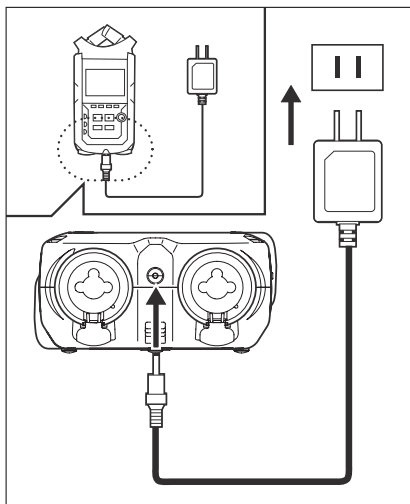

Specified AC adapter:
ZOOM AD-14

Use of an AC adapter other than the specified model could cause malfunction.

• Using batteries

Install two AA batteries.

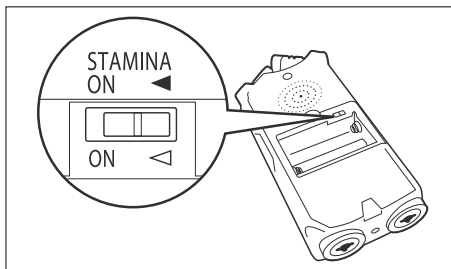
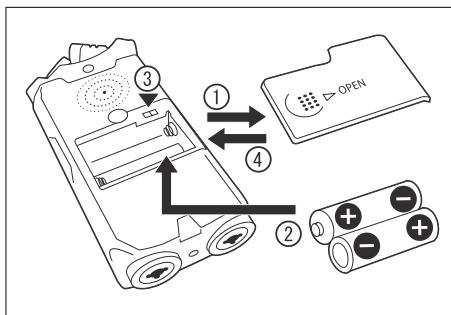

1 Open the battery compartment cover.

NOTE:

Make sure the power is off!

Confirm that the power is off whenever you open the battery compartment cover or connect/disconnect the AC adapter. Failure to do so could damage recording data.

2 Insert the batteries. (Follow the +/- orientation.)

3 Set the STAMINA switch.

◀ Ordinary use
(using AC adapter or batteries)

ON: STAMINA mode on
(conserves power when using batteries)

4 Close the battery compartment cover.

• Remaining battery charge

When a “Low Battery!” warning appears, immediately turn the unit off and replace the batteries, or switch to an AC adapter.

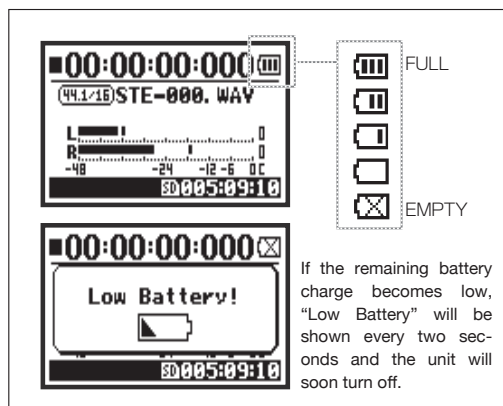

NOTE:

Usable batteries

You can use conventional alkaline and nickel metal hydride rechargeable batteries.

Power supply from USB

Connect a USB cable that is already connected to the computer to the unit while it is off. Power will be supplied by USB bus power and the unit will turn on automatically. This function is only available when the H4n Pro is used as an SD card reader or an audio interface.

HINT:

To measure the battery charge accurately

The remaining battery charge can be measured more precisely by using the H4n Pro battery type setting.

Date and time setting retention

If the batteries die or the power supply is interrupted, the H4n Pro will retain the date and time setting for about three minutes. After this, these settings will be reset to their default values.

Power supply indicator



Using batteries



Using AC adapter

Ref. USB bus power P.033

Ref. Battery type P.130

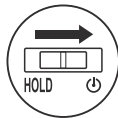
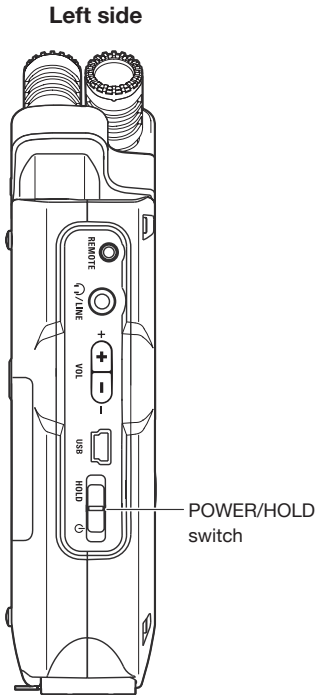

4-1 Using the POWER/HOLD switch and turning the power on/off

Turning the power on and starting up

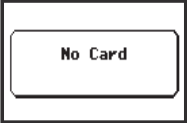

- 1 Turn all connected equipment off first.
- 2 Insert an SD card.
- 3 Slide the POWER switch to turn the power on and start up.

- 4 Turn connected instruments and monitoring equipment on in that order.

NOTE:

- Before turning the power on, lower the volume of instruments and monitors connected to the H4n Pro.
- If the display reads “No Card” when starting up, make sure that an SD card is inserted correctly.

- If the display says “Reset DATE/TIME” when starting up, the date and time have been set to their default values.

Ref.  P.026
Date and time setting

HINT: Turning multiple devices on

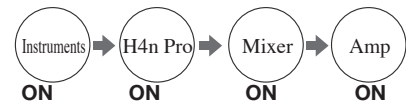
When many devices are connected, turn them on in the following order.



Turning the power off and shutting down

- 1** Turn the monitoring system and connected instruments off in that order first.
- 2** Slide the POWER switch to turn the power off.

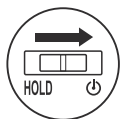

HINT: Order for turning off equipment

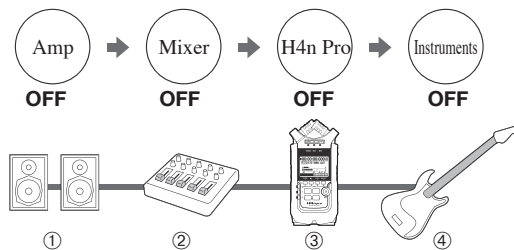

HOLD Function

The H4n Pro features a HOLD function that disables button operation to prevent misoperation during recording.

Activating the HOLD function

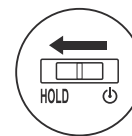

Slide the POWER switch toward HOLD.



If you press any button while HOLD is active, the screen will display “Key Hold” for two seconds. To deactivate HOLD, slide the POWER switch away from HOLD.

4-2 Using recording and transport buttons

The functions of the REC, STOP, PLAY/PAUSE, FF and REW buttons depend on the mode.

Front

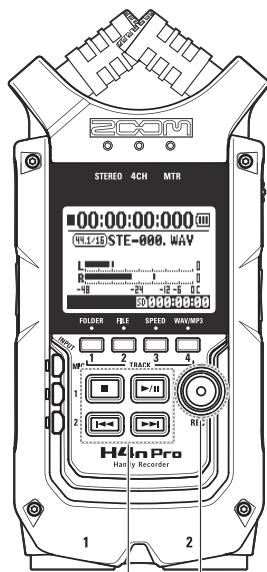

REC button

Transport buttons

STEREO/4CH/STAMINA modes



REC button

- Stopped** Enter recording standby and reset counter
- Recording standby** Start recording and counter
- Recording** **Playing** Add mark (WAV files only)

Transport buttons



STOP button

- Recording/recording standby/paused** Stop recording and reset counter
- Playing/paused** Stop playback and stop counter



PLAY/PAUSE button

- Stopped** Start playback and start counter
- Recording/paused** Resume paused recording
- Recording standby** Start recording and counter
- Playing/paused** Resume paused playback



FF/REW buttons

- Stopped** **Press for less than a second**
- Playing** FF: Show next file
REW: Return to file beginning (if there are marks, FF and REW jump to the nearest mark)

Press for more than a second
Search forward/backward
The longer the button is pressed, the faster the search speed. Searching will stop at the beginning or end of the file.

MTR mode



REC button

(Only when a track is in recording standby)

OVER WRITE recording

- Stopped** Enter recording standby
- Recording/standby** Stop recording (playback continues)
- Playing** Recording starts and counter continues

ALWAYS NEW recording

- Stopped** Enter recording standby and reset counter
- Recording standby** Start recording and start counter

Transport buttons



STOP button

- Recording** Stop recording and stop counter
- Playing** Stop playback and stop counter
- Recording paused** **Playback paused** Stop recording/playback



PLAY/PAUSE button

- Stopped** Start playback
- Recording** Pause recording (only when ALWAYS NEW recording)
- Recording standby** Start recording and counter
- Playing** Resume paused playback



FF/REW button

- Stopped** **Press for less than a second**
- Playing** FF: Skip forward one second
REW: Return to beginning
- Playback paused** **Press for more than a second**
Search forward/backward

4-3 Using TRACK 1-4 buttons

The of TRACK 1-4 buttons have different functions depending on the MODE.

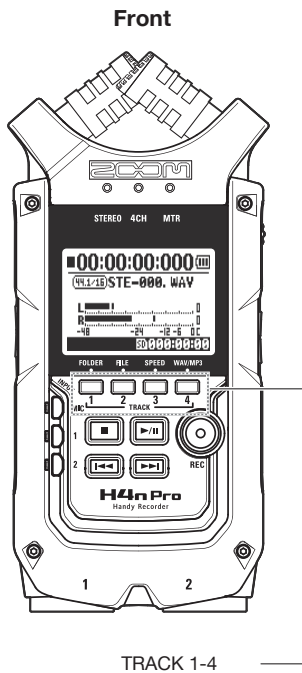

Front

TRACK 1-4

MTR MODE

Switch between track recording and playback.

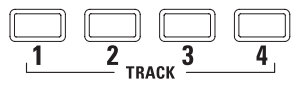

When you start recording, press the track number you want to record and the track becomes Recording Standby status. That track button will then become illuminated.

Make track and the input source settings

After selecting the track, use the input source buttons to select the input for that track. Using the INPUT button you can record in mono, stereo or a combination of both.

Selecting one track

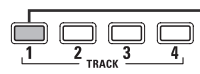

Same for tracks 2-4

Selecting two tracks

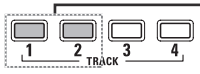

Same for tracks 3 and 4

For stereo input select MIC or 1 and 2

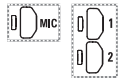

For mono input select either 1 or 2



These are the four possible input selections.

Note: These operations are not possible during recording and playback.

STEREO/4CH/STAMINA MODE



Move to the FOLDER SELECT menu



Move to the FILE menu



Move to the SPEED menu (only STEREO MODE)



Move to the REC FORMAT menu (STEREO MODE, 4CH MODE)

These operations are not available during recording and playback.

HINT:

When stereo link active

When tracks are stereo-linked, pressing the button for one track will have the same effect on the linked track.

4-4 Using INPUT MIC, 1 and 2 buttons

These buttons have different functions depending on the various modes.

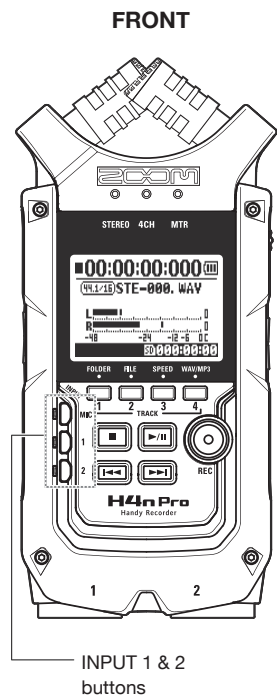

STEREO/STAMINA MODE

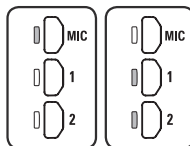

Select INPUT MIC, 1 or 2 and the corresponding button lights.

If you select INPUT 1 or 2, buttons will light after the selection. (Once lit, the buttons do not respond.) Any other input source settings, such as REC LEVEL, will be made for the lit source.

Note: If the selected input clips, its button will blink.

4CH MODE



Use all input sources. MIC, 1 and 2 all light.

When you switch to 4CH, the H4n Pro will receive two stereo inputs: one from MIC and one from 1 and 2 together. When you press a lit button, the channel input level is shown and you can adjust its recording level (REC LEVEL).

Note: When an input clips the corresponding button blinks.

MTR MODE



Set MIC, 1 and 2 individually for stereo and mono input. The corresponding button lights.

You can select INPUT MIC, 1 and 2 individually.

- When you use the built-in or an external stereo microphone, select INPUT MIC.
- For stereo input using the external input jacks, use both INPUT 1 or 2 button and then press another button.

Note: If the selected input clips, its button will blink.

HINT:

What is clipping?

If the input level reaches the maximum that the H4n Pro can record (0 dB), the recorded sound could be distorted. The recording level should be adjusted.

4-5 Using REC LEVEL and VOLUME buttons

These keys allow you to adjust the levels of recording input and output volume.
(All the modes are the same.)

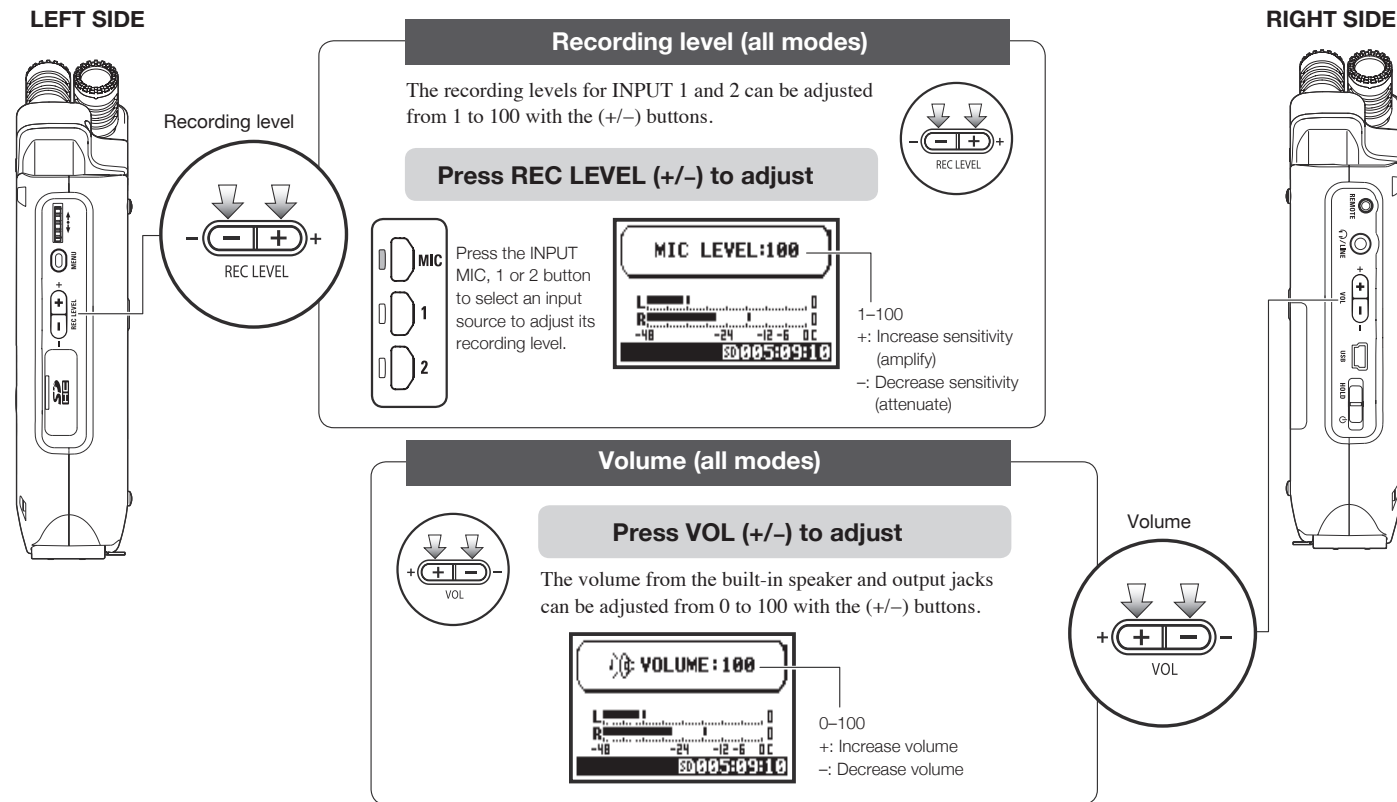

4-6 Using the DIAL and the MENU button

The DIAL and the MENU button are used for various settings while recording and during playback. Here are explanations about their basic operations.

RIGHT SIDE

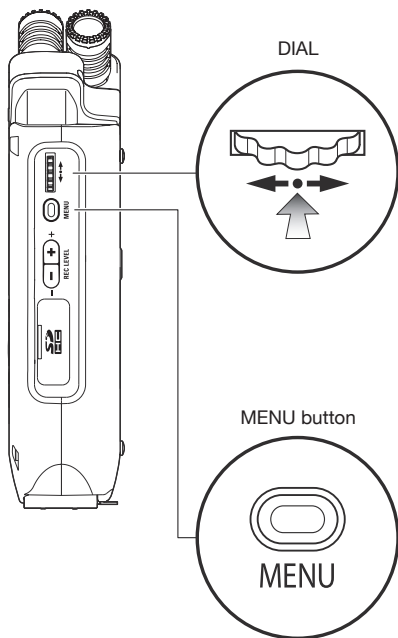

Basic DIAL operations



Rotate the DIAL to select an item

Rotate the DIAL, and the cursor on the display will move with the DIAL

Select



Press

Press the DIAL to confirm the selection

Press to DIAL and your selection will be confirmed.

→ When there are additional selections, press to move to the next screen.

→ When you complete selection, the screen returns to the previous one.

Basic MENU button operation

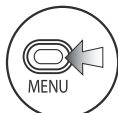

Opening the MENU screen

Press the MENU button to make settings for recording, playback and other functions.

Select



Long Press

Canceling a setting change

Press the MENU button during any setting operation, to cancel the operation and return to the previous screen.

To cancel a setting operation and return to the top screen of the mode, press the MENU button for more than 2 seconds.

Operation when the [] cursor appears (date and time setting, changing file names, etc)



Turn the DIAL to move the cursor.



Press the DIAL to change numbers and letters.

DIAL moves

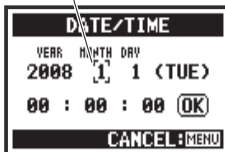
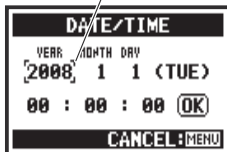

When the item is highlighted, rotate the DIAL to change the numbers and letters. Press the DIAL to confirm.

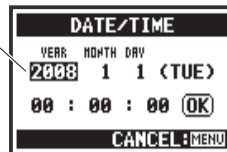

DIAL operation on the top screen

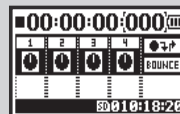

Turn the DIAL to move the cursor on the top screen. Press to enable counter adjustment or open the setting menu. (Only in MTR mode.)

Selecting items in lists



Turn the DIAL to scroll through a list.



Push the DIAL to confirm a selection.

DIAL moves

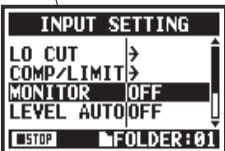
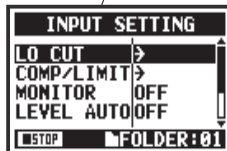

The screen returns to the previous one.

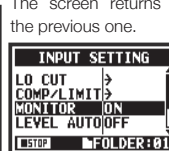
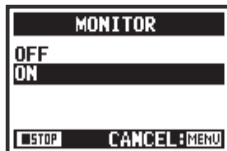

About the → in selection lists



When you see an →, there are more selections on the next screen.

Select the arrow and press the DIAL to move to the next screen.

5-1 Loading an SD card

The SD card is required to record. Make sure to turn off power before inserting or removing the SD card.

How to install an SD card

1 Make sure power is off.

2 Insert the SD card into the slot.

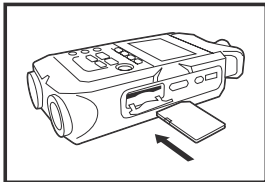

How to remove an SD card

1 Make sure power is off.

2 Push the SD card in to remove it from the slot.

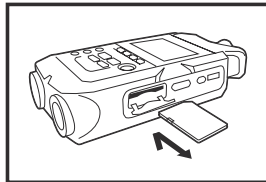

SD card recording capacity (approximate)

4GB SDHC card	Recording time (approximate)
44.1 kHz/16-bit WAV (stereo track)	380 minutes
44.1kHz/128kbps MP3 (stereo track)	68 hours

NOTE:

TURN THE POWER OFF!

Never insert or remove an SD card while the power is on. This could destroy data.

CAUTIONS WHEN INSERTING SD CARDS

- You can use 16MB to 32GB SD cards. For a list of operation-certified SD cards please refer to the ZOOM website: zoomcorp.com
- If you use an SD card that was used by a computer, digital camera or other machine, formatting in the H4n Pro is required.
- If “No Card” appears on the display at startup, check if the SD card is correctly inserted.
- When “Format Card” appears on the display at startup, this means the SD card has not been formatted in the H4n Pro. To format it, press the DIAL and select YES.
- When the startup screen says “Card Protect”, the card is write-protected. To disable this, slide the lock switch on the SD card.

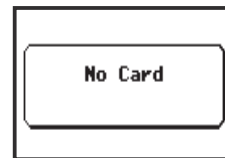

No SD card warning when starting up.

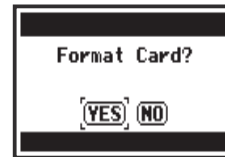

This warning will appear if an SD card is not in a recognized format. Select YES to format the card. This will delete all of its data.

5-2 Setting the date and time (DATE/TIME)

Each file will automatically record the date/time.

To facilitate searching for files by date, be sure to set the date/time after every battery change.

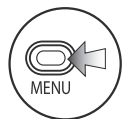

1 Press.



2 Select SYSTEM and press.

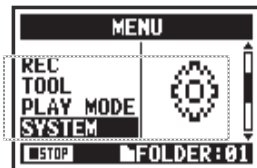

3 Select DATE/TIME and press.



5 Select OK and press.

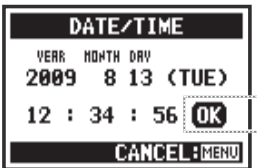

4 Set YEAR → MONTH → DAY → TIME (hour: minute: second)

Select the item on DATE/TIME:

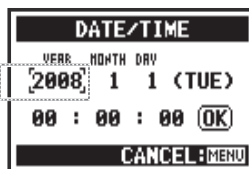

Turn the DIAL to select the item.

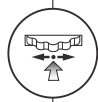

Press the DIAL.
The selected item value is highlighted.

Change the value.

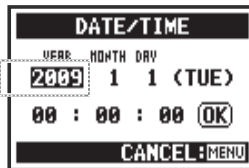

Turn the DIAL to set the value.



Press the DIAL.
The cursor appears again.

NOTE:

If “Reset DATE/TIME” appears during startup, the date/time needs to be set.

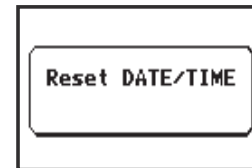

- If no power source is connected for more than three minutes, the DATE/TIME setting will reset to the default value.
- You cannot set this during recording and playback.

6-1 Setup: Connecting external devices

The H4n Pro offers versatile connectivity with options for any recording application.

Remote control
(optional)

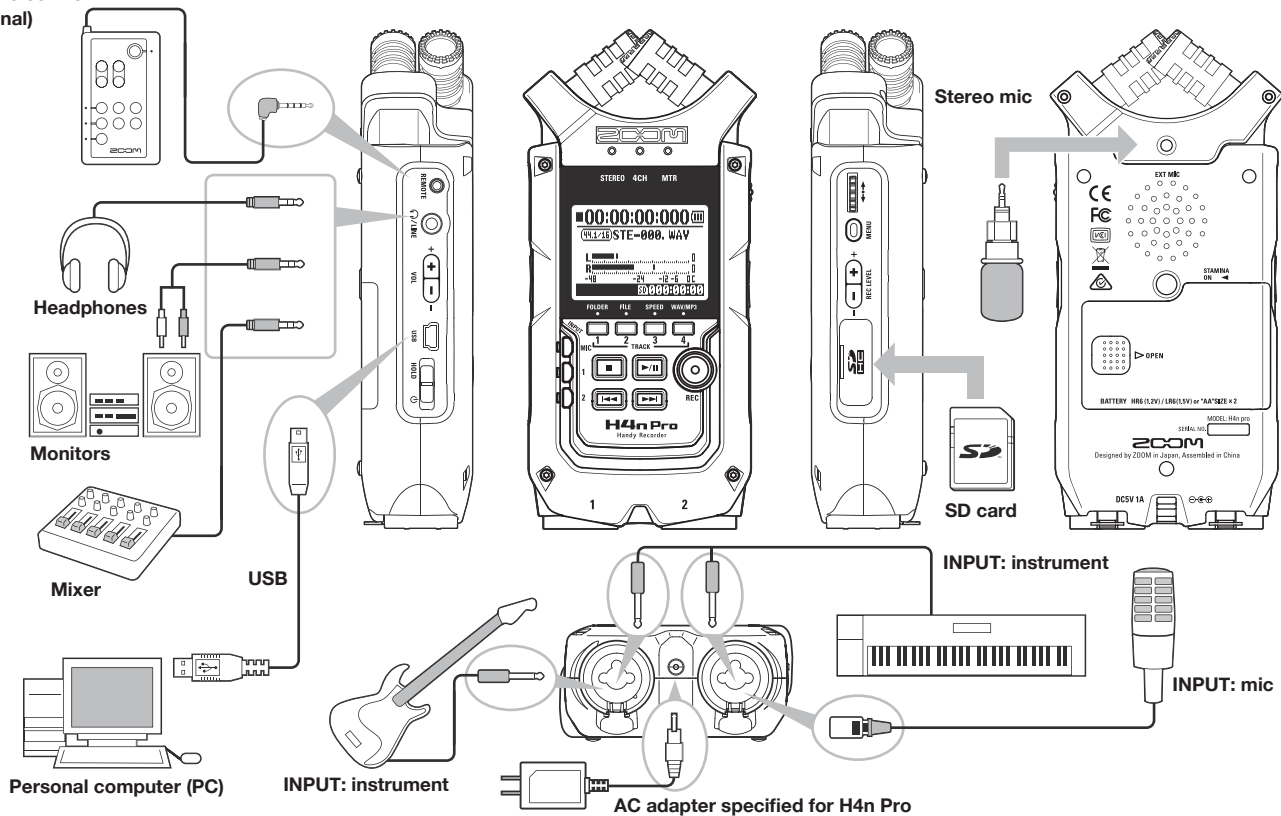

6-2 Setup: Built-in microphones

These are the special features of the H4n Pros built-in microphones.

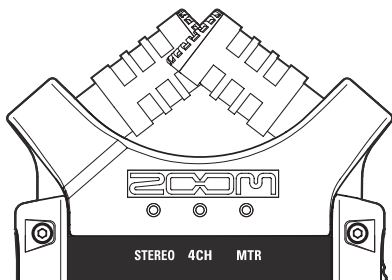

High quality microphones in an XY pattern ensure a natural stereo image when recording sounds.

Stereo recording is often done by placing two microphones in a V-shaped configuration. Pointing microphones outward will result in stereo separation, but the recording will lack definition around the center, resulting in a poor stereo image.

The H4n Pro utilizes an XY stereo mic configuration. By placing two microphones in a crossed pattern (opposite angles), the H4n Pro can cover a wide area and capture sound sources in the center with clarity and definition. Sounds reach both mics simultaneously, so no phase cancellation occurs between right and left channels.

XY mic placement

Capturing the stereo image center

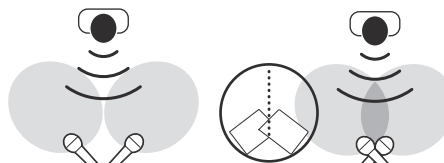

Ordinary stereo mic placement

H4n Pro stereo mic pair

Stereo images without phase cancellation.

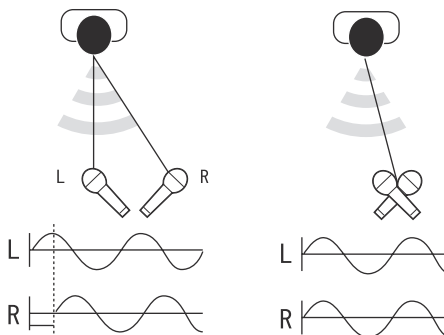

Ordinary stereo mic placement

H4n Pro stereo mic pair

90° or 120° directivity

Centered 90°

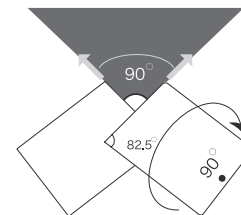

Movable

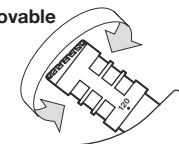

Wide 120°

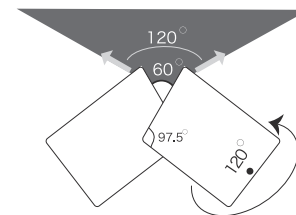

6-3 Setup: Built-in microphones/external mic with plug-in power

The input jack for the external microphone is suitable for microphones that require plug-in power.

Close microphone recording

Put the H4n Pro 30-50 cm from the sound source.

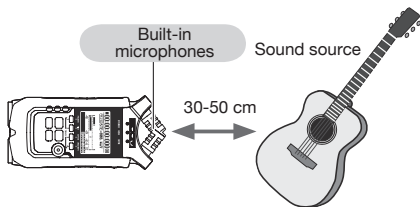

Off microphone recording

Make sure the recording sound sources are all located in zone covered by the built-in microphones.

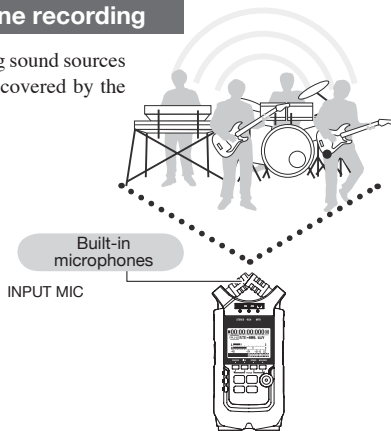

Close microphone recording

When you use an external microphone, be sure to select the correct setting.

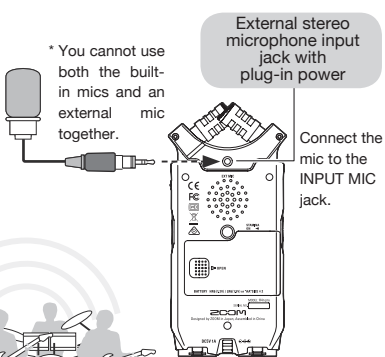

NOTE:

Plug-in and phantom power cannot be set during recording and playback.

Setting PLUG-IN power



Press the MENU button for more than 2 seconds, and start operation from the top screen.

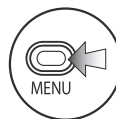

1
Press.



2
Select INPUT and press.

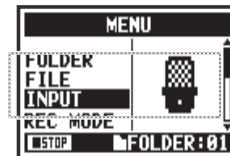

3
Select PLUG-IN and press.

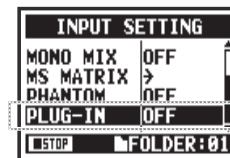

4
Select ON and press.

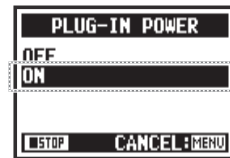

6-4 Setup: INPUT 1/2 connections and phantom power

Use INPUT 1 and 2 to connect to a guitar, bass or keyboard, for example.

Connecting instruments

You can directly plug a guitar or a bass into either INPUT 1 or INPUT 2.

Plug a keyboard with stereo output into both INPUT 1 and 2.

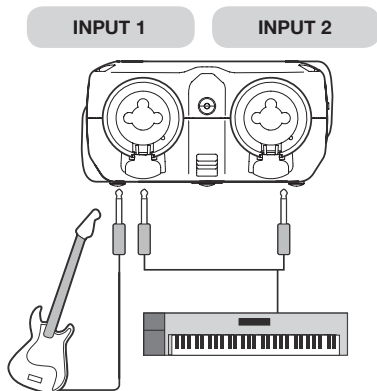

Connecting microphones

Connect microphones with XLR plugs to INPUT 1 and INPUT 2. If you need phantom power, such as when using a condenser microphone, make the following setting.

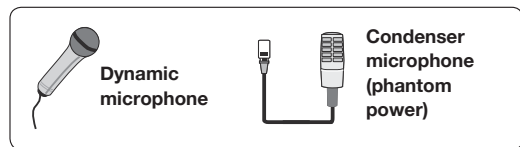

NOTE:

Some condenser microphones cannot operate with +24V phantom power, but compared to the +48V setting this reduces power consumption during battery operation.

Setting PHANTOM power



1
Press.



2
Select INPUT and press.

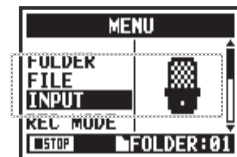

3
Select PHANTOM and press.



4
Select the voltage and press.

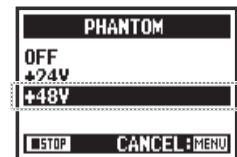

6-5 Using as a USB audio interface

The H4n Pro can be used as a two-in/two-out USB interface at 44.1 or 48 kHz.

Power ON already

Connect H4n Pro to computer with USB cable.

Power OFF

H4n Pro starts up using USB bus power, and USB setting screen opens

1 Connect H4n Pro to computer with USB cable.

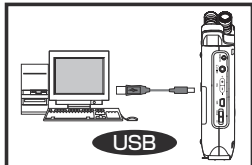

2 Press  when on the top screen.



3 Select USB and press.

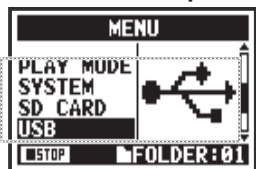

4 Select AUDIO I/F and press.

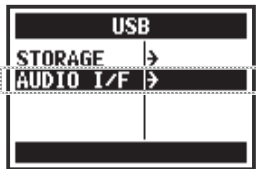

5 Select FREQUENCY and press.

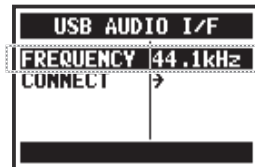

6 Select a sampling rate and press.

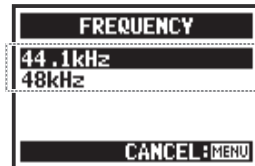

7 Select CONNECT and press.



Input or output levels

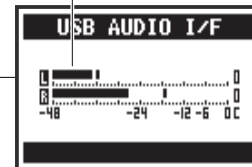

Two channels can be sent and received at 44.1 or 48 kHz while connected to a computer.

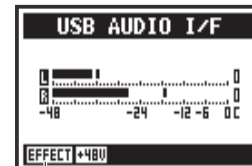

Active function

Ref. 	
EFFECT	P.083
TUNER	P.075
MONITOR	P.070
PHANTOM	P.030
PLUG-IN	P.029

Button operation in AUDIO I/F menu



Press.

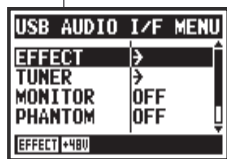

AUDIO I/F MENU

EFFECT	Use effects (only 44.1 kHz)
TUNER	Use tuner
MONITOR	Enable monitoring
PHANTOM	Enable phantom power
PLUG-IN	Enable plug-in power
DISCONNECT	End connection



Select and press.

Selection of input source

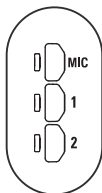

When you select an input the corresponding button lights, confirming the selection. To turn off the input, press the corresponding button so the light turns off.

To monitor input signals, you must turn MONITOR on.

Note: If no input is selected and no input buttons are lit, no signal is being sent to the computer.

These buttons are usable during setting

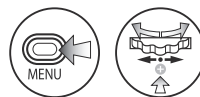

Open MENU and make settings

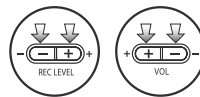

Adjust input and output levels

NOTE:

- You cannot change the sampling rate while the computer identifies the H4n Pro as an audio interface.
- When connecting as an interface, make sure the sampling rate (step 6) matches the recording software and playback file.
- You cannot change this setting during recording and playback.

HINT:

Audio interface use

- You can record and playback signals directly to and from your DAW software using the H4n Pro.
- In this mode, you can use the H4n Pros built-in effects on input signals if the sampling rate is set to 44.1kHz.
- No specific driver is needed to use the H4n Pro as a USB audio interface.
- When using a DAW or other software, refer to its manual.

6-6 Setup: Using as a USB SD card reader

When you use the H4n Pro as an SD card reader, make the following settings.

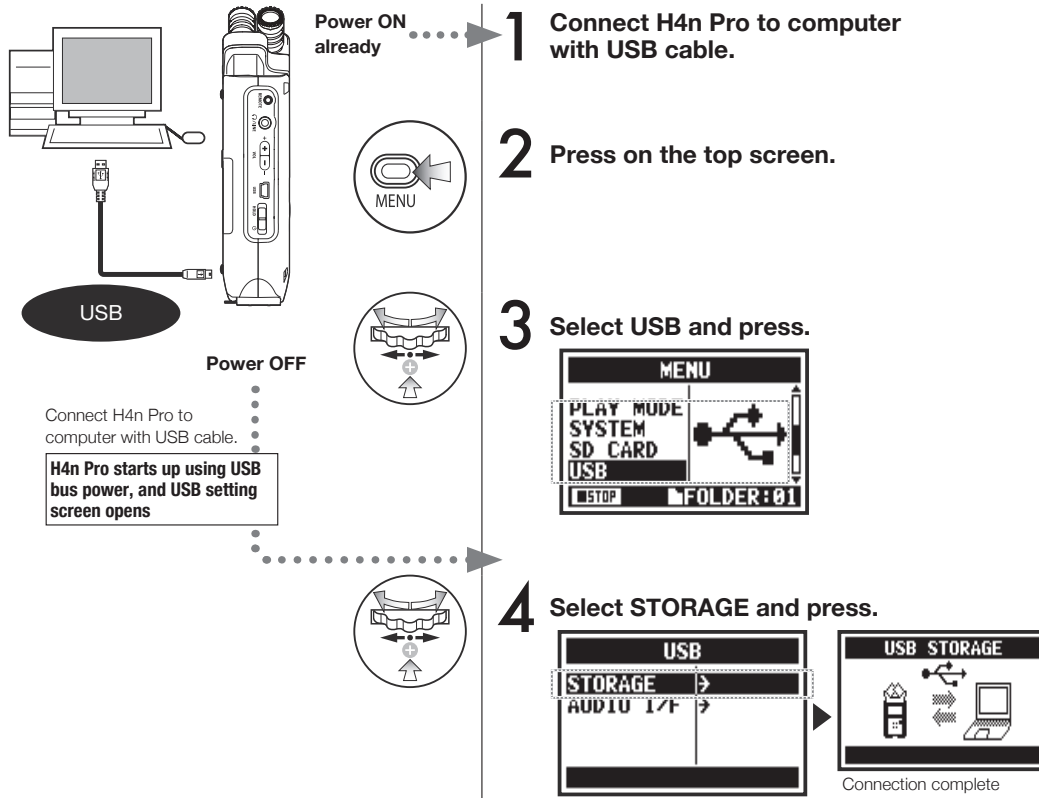

NOTE:

- Before physically unplugging the USB cable (and H4n Pro) from the computer, be sure to use the “Safely Remove Hardware” function on the computer first. Unplugging the USB cable (and H4n Pro) without doing this could damage files.
- Compatible operating systems: Windows Vista and newer
Mac OS X (10.6 and newer)

HINT:

USB bus power

USB bus power is a way to supply power from a computer through the USB cable.

Connecting the H4n Pro by USB when its power is off causes it to automatically start up and show the USB menu.

SD card reader use

- Use files recorded by the H4n Pro on your computer.
- Use audio files created on a computer on the H4n Pro.

6-7 Setup: Built-in speaker

The H4n Pro is equipped with a built-in mono speaker.

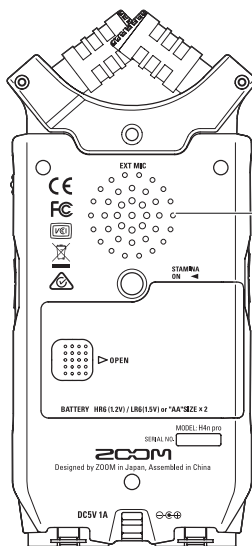

H4n Pro built-in speaker

This is a mono speaker for playback. Use it to easily play and listen to recorded data without connecting headphones to the LINE/PHONE jack.

NOTE:

Speaker output is disabled:

- When the LINE/PHONE jack is connected
- When MONITOR setting is ON
- When in recording standby in MTR mode

Speaker can be used:

- During file playback
- When used as an audio interface
- When nothing is connected to the LINE/PHONE jack

7-1 Mode overview

The H4n Pro has four operation modes: STEREO, STAMINA, 4CH (4-channel) and MTR (multitrack). Choose the mode according to your need.

• STEREO mode

You can easily create a stereo recording using the built-in microphones or an external microphone.

The STEREO mode is convenient for recording live band performances, acoustic instruments, voices, lectures, and subtle soundscapes. You can then use it to play stereo WAV and MP3 files.

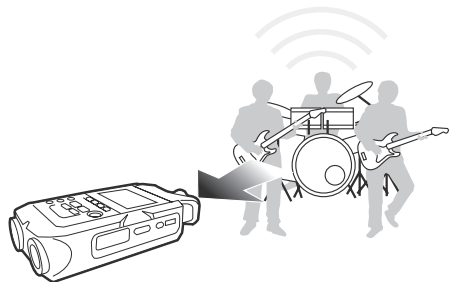

- One-pass stereo recording of live performances and rehearsals
- Direct recording of a single instrument
- Field recording
- Voice memos
- Recording meetings

• STAMINA mode

This mode enables longer battery life. STAMINA mode is similar to STEREO mode, but has less functions.

The continuous usage time with alkaline batteries is approximately 11 hours (but could be less depending on usage).

When in STAMINA mode, the H4n Pro can only record/playback in WAV 44.1kHz/16-bit and MP3 formats.

To enable STAMINA mode when using batteries, set the STAMINA switch before turning the power on.

►P015

- Field recording
- Live outdoor recording
- At conferences and in other situations when changing batteries is difficult

• 4CH mode

In 4CH mode, you can record two stereo signals simultaneously. You can capture live sounds via the built-in mics and direct instruments via external inputs at the same time.

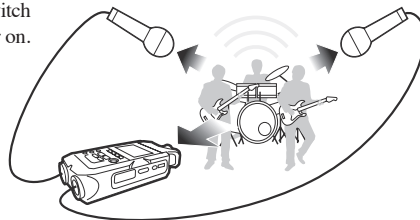

- Simultaneous recording with both line input and mics
- Surround recording via front and rear microphone placement
- Simultaneous recording of both ambient and direct sound sources
- Recording both ambient and direct sounds to add a live feel to recorded performances

• MTR mode

You can record using effects in this mode. You can also overdub recordings and use sound files previously recorded using the other modes.

When creating a demo, you can record backing tracks at home and record instrumental tracks in the studio while listening to the backing tracks.

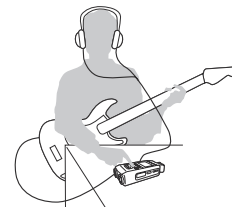

- Recording parts one track at a time
- Overdubbing
- Recording using effects
- Mixing track levels after recording
- Indoor and outdoor rehearsals

7-2 Switching and confirming modes

Be sure to select the appropriate mode for your application.

STEREO **4CH** **MTR** Press the MENU button for more than 2 seconds, and start operation from the top screen.

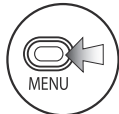

1 Press.



2 Select MODE and press.

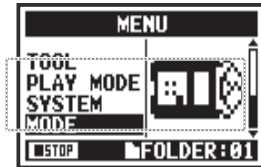

3 Select among STEREO, 4CH and MTR modes and press.

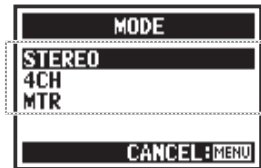

Note: To engage STAMINA mode, use the switch located in the battery compartment.

HINT:

Mode confirmation

- The current mode is indicated by a mode indicator LED on the front panel.
- The H4n Pro will power up in the same mode it was in when turned off.
- When starting up for the first time, the default mode is STEREO.

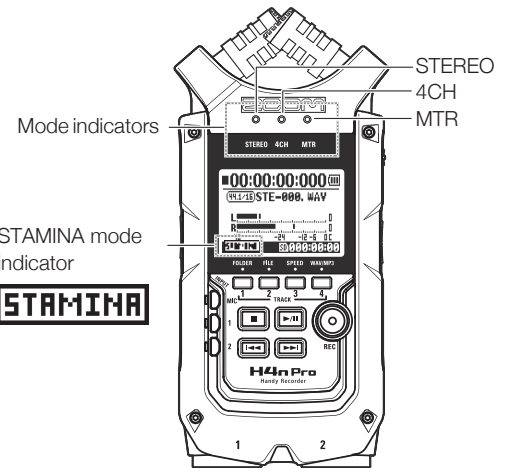

7-3 Mode details

Input and output levels as well as saving and file formats are different in each mode.

STEREO mode

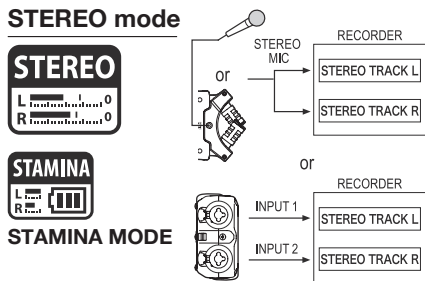

In STEREO mode, you can select 2 different inputs either INPUT MIC or INPUT 1 and 2, and record and play one stereo file at a time.

Files are saved in one of the ten sub-folders in the STEREO folder.

In STAMINA mode, the functions are limited to maximize the battery life time.

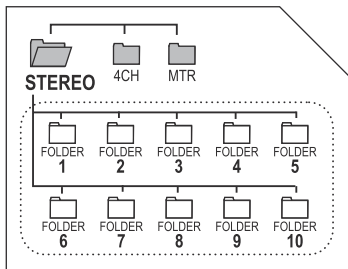

4CH mode

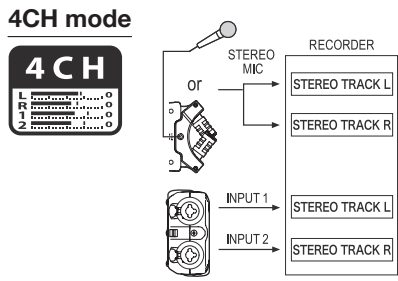

In 4CH MODE, the H4n Pro records two stereo WAV files: one stereo WAV file for the built-in mic or stereo mic input and one stereo WAV file for INPUT 1 and 2.

These FILES are saved in one of the ten 4CH sub-folders.

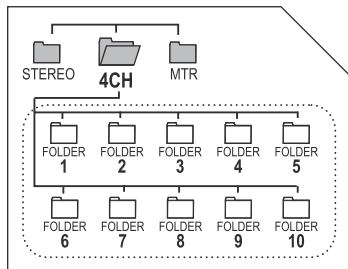

MTR mode

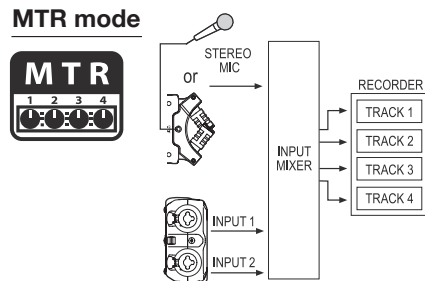

You can record tracks in MONO or STEREO from INPUT 1, INPUT 2 and a stereo microphone.

You can combine them with tracks recorded in other modes and overdub existing tracks.

In MTR mode, project data and settings are saved as a project in the MTR folder.

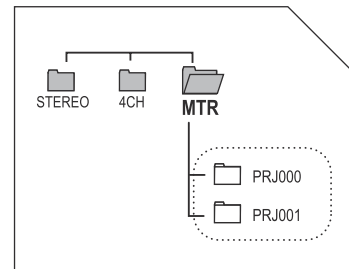

8-1 Mode screens: STEREO and STAMINA modes



• Explanation of the top screen

Recorder status

- Stopped
- || Recording standby
- ▶ Playing
- Recording
- || Paused

Blinks

REC button blinks

REC button lights

Counter

Elapsed recording or playback time
(hours): (minutes): (seconds): (milliseconds)

Remaining battery life (when battery used)

If "Low Battery" appears on the display, it is time to change the batteries.

File format

Format of file selected, being recorded or playing back

- WAV file: kHz/bit
- MP3 file: bit rate

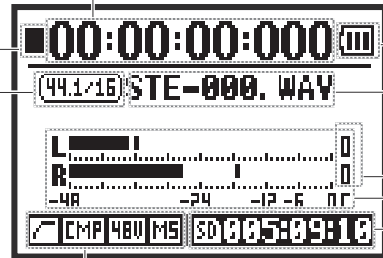

File names

Name of file selected, being recorded or playing back

If there is no file in any folder, "No Data" appears.

96/24 96kHz/24-bit WAV indicator

128kbps 128kbps MP3 indicator

Clipping indicators

The clip indicators "light" if the recording or playback level reaches 0 dB and remain lit until the file ends or the stop button is pressed.

STAMINA MODE

Stamina icon

- Optional setting indicators**
- These icons appear on the display when optional functions are ON.
- LO CUT function P.066
 - COMP COMP/LIMIT function P.067
 - 48V Phantom power (48V/24V) P.030
 - MS MS stereo matrix P.073

Level meters

Recording and playback levels

Remaining recording time

Remaining possible recording time on SD card

8-2 Mode screens: 4CH mode



• Explanation of the top screen

Recorder status

Stopped
 Recording standby ● Recording
 Blinks REC button blinks REC button lights
 Paused
 Blinks

File format

Format of file selected, being recorded or playing back

Optional setting indicators

These icons appear on the display when optional functions are ON.

- LO CUT function P.066
- COMP/LIMIT function P.067
- Phantom power (48V/24V) P.030
- MS stereo matrix P.073

Counter

Elapsed recording or playback time (hours): (minutes): (seconds): (milliseconds)

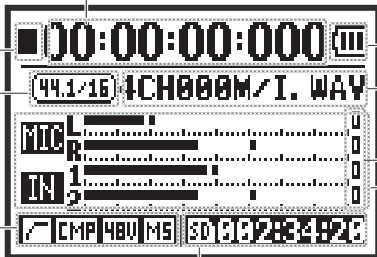

Remaining recording time

Remaining possible recording time on SD card

Remaining battery life (when battery used)



If "Low Battery" appears on the display, it is time to change the batteries.

File names

Name of file selected, being recorded or playing back

If there is no file in any folder, "No Data" appears.

Clipping indicators

The clip indicators "light" if the recording or playback level reaches 0 dB and remain lit until the file ends or the stop button is pressed.

Input sources and level meters

Input sources and recording and playback levels

MIC Input from either the built-in mics or an external stereo mic

IN Input from INPUT 1 and INPUT 2

8-3 Mode screens: MTR mode



• Explanation of the top screen

DIAL operations on top screen



Recorder status

Stopped

Recording

Recording Standby

Paused

Playing

1 Counter

Elapsed recording or playback time
(hours): (minutes): (seconds): (milliseconds)

Counter function:
Specify a time Ref. P.102

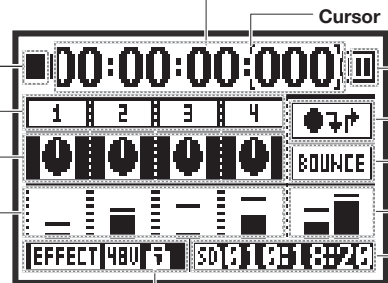

Remaining battery life (when battery used)



If "Low Battery" appears on the display, it is time to change the batteries.

Optional setting indicators

These icons appear on the display when optional functions are ON.

3 Auto punch in/out icon

Selecting this icon brings up the PUNCH IN/OUT settings.

The icon only appears when recording in OVERWRITE mode. P.056

2 Track menu icons

Select an icon to access the track menu where settings, including volume, panning and stereo/mono, can be made.

P.057

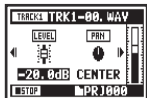

4 BOUNCE ICON

Selecting this icon brings up BOUNCE settings. P.123

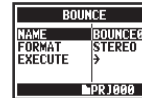

Level meters

These show the recording or playback levels of tracks 1-4.

Remaining recording time

Remaining possible recording time on SD card.

L/R level meters

These show the master left and right output levels.

8-4 Mode screens: MAIN MENU

This is a list of the menu items that appear for each mode when the MENU button is pressed.

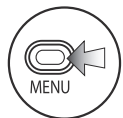
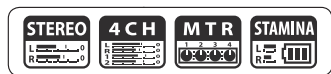

1 Press.



2 Select item and press.

Cancelling:
To return to the top, press the MENU button more than 2 seconds.



STEREO mode

FOLDER



FILE



INPUT



REC



TOOL



STAMINA mode



4CH mode

FOLDER



FILE



INPUT



REC



TOOL



MTR mode

PROJECT



FILE



EFFECT



INPUT



REC MODE



HINT:

The ▼ icon marks the item first shown in the MENU after the unit is started or the mode is switched. After the menu has been opened previously, the last used item will be shown first.

Information at MENU screen bottom

On menu pages where recording and playback are possible, the current status is shown at the bottom left of the screen.

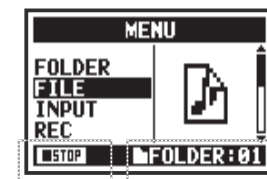

The current folder number is shown at the bottom right of the screen, (in Stereo, 4CH and Stamina modes).



In MTR mode, the current project name is shown.

	Stopped
	Paused (playback)
	Playing back
	Recording standby/ paused
	Recording standby In MTR mode and OVER WRITE recording
	Recording

PLAY MODE SYSTEM SD CARD USB MODE



▶ ⚙ Enable STAMINA mode with the STAMINA switch before starting the unit when running on batteries. **P.015**

MIXER PLAY MODE SYSTEM SD CARD USB MODE



TOOL SYSTEM SD CARD USB MODE



9 Optional remote control operation

You can operate the H4n Pro from a distance with the optional remote control.

Remote control button operation

VOLUME +/-



0-100
 +: increase (raise)
 -: decrease (lower)

INPUT MIC, 1 and 2 buttons and indicators (green, yellow, red)

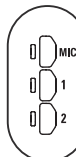

Select the input source
 The indicator corresponding to the button shows the input status.
 Green: selected input source
 Yellow: input level is over -6 dB
 Red: input is clipping

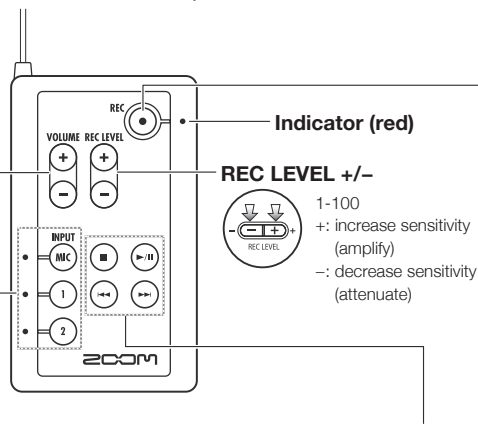

REC button

Recording and placing marks.

STEREO	Stopped	Enter recording standby and reset counter to 0.	
4 CH	Recording standby	Start recording and counter.	
STAMINA	Recording	Playing	Add mark (WAV files only)

This can be used only when a track is in recording standby.

MTR	OVER WRITE recording
Stopped	Enter recording standby
Recording/standby	Stop recording (playback continues)
Playing	Recording starts and counter continues
ALWAYS NEW recording	
Stopped	Stop recording and counter
Recording standby	Start recording and start counter

Transport buttons

FF and REW buttons

STEREO	Stopped	Press for less than one second FF: Show next file REW: Return to file beginning (If there are marks, FF and REW jump to the nearest mark)
4 CH	Playing	
STAMINA	Playback paused	

Press for more than one second
 Search forward/backward
 The longer the button is pressed, the faster the search speed. Searching will stop at the beginning or end of the file.

MTR	Stopped	Press for less than one second FF: Skip forward one second REW: Return to beginning
	Playing	
	Playback paused	Press for more than one second Search forward/backward

STOP button

STEREO	Recording/recording standby/paused	Stop recording and reset counter to 0
4 CH	Playing/paused	Stop playback and stop counter
STAMINA		

MTR	Recording	Stop recording and stop counter
	Playing	Stop playback and stop counter
	Recording paused	
	Playback paused	Stop recording/playback

PLAY/PAUSE button

STEREO	Stopped	Start playback and start counter
4 CH	Recording standby	Start recording and counter
STAMINA	Recording/paused	Resume paused recording
	Playing/paused	Resume paused playback

MTR	Stopped	Start playback
	Recording	While overwrite setting: Stops recording While always new setting: Pauses recording
	Recording standby	Start recording and the counter begins to move
	Playing	Pause playback

Operations

1-01 Settings/recording: Setting input sources and recording levels

Make recording settings for the built-in mics and external input jacks.

STEREO MODE

Use either MIC or INPUT 1 and 2 as the stereo input source.

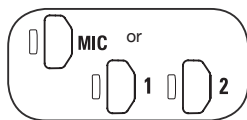
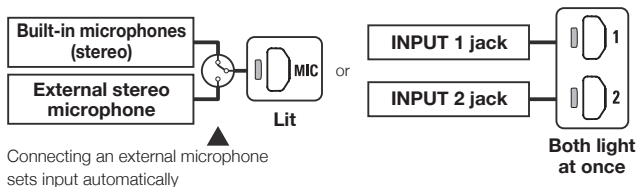

1 Select INPUT and press.

* Selection is possible when stopped, recording or in recording standby.

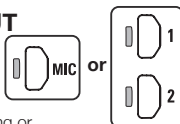

Selected buttons light

2 Use REC LEVEL to adjust the levels.

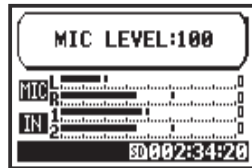
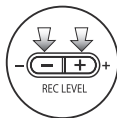

HINT:

INPUT 1 and 2 recording levels can be set independently.

Ref. Recording functions:
INPUT 1/2 LEVEL LINK **P.071**

4CH MODE

Use both MIC and INPUT 1 and 2 as stereo inputs.

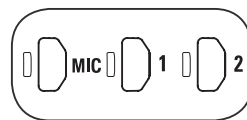
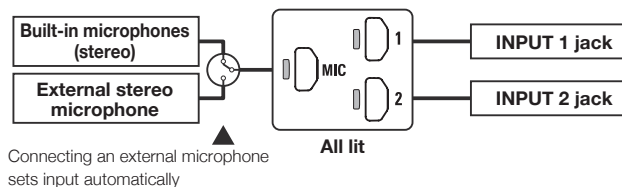

1 Select INPUT and press.

The recording level of the selected is shown

2 Use REC LEVEL to adjust the levels.

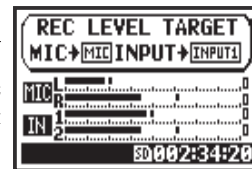
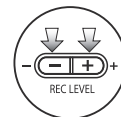

HINT:

On the 4CH mode top screen, if you press a REC LEVEL button, "REC LEVEL TARGET" appears. Select the input and adjust it.

MTR MODE

All tracks can be independently set for mono or stereo input.

Select input for each individual track and adjust.

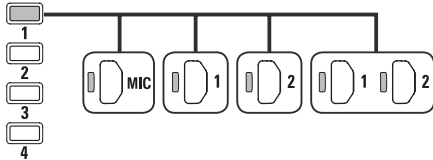

Select input for two tracks and adjust.

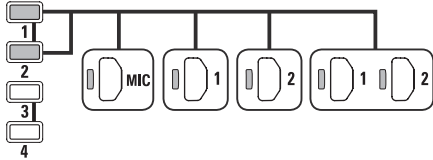

TRACK 1	TRACK 2	TRACK 3	TRACK 4
Mono	Stereo	Mono	Mono
Stereo		Mono	Mono
Mono	Mono	Stereo	
Stereo		Stereo	

Set the REC LEVEL

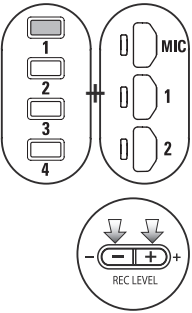

- 1 Press the selected track and input button.
- 2 Use REC LEVEL to adjust the level.

HINT:
In MTR mode, you can record multiple tracks separately. You can also select any input for each track when recording.

1-02 Settings/recording: Recording in STEREO and STAMINA modes

These are the steps to record in STEREO or STAMINA mode.

Recording process

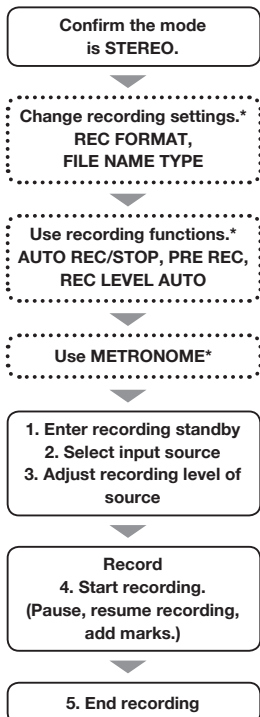

*You can record without making these settings.

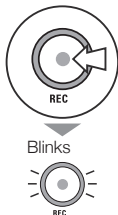
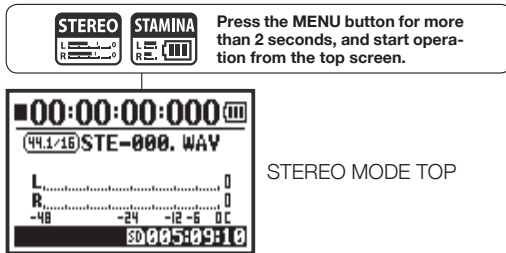

1 Press to enter recording standby.

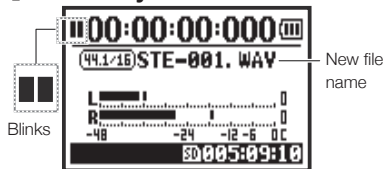

2 Select input source and press.

Press MIC to use the built-in mics, or press INPUT 1 or 2 to use external inputs.

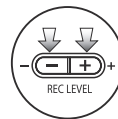
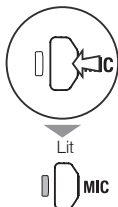

3 Adjust the recording level of the input source.

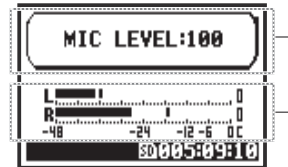

4 Press to start recording.



5 Press to end recording.

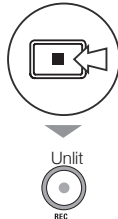
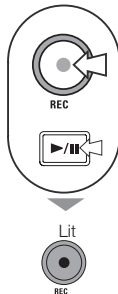
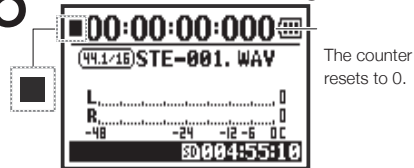

Pausing



Counter does not return to 0.

RECORDING AGAIN



HINT:

Recording format

In STEREO mode you can record in 19 different WAV and MP3 file formats. The recording format must be selected before recording a file begins.

File naming

Recorded files are named automatically. Choose from two formats. The default format is DEFAULT.

DEFAULT: STE-xxx

DATE: 090531-xxx

The recording date is in yymmdd format.

Marks

When the recording format is WAV, you can mark a file by pressing the REC button while recording. You can move swiftly to marked positions during playback.

When you pause recording of a WAV file, a mark will be added at the paused point.

NOTE:

During recording and playback, the recording format and file name type cannot be changed.

Ref.

REC FORMAT	P.049	FILE NAME	P.050
Mark setting	P.096	METRONOME	P.079
AUTO REC	P.063	PRE REC	P.065
REC LEVEL AUTO	P.069		

1-03 Settings/recording: Recording format (REC FORMAT)



Set the recording format (REC FORMAT) before recording.

Operations / Settings/recording: Recording format (REC FORMAT)

STEREO **4CH** Press the MENU button for more than 2 seconds, and start operation from the top screen.

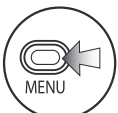

1 Press.



2 Select REC and press.

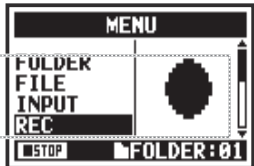

3 Select REC FORMAT and press.

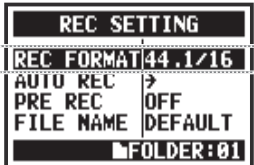

Shortcut
Press TRACK 4 on the top screen.



4 Select one and press.



Default:
WAV44.1 kHz/16bit

NOTE:

How to use WAV and MP3 format

- WAV files with no compression are used for high-quality sound recording. Since data is not compressed, files are larger than MP3 files.
- MP3 files have lower sound quality because of data compression, but are useful to save SD card capacity and record more.

HINT:

Types of WAV files

44.1/48/96 kHz indicates the sampling rate of the analog-to-digital conversion. 16/24-bit indicates the bit depth of the analog-to-digital conversion. The larger the number, the higher the sound quality, and the larger the file size.

WAV files recorded in STEREO/4CH/STAMINA mode comply with BWF (Broadcast Wave Format) and include marks and creation dates.

Types of MP3 files

Select the bit rate, which is the amount of data per second. The higher the number, the lower the rate of compression and the better the sound quality. MP3 files that are more compressed occupy less space on SD cards.

VBR (Variable Bit Rate) means the bit rate is automatically adjusted based on the input information.

REC FORMAT	
STEREO mode	
WAV	44.1kHz/16bit
	44.1kHz/24bit
	48kHz/16bit
	48kHz/24bit
	96kHz/16bit
MP3	96kHz/24bit
	48kbps
	56kbps
	64kbps
	80kbps
	96kbps
	112kbps
	128kbps
	160kbps
	192kbps
224kbps	
256kbps	
320kbps	
VBR	
4CH mode	
WAV	44.1kHz/16bit
	44.1kHz/24bit
	48kHz/24bit

1-04 Settings/recording: File name (FILE NAME)



When recording, the file name is automatically assigned. Follow these procedures to change the format.

STEREO **STAMINA** Press the MENU button for more than 2 seconds, and start operation from the top screen.

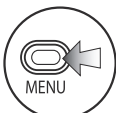

1 Press.



2 Select REC and press.

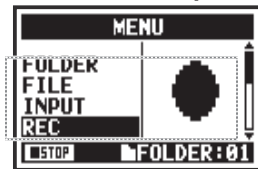

3 Select FILE NAME and press.

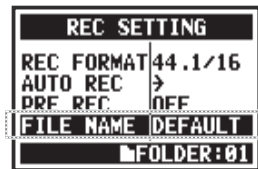

4 Select and press.

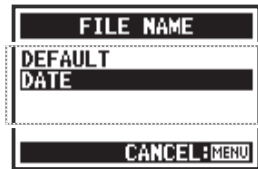

The default setting is DEFAULT.

File Name	
STEREO mode	
DEFAULT	STE/MONO--xxx.wav/mp3 (STE: stereo, MONO: mono; XXX: 3-digit number; wav/mp3 extension)
DATE	090531-xxx.wav/mp3 (yyymmdd; 3-digit number; wav/mp3 extension)
4CH mode	
No change	4CH-xxxM.wav File recorded using the built-in microphones 4CH-xxxI.wav File recorded using the external input
MTR mode	
Stereo and mono files	TRK1-xx.wav (TRK: track number; 2-digit number, extension) For stereo tracks, track numbers like 12 for L and R are used.

NOTE:

- You can set the DATE type only in STEREO mode.
- You can use other file names in STEREO and MTR mode. Use FILE RENAME to make these settings.

Ref. FILE RENAME P.109

1-05 Settings/recording: 4CH mode recording

This is the method to record 4 channels (2 stereo) from the built-in mic and the external input jacks.

Recording process

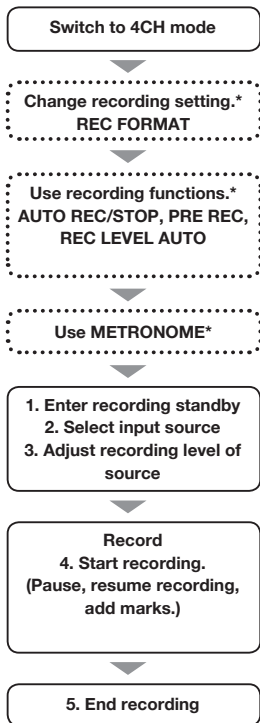

*You can record without making these settings.

4 CH Press the MENU button for more than 2 seconds, and start operation from the top screen.

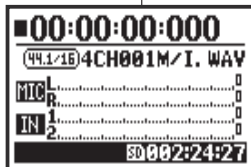

STEREO
MODE TOP

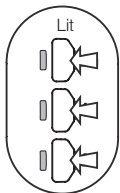

1 Press to enter recording standby.



New file name

2 Select the input sources and press.

Select mic for the built-in microphones
Select INPUT 1 or 2 for external inputs

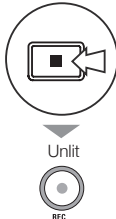
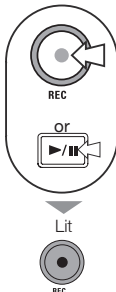
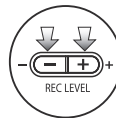

3 Adjust the recording level of the input source.

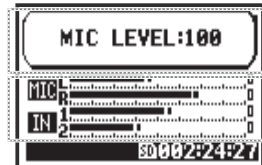

4 Press to start recording.

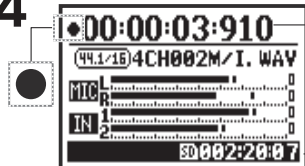

The counter and remaining time start changing.

5 Press to end recording.

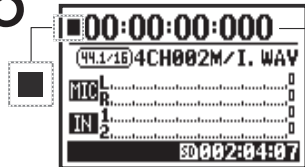

The counter resets to 0.

Pausing

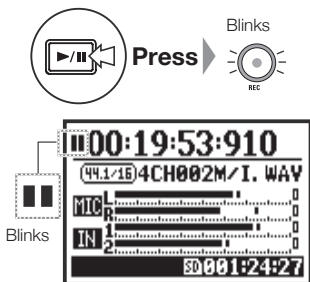

Counter does not return to 0.

RECORDING AGAIN

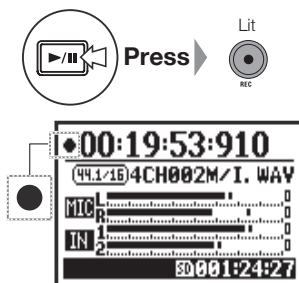

Continue recording from the paused position in the same file.

HINT:

File naming

In 4CH mode the input from the built-in and the external inputs are saved separately as stereo WAV files.

Those 2 files are always managed as a pair and named as follows according to the input.

MIC file: 4CHxxxM.wav

INPUT 1/2 file: 4CHxxxI.wav

On screen, the 2 files are shown together as M/I.

* You cannot change the file names.

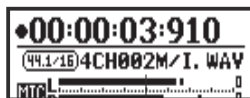

File name

Recording format

Change before recording.

Marks

When the recording format is WAV, you can mark a file by pressing the REC button while recording. You can move swiftly to marked positions during playback. When you pause recording of a WAV file, a mark will be added at the paused point.

NOTE:

During recording and playback, the recording format and file name type cannot be changed.

Ref.

REC FORMAT	P.049	FILE NAME	P.050
Mark setting	P.096	METRONOME	P.079
AUTO REC	P.063	PRE REC	P.065
REC LEVEL AUTO	P.069	Mode change	P.036

1-06-1 Settings/recording: MTR mode recording (REC MODE)

Using multiple tracks, you can combine mono and stereo recordings.

Recording flow

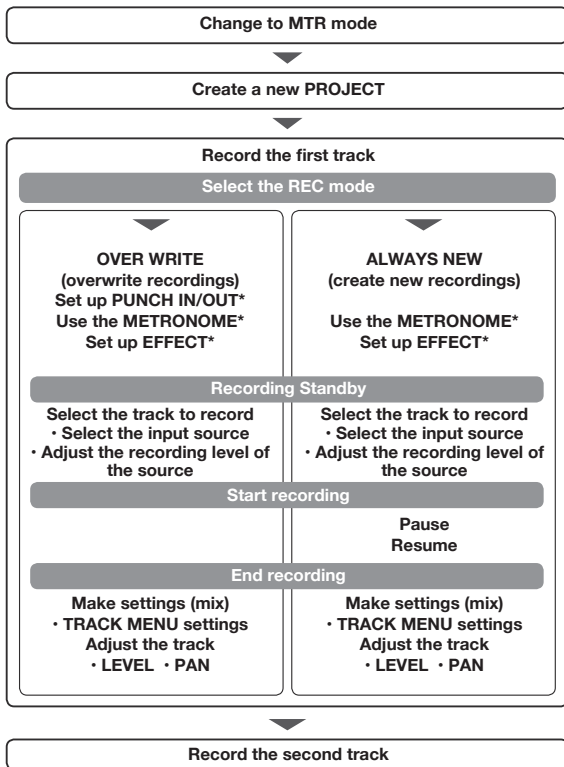

*You can record without making these settings.

Set REC MODE to OVER WRITE or ALWAYS NEW



Press the MENU button for more than 2 seconds, and start operation from the top screen.

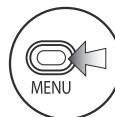

1 Press.



2 Select REC MODE and press.

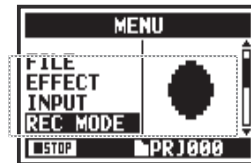

3 Select either OVER WRITE or ALWAYS NEW and press.



Input sources and tracks

When recording only one track

1. Input source is either INPUT 1 or INPUT 2



2. Input source is MIC or INPUT 1 and 2

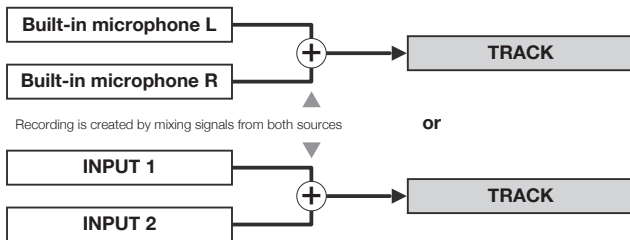

When recording two tracks

1. Input source is either INPUT 1 or INPUT 2

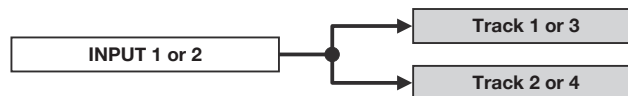

The same signal is sent to both tracks.

2. Input source is MIC or INPUT 1 and 2

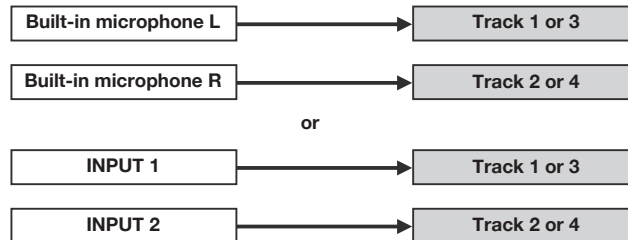

1-06-2 Settings/recording: MTR mode recording (OVER WRITE)



You can select from two recording modes.

Using the OVER WRITE mode, you can overwrite new sounds on the existing file.



Press the MENU button for more than 2 seconds, and start operation from the top screen.

Make settings as needed

Input setting ... P.054

Recording functions ... P.057-



1 Select the TRACK.

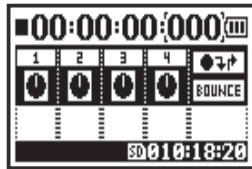

MTR mode top

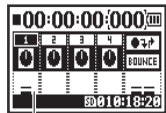

Shows input level

2 Press.

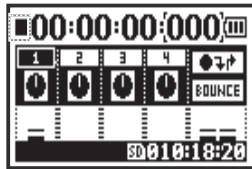

Counter will not reset to 0.



The selected TRACK lights

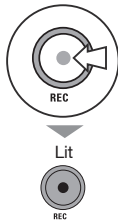

Lit

REC

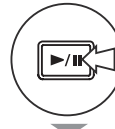

Lit



REC

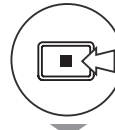

Unlit



REC

3 Press to start recording.

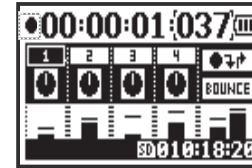

4 Press to stop recording.

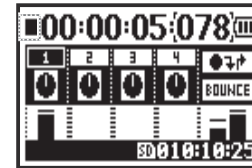

Counter does not reset to 0.

Use the REW button to return to the beginning of the file. Then, press the PLAY/ PAUSE button to listen to what you have just recorded.

1-06-3 Settings/recording: MTR mode recording (ALWAYS NEW)

In ALWAYS NEW mode, a new file is made for every recording.

 Press the MENU button for more than 2 seconds, and start operation from the top screen.

Make settings as needed  Input setting ... P.054
 Recording functions ... P.057-

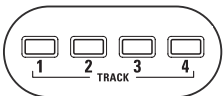

 1
The selected TRACK lights

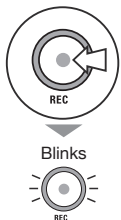

1 Select the TRACK.

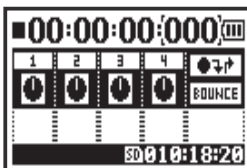

MTR mode top

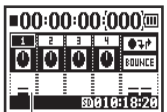
Shows input level

2 Press.

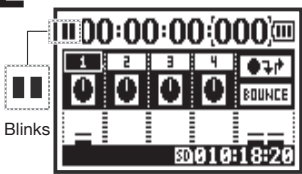

Blinks
Counter will not reset to 0.

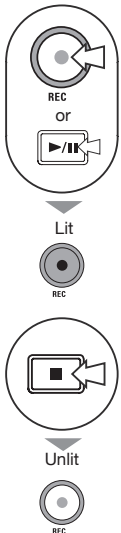

3 Press to start recording.

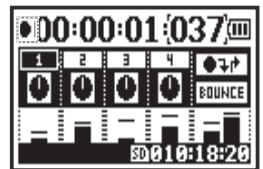

4 Press to stop recording.

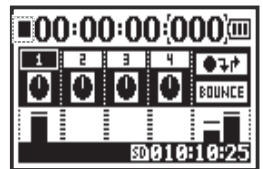

Counter does not reset to 0.

Use the PLAY/PAUSE button to listen to the recorded file.

1-07 Settings/recording: TRACK MENU

This menu to set tracks is available only in MTR mode.
Link tracks to create stereo track and set output effects.



Press the MENU button for more than 2 seconds, and start operation from the top screen.

Select a project and startP.119

Select TRACK MENU



1 On the top screen select a track menu icon and press.

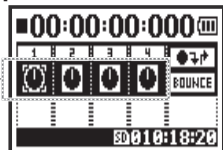

Track menu icon

TRACK MENU

Name of file assigned to track



Currently selected track

HINT: LEVEL

Set the track output level
Setting values: Mute, -48.0dB - +12.0dB
Default: 0.0dB

Adjust the track output level



Select LEVEL and press.



Set the value and press.

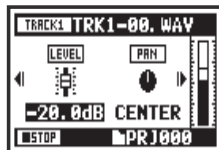

Fader icon changes

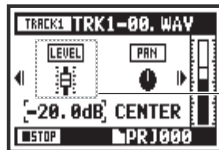

HINT: PAN

Set the left-right position of the track.
Setting values: L100 - C - R100
Default: C (Center)

Adjust the panning



Select PAN and press.



Set the value and press.



Pan icon changes





NOTE:

STEREO LINK, FILE and KARAOKE settings are not available during recording or playback for tracks that are record ready.

HINT: Stereo link

Turning stereo link ON creates a stereo track from tracks 1 and 2 or 3 and 4. Setting stereo link OFF creates mono tracks. Setting values: ON/OFF (default: OFF)

NOTE:

- You can only play mono files on mono tracks and stereo files on stereo tracks.
- When LINK is turned ON, no file will be assigned to the track, so "NO DATA" will appear.
- If you change it from ON to OFF, the previous PAN setting is restored.
- When you change from OFF to ON, the LEVEL and PAN settings are reset to their defaults.

NOTE:

- You cannot record on the KARAOKE track.
- If LINK is turned ON automatically when set to a mono track, "NO DATA" will result.
- When a KARAOKE track has been set, you cannot set other tracks to KARAOKE.

HINT: Karaoke

You can only use the KARAOKE setting on one pair of stereo tracks: either 1 and 2 or 3 and 4. In KARAOKE mode, you can use KEY CONTROL and CENTER CANCEL functions. Setting values: ON/OFF (default: OFF)

Setting stereo link



Select LINK and press.

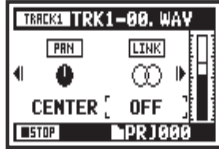

Set the value and press.

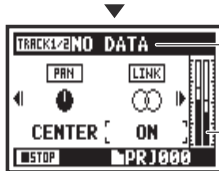

Since format changed, "NO DATA" appears.
Level meter becomes stereo.

Assigning files to tracks



Select FILE and press.

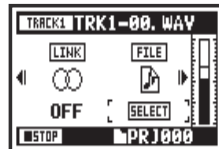

Select the file to be assigned and press.

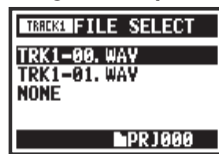

List of files with the matching format that can be assigned

Setting KARAOKE



Select KARAOKE and press.



Set the value and press.

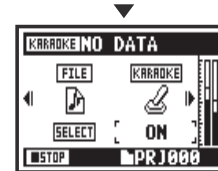
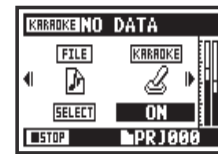

1-08-1 Settings/recording: Automatic re-recording (PUNCH IN/OUT)

The PUNCH IN/OUT function allows you to partially re-record a recorded file.
Here we explain how to use PUNCH IN and PUNCH OUT automatically.



Press the MENU button for more than 2 seconds, and start operation from the top screen.

Change the REC MODE to OVER WRITEP.053

Assign files to tracks

Set the recording start (punch in) point



1 On the top screen select the track menu icon and press.

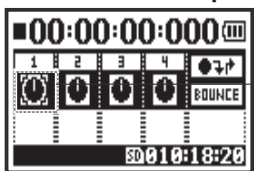

Track menu icon



2 Select FILE and press.

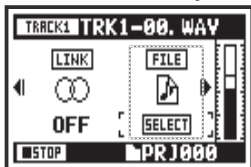

3 Select the desired file and press.

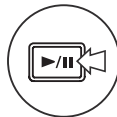

4 Press to start playback.

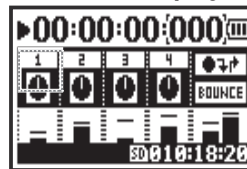

5 Select the punch in/out icon and press.

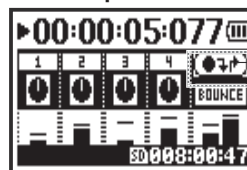

Punch in/out icon



6 Find the desired punch in point and press.

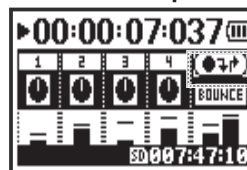

Icon changes

NOTE:

Setting available only for OVER WRITE recording in MTR mode.

Set the recording end (punch out) point



7 Press the desired punch out point.

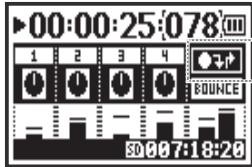

PUNCH OUT setting confirmed

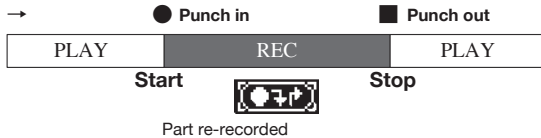

HINT:

- You can set the punch in/out points while stopped by using the counter. First set a time and move the cursor to the punch in/out icon, and then press the DIAL.
- After setting the punch out point in step 7, pressing the DIAL again will cancel all the settings.

Re-recording

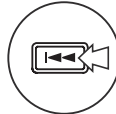

8 Rewind to the file beginning (counter at 0) or to a position before the punch in point.

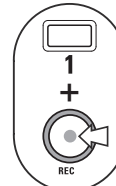

9 Press to put TRACK 1 into recording standby.

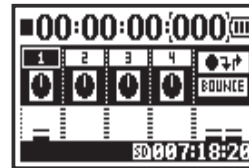

1 When in punch in/out mode, the track button lights during recording and blinks in recording standby.

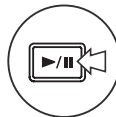

10 Press to start TRACK 1 playback/recording.

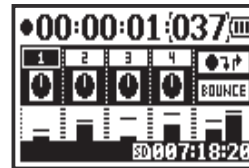

When the track reaches the punch in point, the REC light will turn on and recording will start.



When the track reaches the punch out point, the light will blink and recording will stop.

Ref. Specifying a counter time **P.102**

1-08-2 Settings/recording: Manual re-recording (PUNCH IN/OUT)

Using OVER WRITE recording in MTR mode, you can manually punch in and out.
Press the REC button during playback to start re-recording from that point.



Press the MENU button for more than 2 seconds, and start operation from the top screen.

Change the REC MODE to OVER WRITEP.053

Assign files to tracks

Playback



1 On the top screen select the track menu icon and press.

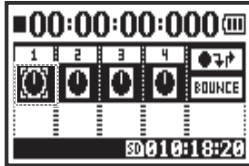

2 Select FILE and press.

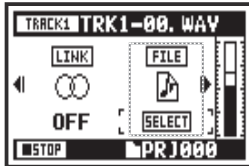

3 Select the desired file and press.

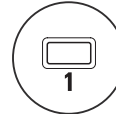

4 Press to enter recording standby.

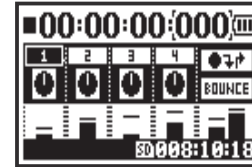

5 Press to start playback.

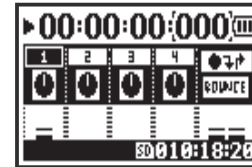

Re-recording (manually punching in/out)



6 Perform (not recording).



7 Press to start recording.

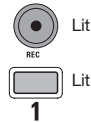
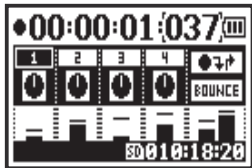

8 Perform (recording).

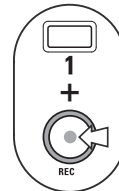

9 Press to finish recording.



10 Press to stop playback.

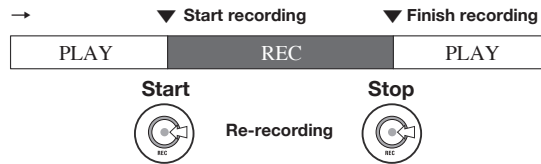
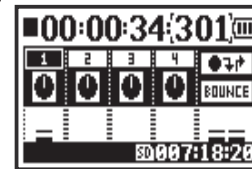

2-01-1 Recording functions: AUTO REC



The H4n Pro can detect when the input level exceeds a preset level and automatically start recording from recording standby.

STEREO **4 CH** Press the MENU button for more than 2 seconds, and start operation from the top screen.

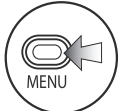

1 Press.



2 Select REC and press.

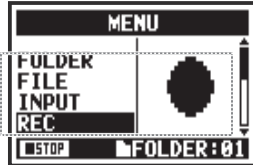

3 Select AUTO REC and press.

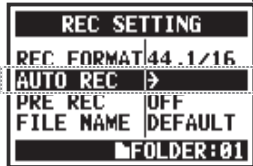

4 Select START LVL (starting level) and press.

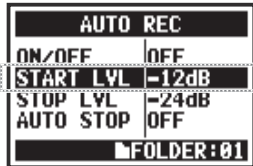

5 Adjust the level.

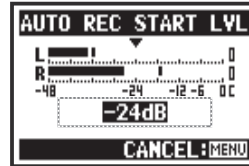

Set the input level that will start recording automatically.



6 Select ON/OFF and press.

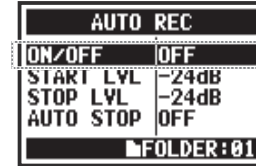

7 Select ON and press.



HINT:

“Wait for Signal” message

If the AUTO REC function is ON, “Wait for Signal” appears when in recording standby. The unit is sensing whether the input level exceeds the recording start level.

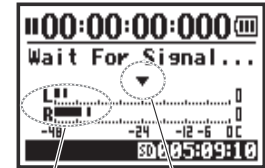

Current input level

Start level

When “Wait for Signal” appears, you can press the REC button to start recording manually.

NOTE:

- You cannot make this setting during recording or playback.
- You cannot use this function together with REC LEVEL AUTO, PRE REC or PRE COUNT.

2-01-2 Recording functions: AUTO REC STOP



When AUTO REC is ON and the H4n Pro is recording, it will automatically stop when the input level goes below the preset level.

STEREO **4 CH** Press the MENU button for more than 2 seconds, and start operation from the top screen.



1 Press.



2 Select REC and press.

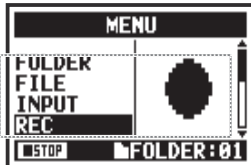

3 Select AUTO REC and press.

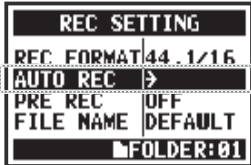

4 Select STOP LVL (stop level) and press.

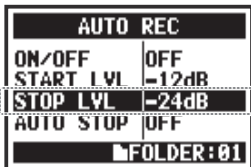

5 Adjust the level.

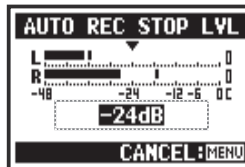

Set the input level at which recording will stop

HINT:

When AUTO STOP is on, a stop level indicator appears during recording.



6 Select AUTO STOP and press.

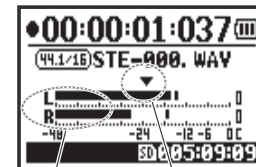
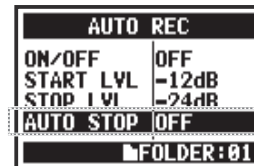

Stop level
Current input level



7 Set the time.



Set the time (1-5 seconds) until recording stops after the level becomes lower than the STOP LEVEL.

HINT:

- You cannot make this setting during recording or playback.
- Even when AUTO STOP is on, you can press the STOP button to stop recording.

2-02 Recording functions: PRE REC



When PRE REC is ON, up to 2 seconds before the REC button is pressed will automatically be captured in the recording.

Press the MENU button for more than 2 seconds, and start operation from the top screen.

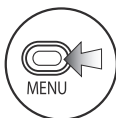

1 Press.



2 Select REC and press.

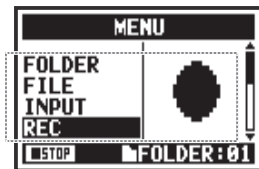

3 Select PRE REC and press.

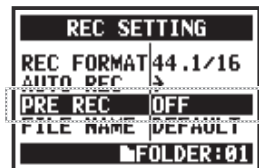

4 Select ON and press.

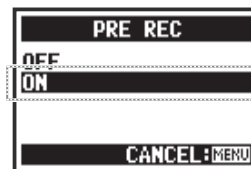

HINT:

When PRE REC is ON, the H4n Pro will pre-record audio two seconds before the record button is pressed.



NOTE:

- You cannot make this setting during recording and playback.
- When recording at 96 kHz in 4CH mode, the maximum PRE REC time is one second.
- You cannot use this function together with AUTO REC and PRE COUNT.

2-03 Recording functions: LO CUT



The LO CUT filter setting allows you to eliminate wind or blowing noises.

  Press the MENU button for more than 2 seconds, and start operation from the top screen.

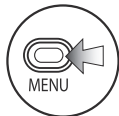

1 Press.



2 Select INPUT and press.

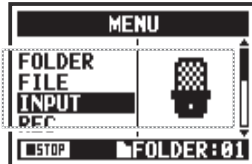

3 Select LO CUT and press.

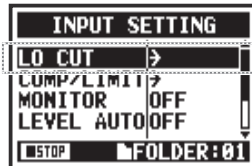

4 Select the input source and press.

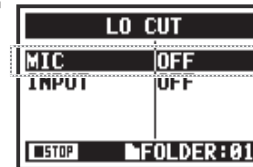

5 Select the cutoff frequency and press.



HINT:

- You can select from eleven LO CUT filter frequencies: OFF, 80, 98, 115, 133, 150, 168, 185, 203, 220, and 237 Hz. When using higher values, you should test the effect before recording.
- The smaller the number, the lower the cut-off frequency.

2-04 Recording functions: COMP/LIMIT

The COMP/LIMIT function can compensate for volume differences. For each input source, low-level input signals are raised and high-level input signals are lowered when recording.

STEREO **4 CH** Press the MENU button for more than 2 seconds, and start operation from the top screen.

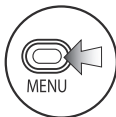

1 Press.



2 Select INPUT and press.

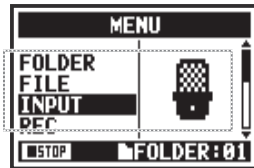

3 Select COMP/LIMIT and press.

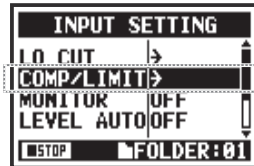

4 Select the setting input source.

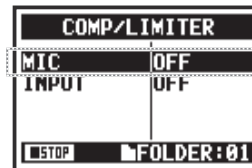

5 Select the setting target.

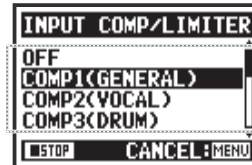

HINT

Type	Explanation		Threshold (dB)	Ratio	Output level (dB)	Attack time (ms)	Release time (ms)
OFF	Compressor and limiter OFF		-	-	-	-	-
COMP1 (GENERAL)	Standard compressor	These compressors reduce high-level sounds and raise the minimum level.	-48.7	9:1	+6.0	7.2	968
COMP2 (VOCAL)	This compressor is good for vocals.		-8.4	16:1	0	1.8	8.7
COMP3 (DRUM)	This compressor is good for drums and percussion.		-48.2	7:1	+3.6	12.3	947
LIMIT1 (GENERAL)	Standard limiter	Limiters compress when input signals exceed the fixed level.	-14.4	60:1	0	6.4	528
LIMIT2 (CONCERT)	Limiter good for live performance		-13.8	32:1	+1.2	1.9	8.5
LIMIT3 (STUDIO)	Limiter good for studio recording		-12.0	8:1	+1.2	6.5	423

2-05 Recording functions: REC LEVEL AUTO



This function automatically sets the level for recording.

STEREO **4 CH** Press the MENU button for more than 2 seconds, and start operation from the top screen.

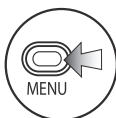

1 Press.



2 Select INPUT and press.

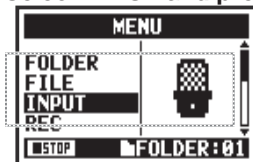

3 Select LEVEL AUTO and press.

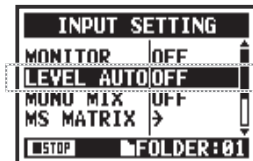

4 Select ON.



HINT:

When REC LEVEL AUTO is used, the unit automatically sets recording levels using signals present during recording standby. If the volume surpasses 6 dB during recording, the input level is automatically adjusted with the new level shown on the screen for two seconds.

Display in recording standby

Current input level

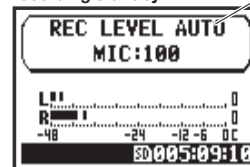

Stereo mode

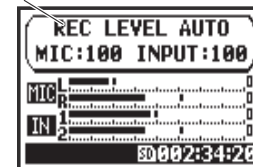

4CH mode

Display when -6 dB is exceeded while recording

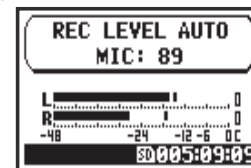

NOTE:

- You cannot use this function together with AUTO REC.
- You cannot make this setting during recording and playback.

2-06 Recording functions: MONITOR



Turning on the MONITOR function allows you to monitor input signals at all times.

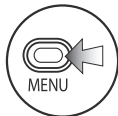

1 Press.



2 Select INPUT and press.

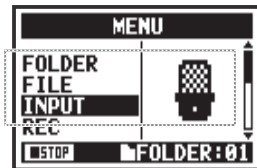

3 Select MONITOR and press.

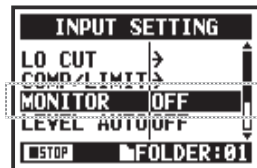

4 Select ON and press.

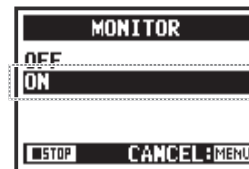

HINT:

You can always monitor the input source through the LINE/PHONE stereo out mini jack when in recording standby.

NOTE:

You cannot monitor input sounds through the built-in speaker.

2-07 Recording functions: INPUT 1/2 LEVEL LINK



The recording levels for INPUT 1 and 2 can be set separately.
This is useful when connecting different types of mics to these jacks.

STEREO **4CH** **STAMINA** Press the MENU button for more than 2 seconds, and start operation from the top screen.

Preparation

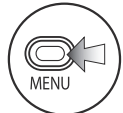

1 Press.



2 Select INPUT and press.

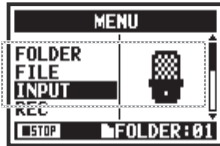

3 Select 1/2 LINK.

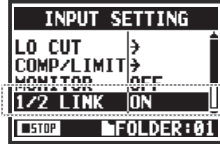

4 Select OFF and press.

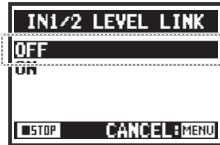

Set recording levels separately

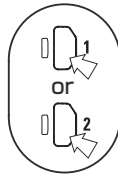

5 Press INPUT 1 or INPUT 2.

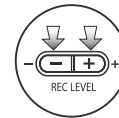

8 Use the REC LEVEL buttons to adjust the recording level.

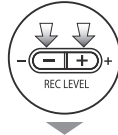
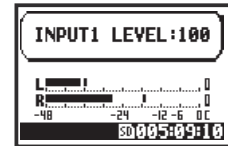

6 Press the REC LEVEL buttons.

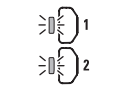

7 Press the button for the input to adjust.

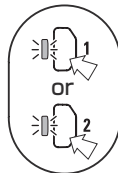

NOTE:

This function can be used in STEREO, 4CH and STAMINA modes only when MS MATRIX and MONO MIX are OFF.

2-08 Recording functions: MONO MIX



 Press the MENU button for more than 2 seconds, and start operation from the top screen.

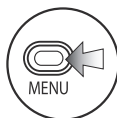

1 Press.



2 Select INPUT and press.

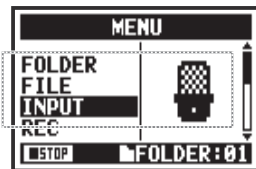

3 Select MONO MIX and press.

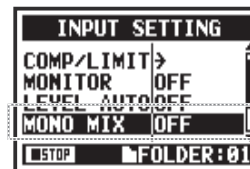

4 Select ON and press.





NOTE:

- The names of files recorded with MONO MIX are formatted like "MONO-xxx".
- You cannot use this function together with MS STEREO MATRIX.
- You cannot use this setting during recording and playback.

2-09 Recording functions: MS STEREO MATRIX

This function enables you to convert stereo microphone signals when using a mid-side recording configuration.

Press the MENU button for more than 2 seconds, and start operation from the top screen.

- 

1 Press.
- 

2 Select INPUT and press.

MENU

FOLDER	
FILE	
INPUT	[MIC]
REC	
[STOP] FOLDER:01	
- 

3 Select MS MATRIX and press.

INPUT SETTING

MONITOR	OFF
LEVEL AUTO	OFF
MONO MIX	OFF
MS MATRIX	>
[STOP] FOLDER:01	
- 

4 Make each setting accordingly.

MS STEREO MATRIX

ON/OFF	OFF
MID LEVEL	+0.0dB
SIDE LEVEL	+0.0dB
SOURCE	MIC
[STOP] FOLDER:01	

ON/OFF
Set MS STEREO MATRIX to ON or OFF.



Select

MS STEREO MATRIX

ON/OFF	OFF
MID LEVEL	+0.0dB
SIDE LEVEL	+0.0dB
SOURCE	MIC
[STOP] FOLDER:01	



Select

MS MATRIX ON/OFF

OFF	
ON	
[STOP] CANCEL:MENU	

MID LEVEL
Set the level of the directional MID mic that is pointed at the recording target.
Setting values: MUTE, -48.0 - +12.0 dB
Default: +0.0dB



Select

MS STEREO MATRIX

ON/OFF	OFF
MID LEVEL	+0.0dB
SIDE LEVEL	+0.0dB
SOURCE	MIC
[STOP] FOLDER:01	



Adjust

MID LEVEL

+0.0dB	
[STOP] CANCEL:MENU	

073

Operations / Recording functions: MS STEREO MATRIX

SIDE LEVEL

Set the level of the bidirectional SIDE mic, which is perpendicular to the MID mic.
Setting values: MUTE, -48.0 - +12.0dB
Default: +0.0dB

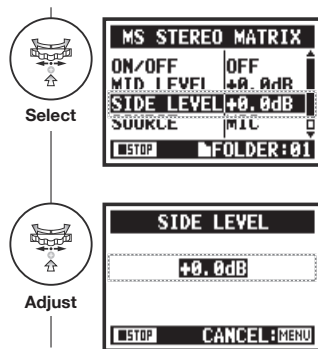

SOURCE

Set the input used (only in 4CH mode).

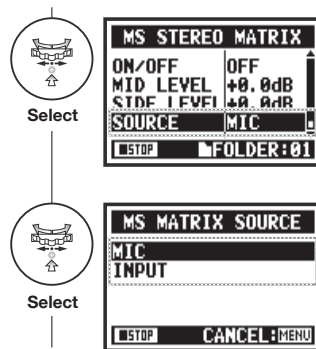

CH SETTING

Assign the MID and SIDE inputs to the left (INPUT 1) and right (INPUT 2) channels.

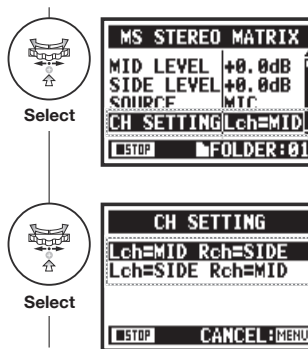

NOTE:

You cannot use this function together with MONO MIX.

NOTE

MS stereo format overview

This technique converts input from a directional mid mic, which captures sound in the center, and a bidirectional side mic, which captures sounds from the left and right, to stereo. You can change the stereo width as you like by adjusting the side mic level. Since this technique can capture a wide stereo image, it is

ideal for recording large open spaces with numerous sound sources, including orchestras, live concerts and soundscapes. This technique is also extremely effective when you want to adjust room ambience. Since it offers a high degree of freedom, it is used not only for studio recording but also for a wide range of recording—even of rehearsals and live performances.

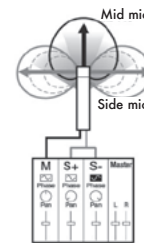

3-01-1 Tuner: CHROMATIC TUNER



The H4n Pro features a tuner with multiple tuning modes.

Press the MENU button for more than 2 seconds, and start operation from the top screen.

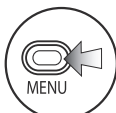

1 Press.



2 Select TOOL and press.

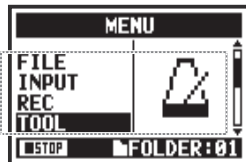

3 Select TUNER and press.

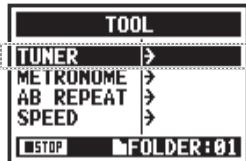

4 Select CHROMATIC and press.

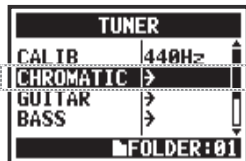

5 Tune the instrument.

The indicators show whether the input signals are higher or lower than the note shown. Both marks light when the input signal matches the note.

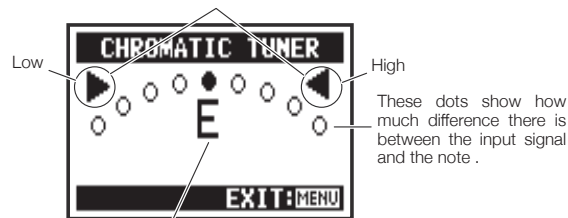

This shows the name of the note nearest to the input signal.

HINT:

- The input source signal that is currently selected is used for tuning.
- In 4CH mode, at Step 4 select INPUT and set the input source, and then continue to step 5.

NOTE:

This cannot be used during recording and playback.

Ref. Tuner display

String number/note name

P.078

3-01-2 Tuner: other TUNER types



In addition to CHROMATIC, the other tuning modes are GUITAR, BASS, OPEN A, OPEN D, OPEN E, OPEN G and DADGAD.

STEREO **4 CH** **MTR** Press the MENU button for more than 2 seconds, and start operation from the top screen.

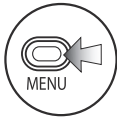

1 Press.



2 Select TOOL and press.

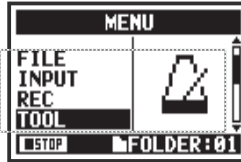

3 Select TUNER and press.

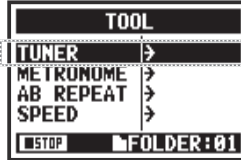

4 Select the tuning mode and press.

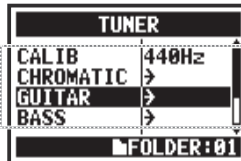

5 Tuning.

The indicators show whether the input signals are higher or lower than the note shown. Both marks light when the input signal matches the note.

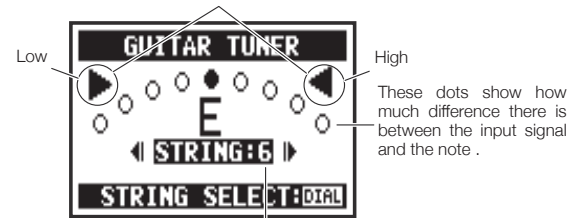

This is the string number currently selected. Use the DIAL to change it.

HINT:

- The input source signal that is currently selected is used for tuning.
- In 4CH mode, at Step 4 select INPUT and set the input source, and then continue to step 5.

NOTE:

This cannot be used during recording and playback.

Ref. Tuner display
String number/note name **P.078**

3-01-3 Tuner: TUNER CALIB



This function allows you to calibrate the tuner.

STEREO **4CH** **MTR** Press the MENU button for more than 2 seconds, and start operation from the top screen.

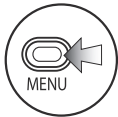

1 Press.



2 Select TOOL and press.

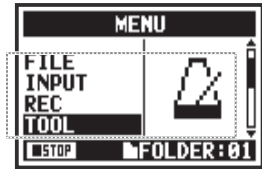

3 Select TUNER and press.

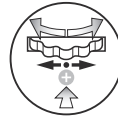
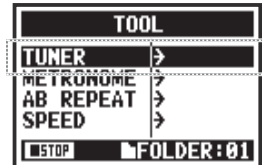

4 Select CALIB and press.

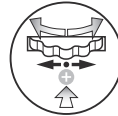
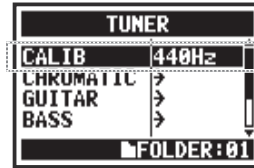

5 Select the frequency.

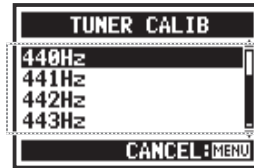

HINT:

- The default setting is 440Hz.
- Set this between 435Hz and 445Hz in 1Hz increments.

NOTE:

This cannot be used during recording and playback.

▶ Use steps 1-3 for all TUNER operations.

3-01-4 Tuner: TUNER INPUT

In 4CH mode you can select the input source for the tuner.

 Press the MENU button for more than 2 seconds, and start operation from the top screen.

TUNER ... P.075



4 Select INPUT and press.

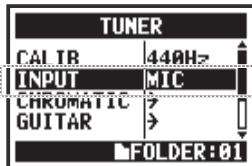

5 Select the input source and press.

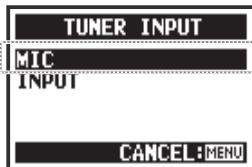

HINT:   

Tuner display

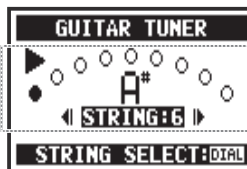

When pitch is low

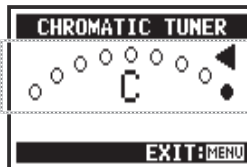

When pitch is high

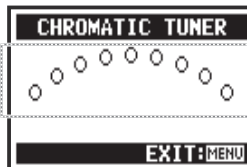

No input sound (chromatic)

Tuner types and string notes

Tuner type	String number/note name						
	1	2	3	4	5	6	7
GUITAR	E	B	G	D	A	E	B
BASS	G	D	A	E	B		
OPEN A	E	C#	A	E	A	E	
OPEN D	D	A	F#	D	A	D	
OPEN E	E	B	G#	E	B	E	
OPEN G	D	B	G	D	G	D	
DADGAD	D	A	G	D	A	D	

NOTE:

This cannot be used during recording and playback.

3-02 Metronome (METRONOME)

The metronome has convenient functions such as a pre-count.

STEREO **4CH** **MTR** Press the MENU button for more than 2 seconds, and start operation from the top screen.

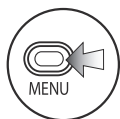

1 Press.



2 Select TOOL and press.

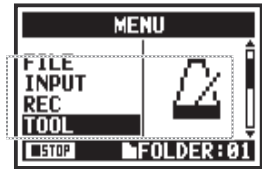

3 Select METRONOME and press.

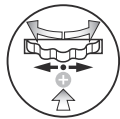
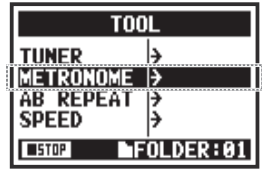

4 Set each item.

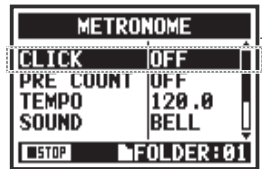

CLICK

This setting turns the metronome off or on during recording, playback or both. This setting must be made before recording or playback.



Select

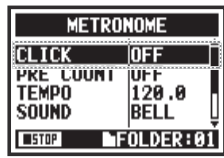

Select

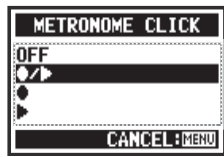

Select the condition

- OFF
- /▶ ---Recording/playback
- ---Only when recording
- ▶ ---Only when playback

PRE COUNT

Set the count used before recording starts. This cannot be set if PRE REC or AUTO REC is ON.



Select

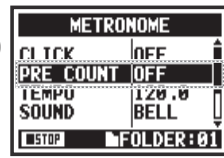

Select

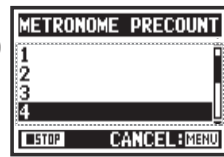

Set the count to OFF, 1-8 beats or SPECIAL.

Count of SPECIAL

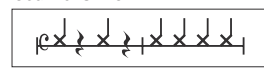

NOTE:

The metronome starts at the beginning of recording and playback. If you start in the middle of a song or track, the metronome beats may not be in sync with the song.

TEMPO

Set the metronome speed.



Select

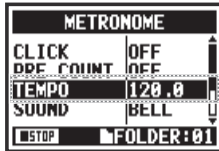

Adjust

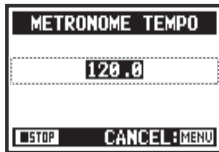

Default: 120.0

You can set this between 40.0 and 250.0 BPM in 0.1 increments.

SOUND

Set the metronome tone.



Select

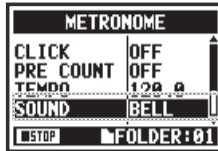

Select

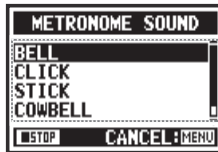

Default: bell

You can select BELL, CLICK, STICK, COWBELL or HI-Q.

PATTERN

Set the pattern of the metronome.



Select

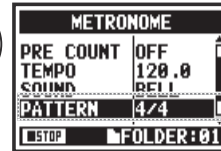

Select

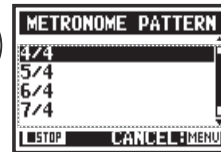

Default: 4/4.

You can this to 0/4 (no accent), 1/4 - 8/4 or 6/8.

LEVEL

Set the volume of the metronome.



Select

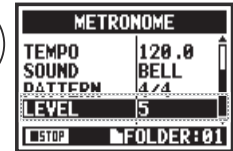

Select

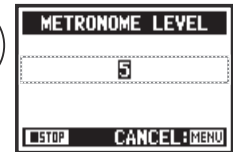

You can select from eleven levels.

3-03-1 Effects overview

This is an overview about how to use effects, including the process and input and output.

Effect use process

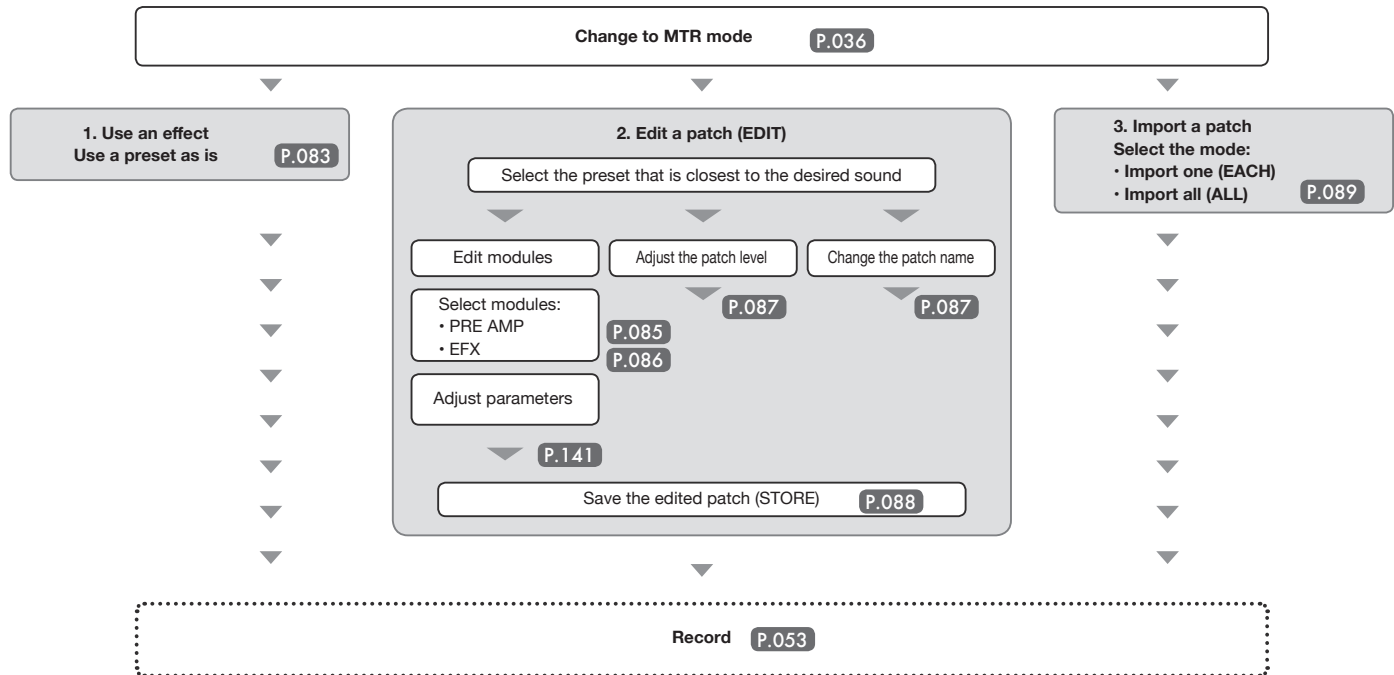

Effect input and output

You can use effects in MTR mode for mono and stereo signals. The flow of the signals will change according to the input sources and recording tracks.

One recording track

1. Input source is either INPUT 1 or 2



2. Input source is either MIC or INPUT 1 and 2

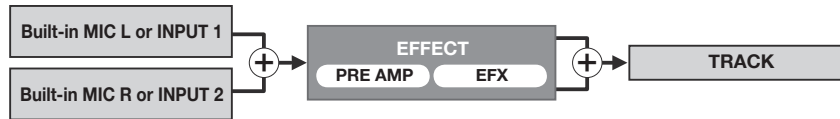

Two recording tracks

1. Input source is either INPUT 1 or 2



2. Input source is either MIC or INPUT 1 and 2

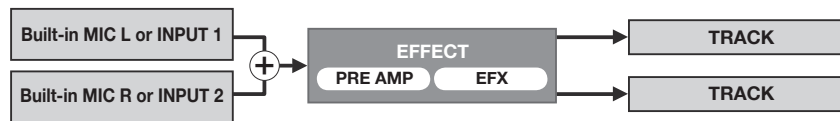

3-03-2 Effects (EFFECT)

Using the 2 EFFECT modules in MTR mode, you can add various effects to the input signals.

Operations / Effects (EFFECT)

Press the MENU button for more than 2 seconds, and start operation from the top screen.

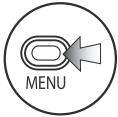

1 Press.



2 Select EFFECT and press.

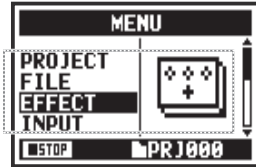

3 Press ON and press.



4 Select No.: (patch name) and press.

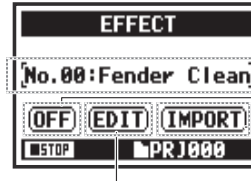

Patch number: patch name.

Turn EFFECT ON or OFF

IMPORT: Import a patch from another project

EDIT: Create a new patch or edit a patch

5 Select PATCH and press.

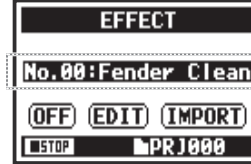

Ref.

Patch list

P.141

P.147

6 Press MENU for more than two seconds to return to the top screen.

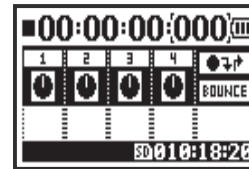

NOTE:

PATCH

Effects module settings are saved as a patch.

60 patches are available with 50 already programmed.

3-03-3 Patch editing (EFFECT EDIT)

You can create your own patch by combining effects and adjusting the parameter settings.

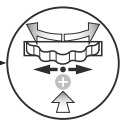

5 Select the desired No.:(patch name) and press.

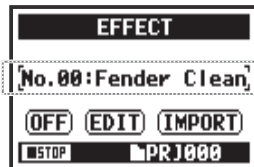

6 Select EDIT and press.

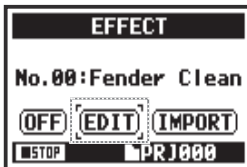

7 Select the parameter that you want to change and press.

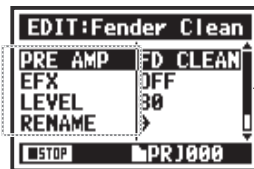

EDIT MENU

PRE AMP

The PRE AMP module has guitar and bass amp modeling effects.



LEVEL

Adjust the patch level.



RENAME

Change the patch name.



EFX

The EFX module has modulation, chorus and delay effects.

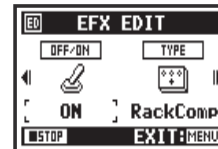

STORE

Save the edited patch.



3-03-4 PRE AMP module editing (EFFECT EDIT: PRE AMP)

MTR mode only



You can edit preset effect patches as you like.

Select the desired PATCH and edit it P.084

Adjust the PRE AMP module



7 Select PRE AMP and press.

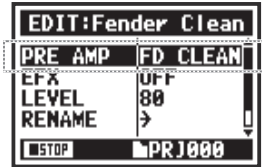

8 Press OFF/ON to turn the PRE AMP module on.

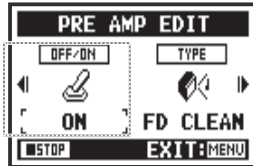

9 Select the parameter to edit and press.

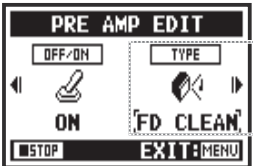

Adjust a parameter

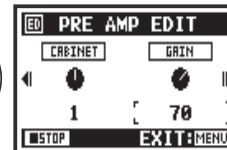
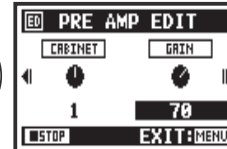
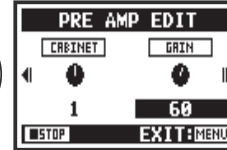
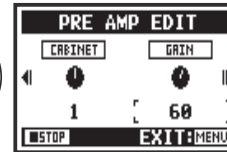

Icons



PRE AMP module
ON/OFF status



Set effect
AMP type



CABINET, EQ, LEVEL, etc.



ZNR icon

Ref.

PRE AMP module parameters

P.141

3-03-5 EFX module editing (EFFECT EDIT: EFX)

Edit patch parameters to make the sound closer to the desired effect.

Select a patch close to the desired sound and edit it....P.084

Adjust the EFX module



7 Select EFX and press.

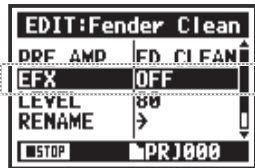

8 Press OFF/ON to turn the EFX module on.

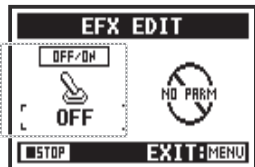

9 Select the parameter to edit and press.

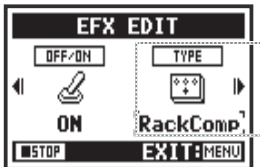

HINT:

To select PRE AMP and EFX modules, make setting after changing the module status ON.

Default: When a module is OFF, no parameters or settings are shown.

When OFF, you cannot select modules.



Icons



EFX module ON/OFF status



Set effect EFX type



Various parameters

Ref. 

EFX module parameters

P.143

3-03-6 EFFECT EDIT: LEVEL/RENAME

MTR mode only



Adjust the patch level and change the patch name.

EFFECT EDIT ... P.084

LEVEL

RENAME



1 Select LEVEL and press.

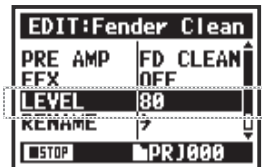

2 Change the number and press.



1 Select RENAME and press.

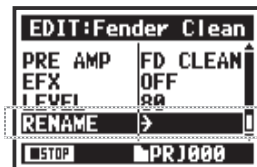

2 Change the PATCH name and press.



3 Select OK and press.



NOTE:

Select STORE to save the patch. To return to the top without saving the change, select MENU.

EFFECT EDIT ... P.084

STORE



10 Select STORE and press.

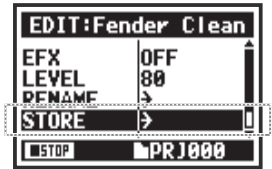

11 Select the PATCH No. where you want to save it and press.



12 Select EXECUTE and press.



HINT:

ED appears next to items you have edited until confirmed by the STORE operation.

Not stored (not saved)

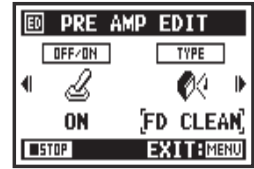

Confirm with STORE

Selecting “YES” will overwrite the current patch. To save without overwriting an existing patch, select an empty patch during the STORE operation. Patches are saved by project.

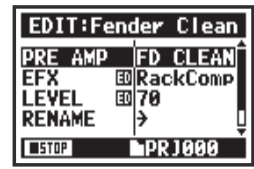

3-03-8 Importing patches from other projects (EFFECT IMPORT)

You can apply an edited and saved effect patch used in another project to the current project.

Select effect ... P.083 (EFFECT)

Import all patches (ALL)



- 1** Press **IMPORT** on the **EFFECT** screen.

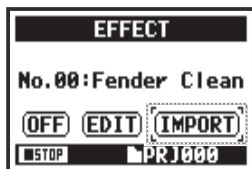

- 2** Select **MODE** and press.



- 3** Select the desired mode and press.



- 4** Select the project and press.



- 5** Select **NEXT** and press.



- 6** Select **YES** and press.

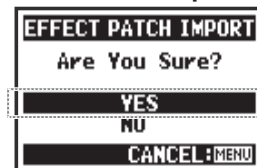

All the patches from the project selected at step 4 are imported into the current project.

Import one patch (EACH)



5 Select NEXT and press.

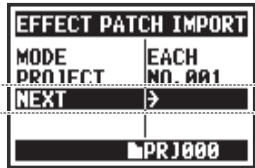

8 Select YES and press.

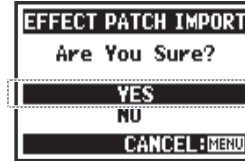

The patch selected in step 6 is imported into the current project.



6 Select a patch to import and press.

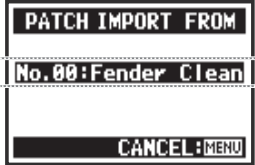

7 Select the patch you want to import it to in the current project and press.



NOTE:

If there is no other project when you press IMPORT, "No Other Project!" will appear.

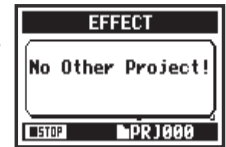

HINT:

- Import mode ▶
- Import project ▶
- Start importing ▶



Current PROJECT

3-04-1 Karaoke preparation (KARAOKE)

Use music files of your choice for karaoke, then record vocals or additional guitar sounds with those files.

Karaoke process

Preparation

Prepare stereo files for the background

Create a new project for karaokeP.118

Import the file to the project

- Copy the file to the project folderP.037
- Use the MOVE functionP.117

Karaoke setup

(Prepare tracks for karaoke)

1. Select a track menu icon and open the TRACK menu
2. Turn KARAOKE ON.
3. Assign files.

Adjust the karaoke tracks

- LEVEL
- CENTER CANCEL
- KEY
- FINE

Perform with karaoke

4. Connect a microphone
5. Make recording track settings
6. Enable recording
 - Playback
 - Record



Press the MENU button for more than 2 seconds, and start operation from the top screen.

Karaoke track preparation



- 1 Select a track menu icon and press.

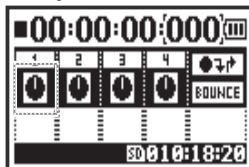

- 2 Select KARAOKE and press.



- 3 Select ON and press.

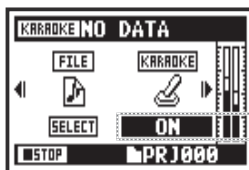

Assign the desired file to the KARAOKE track



- 4 Select the track menu icon and press.



- 5 Select FILE and press.

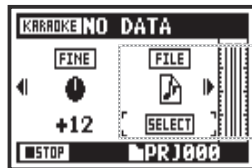

- 6 Select the desired file and press.



Continued on the next page →

Enable center cancelation on the KARAOKE track



7 Select the track menu icon and press.

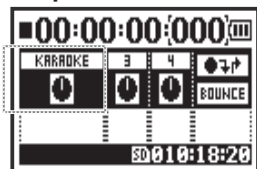

8 Select CNT CANCEL and press.

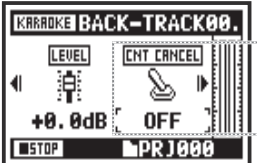

9 Select ON and press.

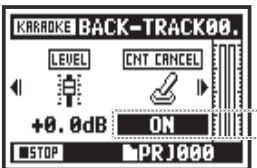

Change the key of the KARAOKE track



10 Select the track menu icon and press.



11 Select KEY and press.

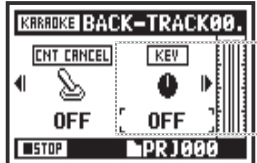

12 Adjust and press.

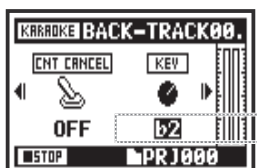

HINT:

The KARAOKE track menu has different contents than other tracks.

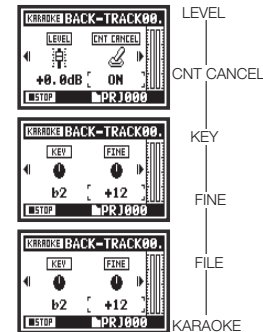

3-04-2 Karaoke recording (KARAOKE)

Fine adjustment of the KARAOKE track key



13 Select the track menu icon and press.

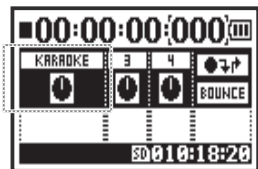

14 Select FINE and press.

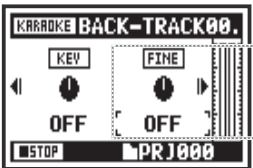

15 Adjust it and press.



Recording with KARAOKE

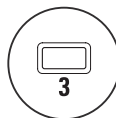

1 Connect a microphone.
Press the INPUT button corresponding to the connected input jack.

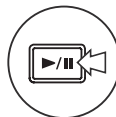

2 Select the track menu icon and press.

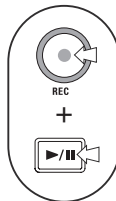
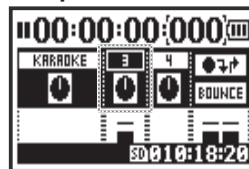

3 Press to practice (no recording).

4 Press the REC button to enter recording standby.
Then, press the PLAY/PAUSE button to start recording.

NOTE:

You cannot use this function together with the EFFECT.

Ref.  TRACK MENU

4-01 Playback: File Playback (STEREO, 4CH and STAMINA modes)



Immediately after recording, you can play the file by pressing the PLAY/PAUSE button.
Follow these steps to call up a file later for playback.

STEREO **4 CH** **STAMINA** Press the MENU button for more than 2 seconds, and start operation from the top screen.

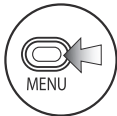

1 Press.



2 Select FILE and press.

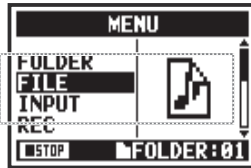

Shortcut

Press TRACK 2 on the top screen.



3 Select the desired file and press.

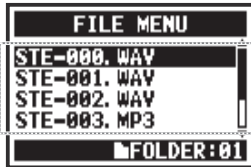

4 Select SELECT and press.

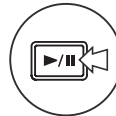

5 Press to start playback.

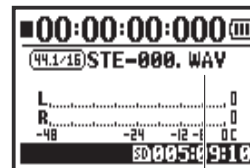

Shortcut

You can select files in folders on the top screen.



Confirm the file name.

HINT:

- On the top screen you can move directly to step 3, by pressing the TRACK 2 button."
- If you press the PLAY/PAUSE button after selecting a file, that file starts playback immediately.
- You can select files in folders directly using the DIAL on the top screen.

Ref.

FILE SELECT P.104

4-02 Playback: PLAY MODE



In addition to ordinary playback, you can also play just one file, repeat playback of one file, and repeat playback of all files.

STEREO **4 CH** **STAMINA** Press the MENU button for more than 2 seconds, and start operation from the top screen.

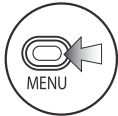

1 Press.



2 Select PLAY MODE and press.

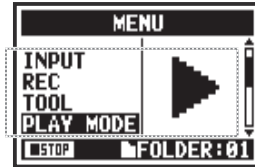

3 Select a play mode and press.



Select the desired mode.

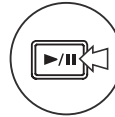

4 Press to start playback.

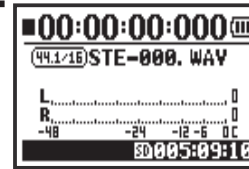

PLAY ALL	Play all the files in the folder.
PLAY ONE	Play one file.
REPEAT ONE	Play one file repeat repeatedly.
REPEAT ALL	Play all files in the folder repeatedly.

NOTE:

You cannot change this setting during recording and playback.

4-03 Playback: Setting marks



During file playback you can add marks at desired points.
You can move easily to those points during playback.

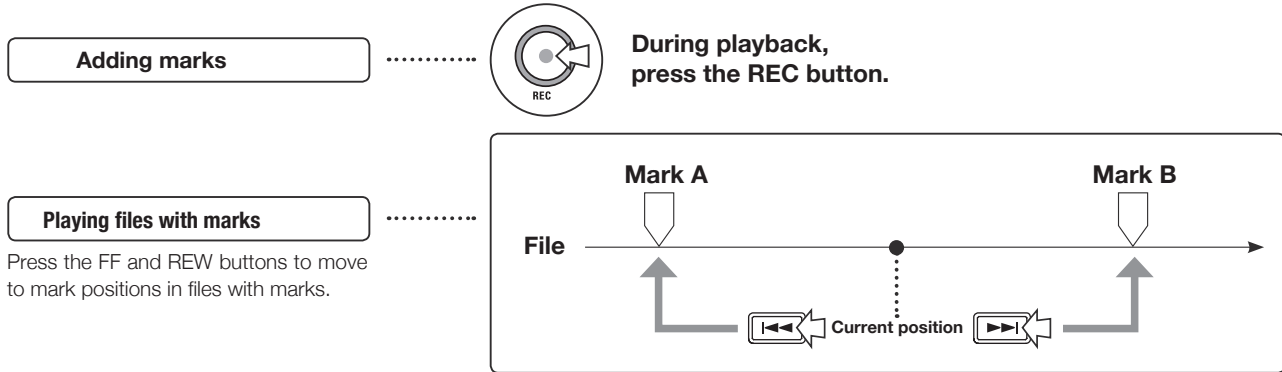

NOTE:

- The mark function can only be used for WAV format files.
- The maximum number of marks in one file is 99.
- Once a mark has been created it cannot be deleted.

HINT:

- Press the REC button during recording to add a mark.
- You can check marks in the file in the MARK LIST.



Ref.  MARK LIST P.115

4-04 Playback: AB REPEAT

The AB REPEAT function allows you to play between two points in a file repeatedly.

STEREO **4 CH** Press the MENU button for more than 2 seconds, and start operation from the top screen.

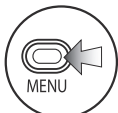

1 Press.



2 Select TOOL and press.

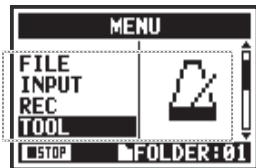

3 Select AB REPEAT and press.

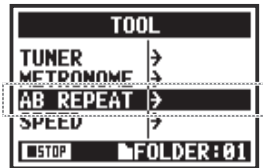

4 Press to start playback.

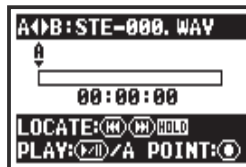

Point A moves.



5 Press to set point A.

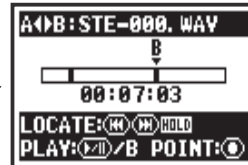
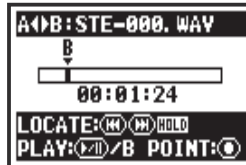

A mark is placed at point A, then mark B appears and moves until set.



6 Press to set point B.



Playback repeats between the points.

HINT:

You can also set point A and B while stopped.

NOTE:

During recording and playback, you cannot make any settings after Step 3 of AB REPEAT.

HINT:

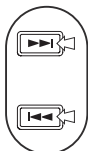

Press and hold to search.

Caution:

When moving around using FF and REW buttons, if you press the button for less than 2 seconds (quick press), it will move to the next file. If there is a mark, it will move to the next mark.

Press the FF and REW buttons for more than 2 seconds to search for a desired point.

After setting up A and B points, press the REC button to cancel all settings.

Button functions with AB REPEAT

Set/clear A and B points	
Stop	
Play/Pause the file	
Hold for more than one second to search backward or forward	
Press briefly to skip to the next file in order (If there is a mark in a WAV file, however, this will move to the nearest mark instead)	

4-05 Playback: SPEED

You can adjust the playback speed of a file.



Press the MENU button for more than 2 seconds, and start operation from the top screen.

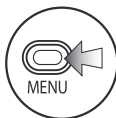

1 Press.



2 Select TOOL and press.

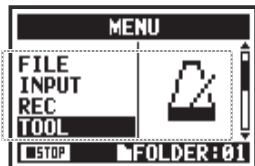

3 Select SPEED and press.

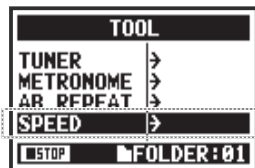

Shortcut

Press TRACK 3 on the top screen.



4 Adjust the playback speed.

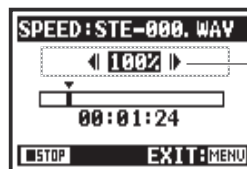

You can set the playback speed between 50% and 150% in increments of 5%.



5 Press to start playback.

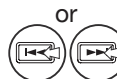
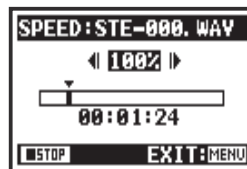

NOTE:

During recording and playback, you cannot make any settings after Step 3 of SPEED.

HINT:

- You can open this menu quickly by pressing the TRACK 3 button on the top screen of the mode.
- You can set the playback speed between 50% and 150% in increments of 5% (default: 100%).
- You can move the playback location using the FF and REW buttons.

4-06 Playback: MIXER

In 4CH mode you can use the mixer to adjust the playback LEVEL and PAN settings of two stereo files.



Press the MENU button for more than 2 seconds, and start operation from the top screen.

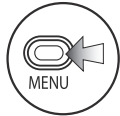

1 Press.



2 Select MIXER and press.

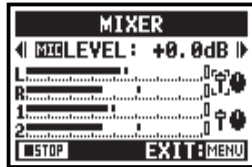
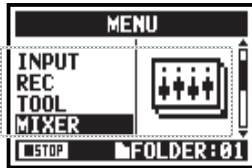

LEVEL setting



MUTE, -48.0dB –
+12.0dB
(default: 0.0dB)

Shows if you are setting a
MIC or INPUT track

Name of parameter where cursor is
positioned and its setting value



Fader icon

Pan pot icon

Cursor shows
parameter selected

After setting, confirm with icons

PAN setting



L 100 – C – R 100
(default: C (center))

HINT:

The cursor cycles on the MIXER screen from MIC LEVEL to MIC PAN to INPUT LEVEL to INPUT PAN.

4-07 Playback: Playing files (MTR mode)

MTR mode has various ways to play files. You can, for example, create and record files separately, assign them to tracks and play them back simultaneously.

Operations / Playback: Playing files (MTR mode)

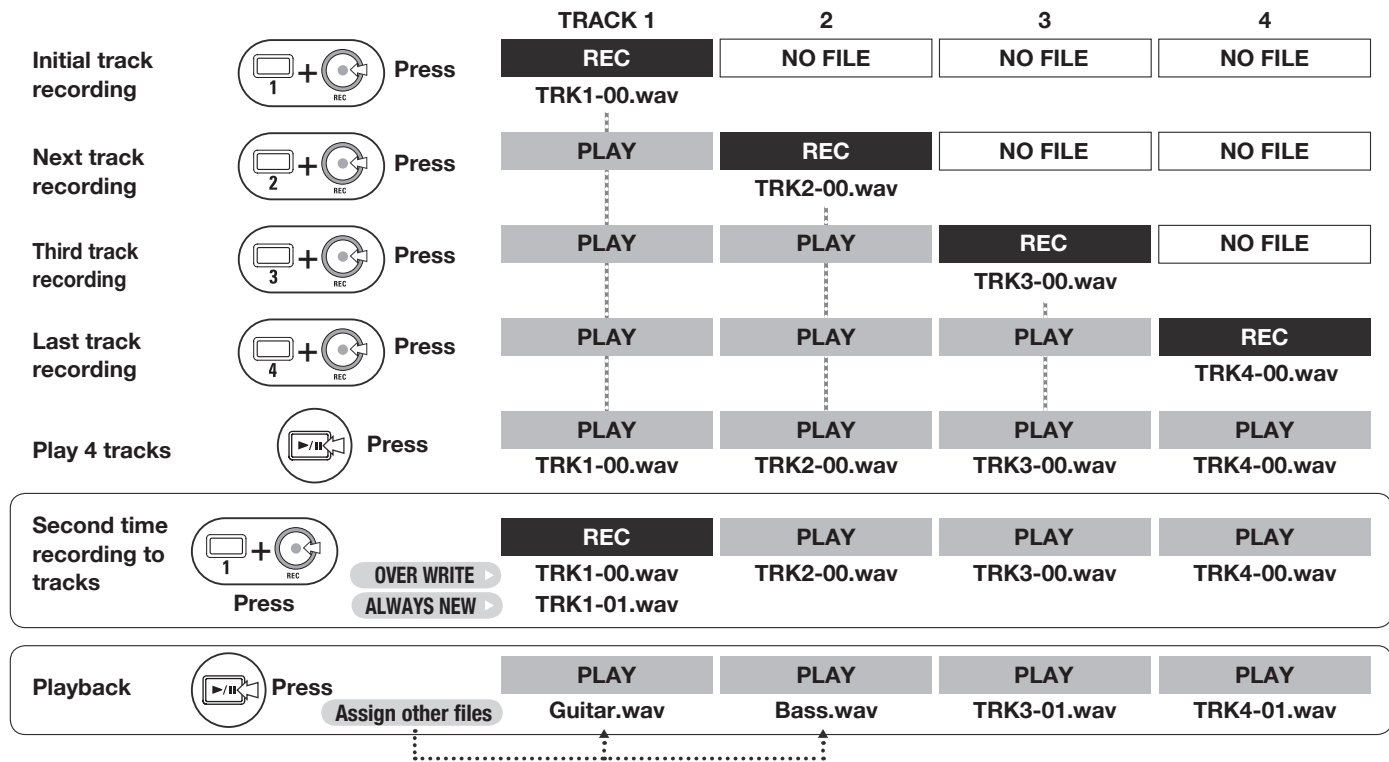

4-08 Playback: Specifying a counter time

Using the counter, you can specify any desired point in a recording.

 Press the MENU button for more than 2 seconds, and start operation from the top screen.



1 Select the counter on the top screen and press.

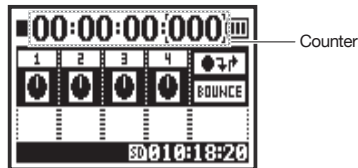

HINT:



Hour: minute: second: millisecond



2 Select the time to set (hour, minute or second).



3 Change the value and press.

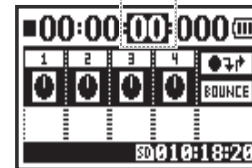

5-01 Editing/Output: FOLDER SELECT



Select the folder that contains the file you want to record with or play.

STEREO **4CH** **STAMINA** Press the MENU button for more than 2 seconds, and start operation from the top screen.

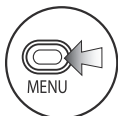

1 Press.



2 Select FOLDER and press.

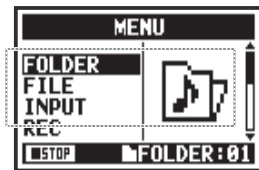

Shortcut

Press TRACK  1 on the top screen.



3 Select a folder and press.



Current folder

NOTE:

- You cannot use this setting during recording and playback.
- You can select any one of ten folders in STEREO, STAMINA and 4CH modes.

HINT:

You can open the FOLDER SELECT screen by pressing the TRACK 1 button on the top screen.

5-02 Editing/Output: FILE SELECT



You can select files for playback from a file list.

Press the MENU button for more than 2 seconds, and start operation from the top screen.

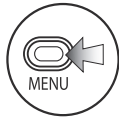

1 Press.



2 Select FILE and press.

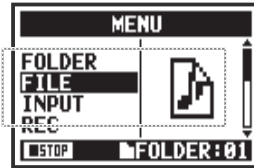

Shortcut

Press TRACK 2 on the top screen.



3 Select a file and press.

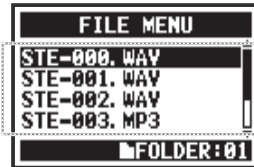

▶ All FILE operations are the same to here



4 Select SELECT and press.

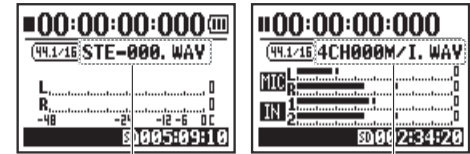
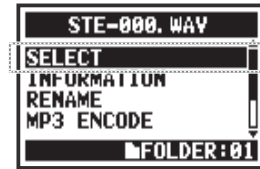

Verify the file name.

HINT:

- You can also select files in the folder directly using the DIAL on the top screen.
- You can press the TRACK 2 button on the top screen to jump to file selection in step 3.

5-03 Editing/Output: FILE INFORMATION



This function displays the selected file information.

Selecting files . . . P.104 FILE SELECT



4 Select **INFORMATION** and press.

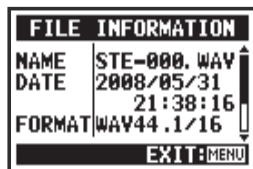

NAME	Name of file
DATE	Recorded date of file (or modification date when created by a computer or other device)
FORMAT	Format of file (in MTR mode, MONO or STEREO shown)
SIZE	File size (kB or MB)
TIME	Recording time of file

5-04 Editing/Output: FILE DELETE



You can delete a selected file.

Selecting files . . . P.104 FILE SELECT



4 Select DELETE and press.



5 Select YES and press.



NOTE:

Be careful!

Once deleted, a file cannot be recovered.

5-05 Editing/Output: FILE DELETE ALL



You can delete all the files in a folder or project.

Selecting files . . . P.104 FILE SELECT



4 Select DELETE ALL and press.



5 Select YES and press.



The name of the folder or project selected. All files in it will be deleted.

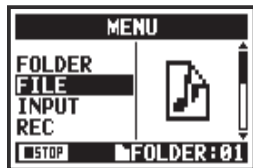

NOTE:

Be careful!

Once deleted, files cannot be recovered.

5-06 Editing/Output: FILE COPY

In MTR mode you can copy files. The copies are saved in the same project as the original files. This function is useful when you want to preserve the original copy.

 Press the MENU button for more than 2 seconds, and start operation from the top screen.

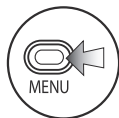

1 Press.



2 Select FILE and press.

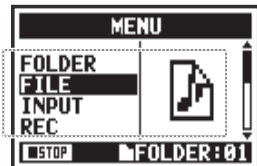

3 Select the desired file and press.



4 Select COPY and press.

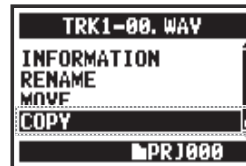

5 Select EXECUTE and press.

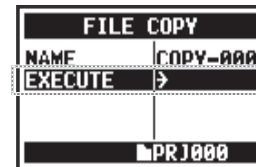

HINT:

Changing file names: The default name given to copied files is COPY-XXX. You can change it if necessary.



Ref.  FILE RENAME

P.109

5-07 Editing/Output: FILE RENAME

In STEREO, MTR and STAMINA modes, you can change the names of files.
If recorded in 4CH mode, file names cannot be changed.

Selecting files . . . P.104 FILE SELECT



4 Select RENAME and press.



6 Input a character and press.



Select a character with the DIAL



5 Select a character and press.



Select a character to change



7 Press.



Press the DIAL to confirm the change.



Press the DIAL to highlight the character



8 Select OK and press.



HINT:

Display when more than 12 characters

When the name of a file has more than 12 characters, a triangle mark appears showing that letters that can be selected are off the screen.

When changing letters, they appear in the following order.

(space)!#\$%&()+,-01234
56789;=@ABCDEFGHIJ
KLMNOPQRSTUVWXYZ
^_`abcdefghijklmnopqrstuvwxyz`~

NOTE:

If two files in the same folder would have the same name, "This File Name Already Exists!" appears on the display, and the previous screen reopens and you will need to change the name.



5-08 Editing/Output: FILE MP3 ENCODE

STEREO mode only



In STEREO mode you can convert WAV files to MP3 format at various bit rates.

Selecting files . . . P.104 FILE SELECT



4 Select MP3 ENCODE and press.



5 Select BIT RATE and press.

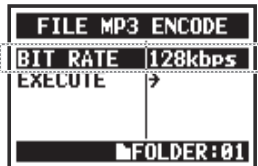

6 Select the desired bit rate and press.

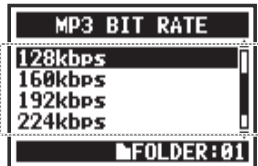

7 Select EXECUTE and press.

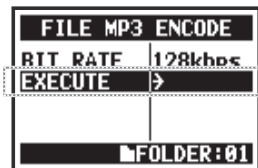

HINT:

- The name of the encoded file automatically becomes "(original file name).mp3".
- You cannot have two files with the same name. If the screen says, "File Name Exists!" select RENAME and create a different name.

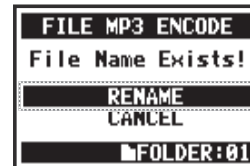

Bit rate that can be selected (kbps)	48, 56, 64, 80, 96, 112, 128, 160, 192, 224, 256, 320, VBR (default: 128 kbps)
--------------------------------------	--

Ref. FILE RENAME P.109

5-09 Editing/Output: FILE NORMALIZE



This function automatically adjusts the volume level of a recorded file for enhanced sound quality and audio consistency.

Selecting files . . . P.104 FILE SELECT



4 Select NORMALIZE and press.



5 Select YES and press.

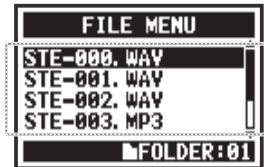

NOTE:

NORMALIZE function is only available for files recorded in WAV format

5-10 Editing/Output: FILE STEREO ENCODE

This function will mix down a 4CH file to a stereo file. The file will be saved in the folder in STEREO mode.

Selecting files . . . P.104 FILE SELECT

Select STEREO ENCODE

Setup MIXER:

Enable the MIXER before encoding.



4 Select STEREO ENCODE and press.

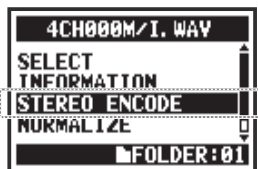

5 Select MIXER and press.

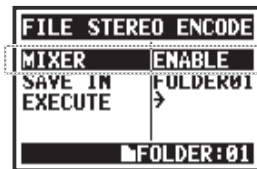

6 Select and press.

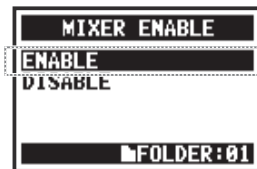

Ref. 

MIXER P.100

ENABLE Use MIXER settings.

DISABLE Do not use MIXER settings. Two files are mixed equally.

Select SAVE IN

Select the STEREO mode folder where you want to save the encoded file.

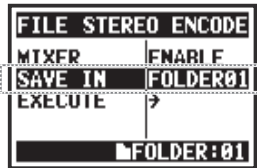
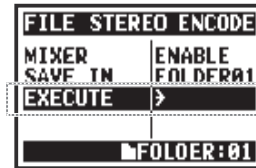
**7** Select **SAVE IN** and press.**8** Select the folder to save in and press.**Execute****9** Select **EXECUTE** and press.**HINT:**

You cannot have two files with the same name. If the screen says “File Name Exists!” select **RENAME** and change the name.

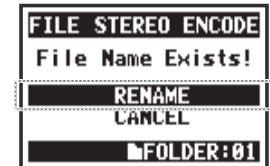

The encoded file is stored in the folder.

The file name automatically given is the same as the one in 4CH mode but M/I is changed to MIX.

Ref. 

MIXER P.109

5-11 Editing/Output: MARK LIST



You can view a list of the marks put in a WAV file.

Selecting files . . . P.104 FILE SELECT



4 Select MARK LIST and press.



— This mark shows a sound dropout.
 — This mark is user created.

NOTE:

The H4n Pro will automatically place a mark at point where sound drops out during recording.

HINT:

If there are no marks in the file, “No Mark!” will appear on the display.



Sound dropouts (skipping) with SD cards

When recorded data is transferred to an SD card, sometimes the processing speed is not fast enough and the sound drops out.

The processing speed depends on the mode, REC FORMAT setting, type of SD card, etc. If the processing load is light, sound dropouts rarely happen,

but if the load is heavy, they often happen. In this case, change the REC FORMAT to a lighter setting.

	Stereo mode	4CH mode
Heavy ▲	WAV96kHz/24bit WAV96kHz/16bit	WAV48kHz/24bit WAV44.1kHz/24bit WAV48kHz/16bit WAV44.1kHz/16bit
▼ Light	WAV48kHz/24bit WAV44.1kHz/24bit WAV48kHz/16bit WAV44.1kHz/16bit MP3	

Ref. REC FORMAT **P.049**
 Setting marks **P.096**

5-12 Editing/Output: DIVIDE

In STEREO MODE, you can divide files at any desired position.

Selecting files . . . P.104 FILE SELECT



4 Select DIVIDE and press.

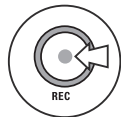

6 Press at the desired division point.

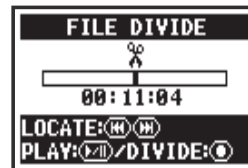

5 Press to start playback.

Current file position

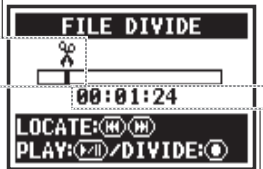

Current file time



7 Select Yes and press.



Operation of buttons with DIVIDE function

DIVIDE	
Play or pause the file	
Holding for more than one second to search forward/backward	
Press briefly to skip one second or jump to the next mark in a file with marks.	

HINT:

The DIVIDE operation creates 2 files. "A" will be added to the end of the file name of the first part and "B" will be added to the second.

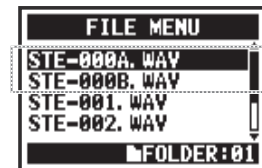

5-13 Editing/Output: MOVE



This function is used to move files to different folders and modes.

Selecting files . . . P.104 FILE SELECT



4 Select MOVE and press.

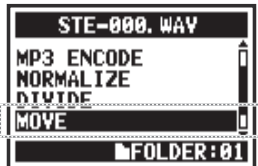

5 Select MOVE TO and press.

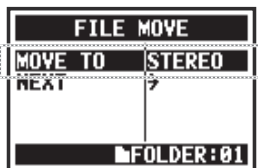

6 Select the destination.



7 Select NEXT and press.

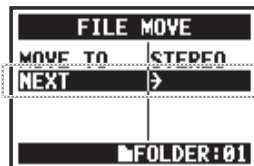

8 Select the destination folder (project).

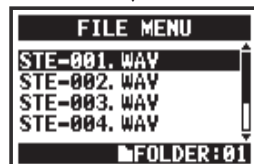
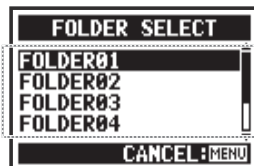

Ref.
 REC FORMAT P.118
 FILE RENAME P.109

HINT:

Movable file formats

- Only stereo files can be moved to a stereo folder. Mono files cannot be moved to stereo folders.
- Only 4CH files can be moved to 4CH folders.
- Only 44.1kHz/16bit files can be moved MTR projects.
- If you try to move a file in another format, "44.1 kHz/16 bit WAV Format Only!" will appear on the screen.



MOVE TO MTR PROJECT

To move a folder to an MTR project, a project folder must exist. If there is no project folder, "No Project!" will appear on the screen.



5-14 Editing/Output: NEW PROJECT

In MTR mode, settings, including for audio tracks and effects, are saved in projects. First, we will make a new project



Press the MENU button for more than 2 seconds, and start operation from the top screen.

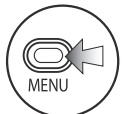

1 Press.



2 Select PROJECT and press.

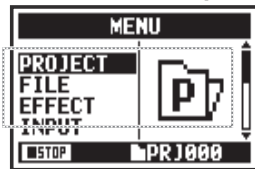

3 Select NEW PROJECT and press.



4 Select EXECUTE and press.

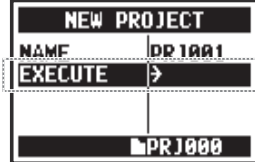

HINT:

To change the name of the new project.



Select NAME and press.

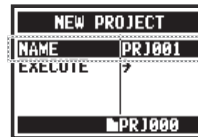

Select a letter to change and press.



Select OK and press.



Project numbering

- The H4n Pro numbers new projects automatically.
- You cannot change this number.
- You can use the same name in multiple projects

Maximum number of projects

You can create a maximum of 1000 projects. Each project name can be up to 8 characters long.

(space)!"#\$%&()*+,-./0123456789;:=?@ABCDEF
GHIJKLMNOPQRSTUVWXYZ \ ^ _ `abcdefghijklmnopqrstuvwxyz{|}~

Characters are changed in the order above.

5-15 Editing/Output: PROJECT SELECT

MTR mode only



Select a project stored on the SD card.



Press the MENU button for more than 2 seconds, and start operation from the top screen.

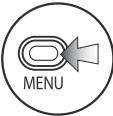

1 Press.



2 Select PROJECT and press.

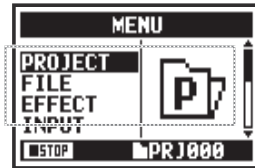

3 Select SELECT and press.



4 Select the desired project and press.

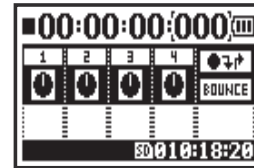

Operations / Editing/Output: PROJECT SELECT

5-16 Editing/Output: PROJECT DELETE

This function will delete a project.

 Press the MENU button for more than 2 seconds, and start operation from the top screen.



1 Press.



2 Select PROJECT and press.

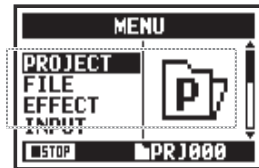

3 Select DELETE and press.



4 Select a project to be deleted and press.

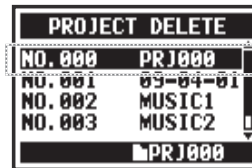

5 Select YES and press.



NOTE:

Once deleted, you cannot restore a project.

HINT:

You cannot delete a protected project. You need to end protection before deletion.

Ref.  PROTECT P.125

5-17 Editing/Output: PROJECT RENAME

MTR mode only



You can change the name of a project.



Press the MENU button for more than 2 seconds, and start operation from the top screen.

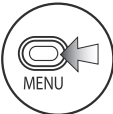

1 Press.



2 Select PROJECT and press.

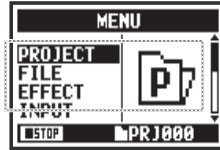

3 Select RENAME and press.



4 Select the project with the name to change and press.

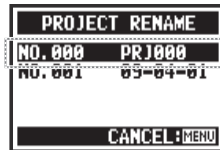

5 Select a letter to change and press.



6 Change the letter and press.



7 Select OK and press.



Characters are changed in the following order.

(Space)!*"#\$%&()*+,-./0123456789;:=
?@ABCDEFGHIJKLMN OPQRSTUVWXYZ
Z \ ^ _ ` abcdefghijklmnopqrstuvwxyz{|}~

HINT:

Project number

- The H4n Pro numbers new projects automatically.
- You cannot change the number.
- You can use the same name in multiple projects.

Operations / Editing/Output: PROJECT RENAME

5-18 Editing/Output: PROJECT COPY



You can copy a project to create a new project with a new number.

Select a project and start operation. . . P.119

MTR Press the MENU button for more than 2 seconds, and start operation from the top screen.

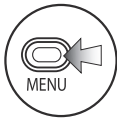

1 Press.



2 Select PROJECT and press.

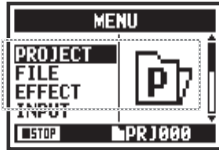

3 Select COPY and press.



4 Select EXECUTE and press.



HINT:

Change the number of the destination project

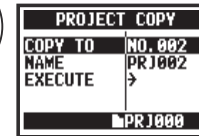

Automatically shows the lowest unused number

Change the name of the target project.



Ref. PROJECT (RENAME) P.121

5-19 Editing/Output: PROJECT BOUNCE

You can combine tracks created in MTR mode and mix them down to one mono or stereo track.

Select a project and start operation. . . P.119



Press the MENU button for more than 2 seconds, and start operation from the top screen.

Select BOUNCE



1 Select BOUNCE on the top screen and press.

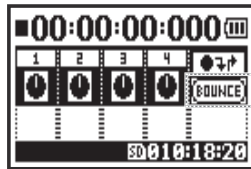

Set the bounce file name

Proceed to next step if no change. →

2 Select NAME and press.

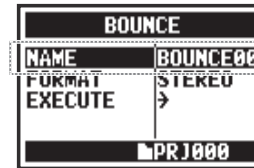

The file will automatically be given a name in "BOUNCEXX" format.



3 Change the name of the file.

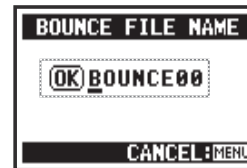

Ref. FILE RENAME P.109

Select output file format: mono or stereo



4 Select FORMAT and press.

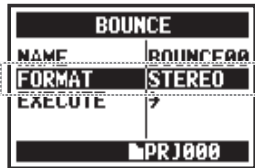

5 Select the file type and press.

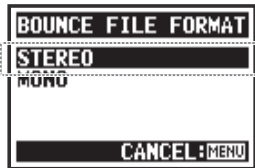

STEREO	Stereo file
MONO	Mono file

Execution



6 Select EXECUTE and press.

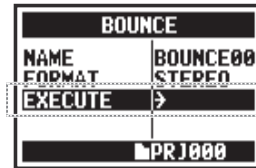

HINT:

“Bouncing” means to combine various music data from different tracks and files into a stereo or mono file.

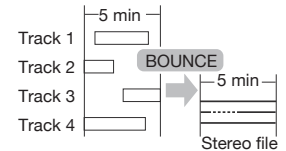

Bouncing creates a new file in the same project.

NOTE:

You cannot use this function during recording or playback.

5-20 Editing/Output: PROJECT PROTECT

Using the PROTECT function on a project prevents the dividing of tracks and changing files in the project.

Select a project and start operation . . . P.119



Press the MENU button for more than 2 seconds, and start operation from the top screen.

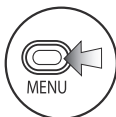

1 Press.



2 Select PROJECT and press.

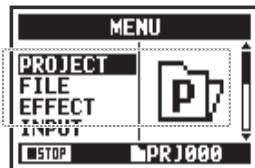

3 Select PROJECT PROTECT and press.



4 Select ON and press.

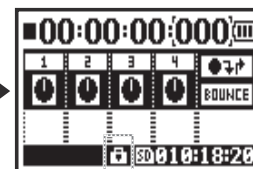
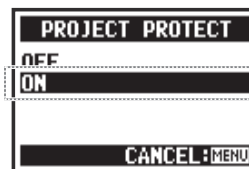

The mark shows the project is protected.

HINT:

If you try to change a file assigned in a track, "Project Protected" will appear on the display.



HINT:

PROTECT is useful to prevent completed music from being accidentally changed.

6-01 Utilities: DISPLAY BACK LIGHT



You can set the time that the display backlight stays lit.

Press the MENU button for more than 2 seconds, and start operation from the top screen.

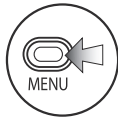

1 Press.



2 Select SYSTEM and press.

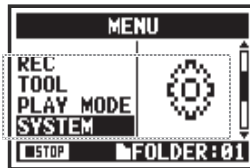

3 Select LIGHT and press.



4 Select the desired time and press.



OFF	The backlight stays off all the time.
ON	The backlight stays on all the time.
15sec (default)	The backlight stays on for 15 seconds after the last key operation.
30sec	The backlight stays on for 30 seconds after the last key operation.

NOTE:

You cannot change this setting during recording or playback.

6-02 Utilities: MEMORY REC

Even without an SD card, the built-in memory can record up to 35 seconds. This is useful for voice memos, for example.

Change the recording mode



When no SD card is loaded, press the MENU button for at least 2 seconds and start from the top screen.

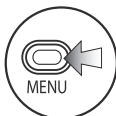

1 Press.



2 Select TOOL and press.

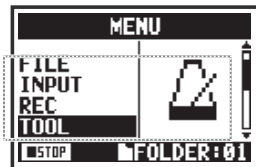

3 Select MEMORY REC and press.

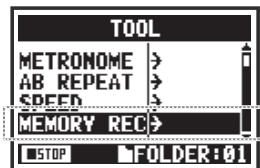

4 Select REC&PLAY.

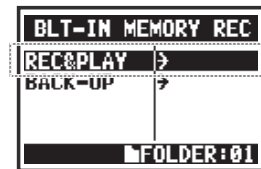

Switch to MEMORY REC mode

Recording and playback

 Record P.047
 Playback P.094

NOTE:

Only one file can be recorded and the maximum time is 35 seconds. Each time you record will erase the previous contents. Please be aware of these restrictions.

Transferring recordings to SD cards



After loading an SD, press the MENU button for at least 2 seconds and start from the top screen.

Open BLT-IN MEMORY REC screen ... P.127



- 1 Select **BACKUP** and press.

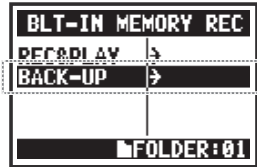

- 2 Select **NAME** to change the file name, or select **FOLDER** to change the destination folder.

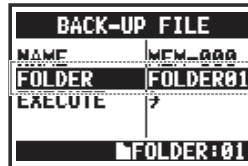
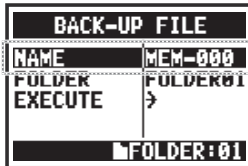
**HINT:**

The destination folder is a stereo mode folder.

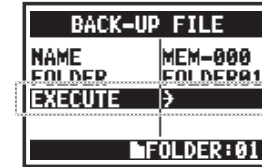

- 3 Select **EXECUTE** and press.

**NOTE:**

If a file with the same name already exists in the destination folder, a screen where you can select **RENAME** or **CANCEL** appears.

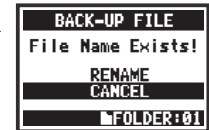

- 4 When the confirmation screen opens, select **YES** and press.

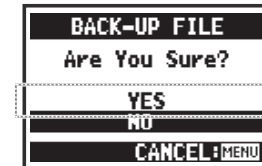

This transfers the file to the SD card and deletes it from the built-in memory.

6-03 Utilities: DISPLAY CONTRAST



Follow these steps to adjust the display contrast.

STEREO **4 CH** **MTR** **STAMINA** Press the MENU button for more than 2 seconds, and start operation from the top screen.

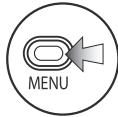

1 Press.



2 Select SYSTEM and press.

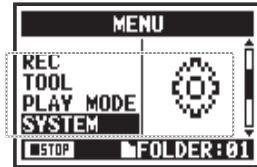

3 Select CONTRAST and press.

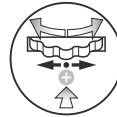

4 Change the number and press.



This can be set from 1 to 8. The higher the number, the greater the contrast (default: 5).

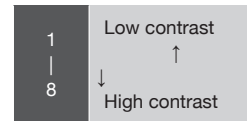

NOTE:

You cannot change this setting during recording and playback.

6-04 Utilities: BATTERY TYPE



By setting the battery type, the H4n Pro can accurately display the remaining battery life.

Press the MENU button for more than 2 seconds, and start operation from the top screen.

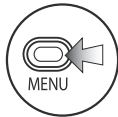

1 Press.



2 Select SYSTEM and press.

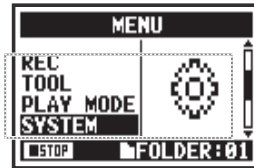

3 Select BATTERY and press.



4 Select the battery type and press.

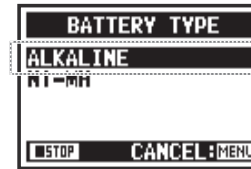

ALKALINE	Alkaline batteries (default)
Ni-MH	Nickel metal hydride rechargeable batteries

NOTE:

Batteries that can be used

- Use alkaline batteries or NiMH rechargeable batteries.
- You cannot change this setting during recording and playback.

6-05 Utilities: VERSION



After startup, you can check the H4n Pro version.

STEREO 4 CH MTR STAMINA Press the MENU button for more than 2 seconds, and start operation from the top screen.

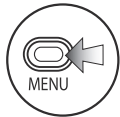

1 Press.



2 Select SYSTEM and press.

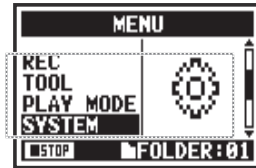

3 Select VERSION and press.



System version

Boot program version

NOTE:

You cannot use this during recording and playback.

6-06 Utilities: FACTORY RESET



This function restores all settings to their original defaults.

Press the MENU button for more than 2 seconds, and start operation from the top screen.

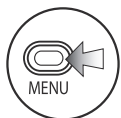

1 Press.



2 Select SYSTEM and press.

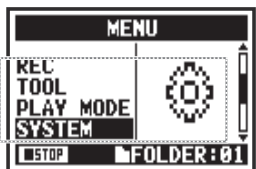

3 Select FAC RESET and press.

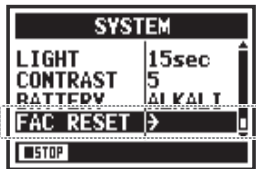

4 Select YES and press.



NOTE:

- You cannot use this function during recording and playback.
- Warning: if you use the FACTORY RESET function, all the settings stored in this unit will be deleted. The settings will be restored to their original defaults.

6-07 Utilities: REMAIN



Do this to confirm the remaining capacity of the SD CARD.

STEREO **4 CH** **MTR** **STAMINA** Press the MENU button for more than 2 seconds, and start operation from the top screen.

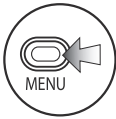

1 Press.



2 Select SD CARD and press.

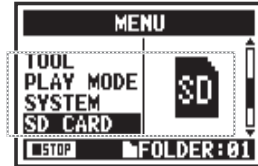

3 Select REMAIN and press.

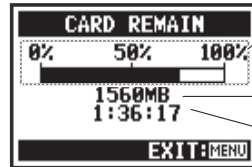
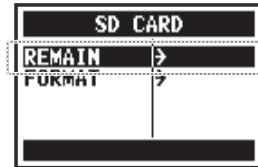

Remaining capacity meter

Remaining space (MB)

Remaining recording time with the current recording format.

NOTE:

You cannot use this during recording and playback.

6-08 Utilities: FORMAT



Use this function to format SD cards for the H4n Pro.

Press the MENU button for more than 2 seconds, and start operation from the top screen.

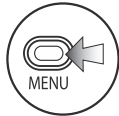

1 Press.



2 Select SD CARD and press.

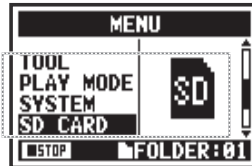

3 Select FORMAT and press.

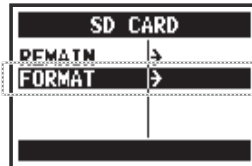

4 Select YES and press.



HINT:

“Format Card?”

“Format Card?” appears during startup if the loaded SD card is not formatted for the H4n Pro.

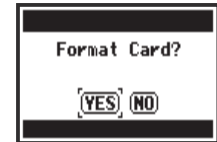

NOTE:

- You cannot use this function during recording and playback.
- Warning: All data will be deleted when you format the SD card.
- SD cards used in a computer or a digital camera should be formatted by the H4n Pro before use with it.

Ref. Using H2 and H4 SD cards P.136

6-09 Utilities: VERSION UP

If the H4n Pro (with an SD card) is connected to a computer (PC) that has access to the internet, you can download H4n Pro software upgrades.

Operations / Utilities: VERSION UP

1 PC

Open the ZOOM website on a computer and download the most recent system software. (zoomcorp.com)

You can check the H4n Pro version on the SYSTEM (SOFTWARE) VERSION screen.



Main system version

2 PC - H4n Pro

Connect the H4n Pro and computer with a USB cable.

Use a USB cable to connect the H4n Pro and a computer.

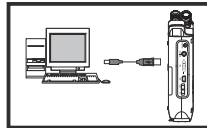

Connect the H4n Pro to a computer with a USB cable.

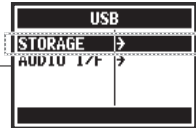

Select STORAGE and press.



You can work with data on the SD card in the H4n Pro from the computer.

3

Copy the downloaded system software to the root directory of the SD card in the H4n Pro.

4 PC - H4n Pro

Disconnect the PC and H4n Pro.

5

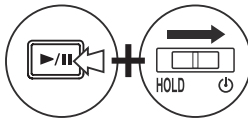

Turn on while holding down the PLAY/PAUSE button.



Select OK and press.



HINT:

Connect to a computer and select STORAGE. The H4n Pro will be recognized as an SD card reader and can be used as one.

NOTE:

Follow the computer procedures to disconnect from it.

Ref. SYSTEM (VERSION)

P.131

6-10 Utilities: Using H2 and H4 SD cards

If you load SD cards from H2 and H4 recorders in the H4n Pro, you can move their files and projects to the H4n Pro.



1 Insert an H2/H4 SD card into the H4n Pro and turn it on.



2 Select YES to move the files.



"H4" if from an H4.



Startup continues

NOTE:

- H2/H4 stereo files and H4 projects will be moved to H4n Pro stereo folders and MTR projects.
- After moving files to the H4n Pro folder, those SD cards will not be recognized in the H2/H4 again.
- The projects are move in order from the lowest numbered to the highest numbered.
- If the H4n Pro has more than 1000 projects in the unit after transfer, "Project Full!" appears and transfer stops.
- You must reduce the number of projects on the H4n Pro to continue transfer.



HINT:

"File Name Exists!"

If a file with the same name already exists in the destination folder, select RENAME and change the name.

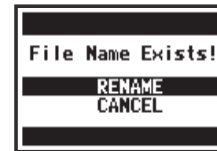

Ref. FILE RENAME P.109

Reference

Main specifications by mode

■ Main specifications by mode

	STEREO	4CH	MTR	STAMINA
Recording formats	Stereo WAV: 44.1/48/96kHz, 16/24-bit Stereo MP3: 48, 56, 64, 80, 96, 112, 128, 160, 192, 224, 256 and 320 kbps, VBR 44.1kHz	Stereo WAV × 2: 44.1/48kHz, 16/24-bit	44.1kHz/16-bit stereo and mono WAV (4 tracks total)	44.1kHz/16-bit WAV (fixed)
Maximum simultaneous recording tracks	2 (one stereo track)	4 (two stereo tracks)	2 (one stereo or two mono tracks)	2 (one stereo track)
File capacity limit	2 GB (If a recording exceeds 2 GB, a new file will be created when recording in STEREO and 4CH modes.)			
File creation during recording	Always save new files (overwrite recording not possible)	Always save new files (overwrite recording not possible)	Select either to overwrite recordings or save new files	Always save new files (overwrite recording not possible)
File saving locations	Save in 10 dedicated folders for STEREO mode	Save in 10 dedicated folders for 4CH mode	Manage multiple files together as projects	Save in 10 dedicated folders for STEREO mode
Changing file names	Possible	Not possible	Possible	Possible
Changing folder names	Not possible	Not possible	Not possible	Not possible
Mark functions	Possible (WAV files only)	Possible (WAV files only)	Not possible	Possible (WAV files only)

Settings available in each mode

■ Menu items

SYSTEM	STEREO	4CH	MTR	STAMINA
DATE/TIME	Δ	Δ	Δ	Δ
LIGHT	○	○	○	○
LCD CONTRAST	○	○	○	○
BATTERY TYPE	○	○	○	○
FACTORY RESET	Δ	Δ	Δ	Δ
SD CARD	STEREO	4CH	MTR	STAMINA
FORMAT	Δ	Δ	Δ	Δ
REMAIN	Δ	Δ	Δ	Δ
USB	STEREO	4CH	MTR	STAMINA
AUDIO IF	Δ	Δ	Δ	—
STORAGE	Δ	Δ	Δ	—
MODE	STEREO	4CH	MTR	STAMINA
MODE	Δ	Δ	Δ	—
FOLDER SELECT	STEREO	4CH	MTR	STAMINA
FOLDER SELECT	Δ	Δ	—	Δ
FILE	STEREO	4CH	MTR	STAMINA
FILE INFORMATION	Δ	Δ	Δ	Δ
FILE RENAME	Δ	Δ	Δ	Δ
FILE MP3 ENCODE	Δ	—	—	—
NORMALIZE	Δ	Δ	—	—
DIVIDE	Δ	—	—	—
MOVE	Δ	Δ	Δ	—
MARK LIST	Δ	Δ	—	Δ
FILE DELETE	Δ	Δ	Δ	Δ
FILE DELETE ALL	Δ	Δ	Δ	Δ
FILE STEREO ENCODE	—	Δ	—	—
FILE COPY	—	—	Δ	—

INPUT SETTING	STEREO	4CH	MTR	STAMINA
LO CUT	○	○	—	○
COMP/LIMIT	○	○	—	—
MONITOR	○	○	○	○
REC LEVEL AUTO	Δ	Δ	—	Δ
MONO MIX	Δ	—	—	Δ
MS STEREO MATRIX	○	○	—	—
PHANTOM	○	○	○	○
PLUG-IN POWER	○	○	○	○
REC SETTING	STEREO	4CH	MTR	STAMINA
REC FORMAT	Δ	Δ	—	—
AUTO REC	Δ	Δ	—	Δ
PRE REC	Δ	Δ	—	—
FILE NAME	Δ	—	—	Δ
TOOL	STEREO	4CH	MTR	STAMINA
TUNER	Δ	Δ	Δ	—
METRONOME*	○	○	○	—
A-B REPEAT	Δ	Δ	—	—
SPEED	Δ	—	—	—
PLAY MODE	STEREO	4CH	MTR	STAMINA
PLAY MODE	Δ	Δ	—	Δ
REC MODE	STEREO	4CH	MTR	STAMINA
REC MODE	—	—	Δ	—
EFFECT	STEREO	4CH	MTR	STAMINA
EDIT	—	—	○	—
IMPORT	—	—	Δ	—

PROJECT	STEREO	4CH	MTR	STAMINA
NEW PROJECT	—	—	Δ	—
SELECT	—	—	Δ	—
RENAME	—	—	Δ	—
COPY	—	—	Δ	—
DELETE	—	—	Δ	—
PUNCH IN/OUT	STEREO	4CH	MTR	STAMINA
PUNCH IN/OUT	—	—	○*	—
BOUNCE	STEREO	4CH	MTR	STAMINA
BOUNCE	—	—	Δ	—

○ ...This can be set during recording and playback (* indicates some exceptions).
 Δ ...This cannot be set during recording and playback.

MTR mode effect types and parameters

■ PREAMP module

● Guitar preamp effects

FD TWNR	Models the sound of the Fender '65 Twin Reverb.
UK 30A	Models the sound of an early class A British combo amp.
HW 100	Models the sound of the HIWATT CUSTOM 100.
FD TWEED	Models the sound of the Fender '59 Bassman.
BGcrunch	Models the sound of the Mesa Boogie Mark III combo amp.
MScrush	Models the crunch sound of the Marshall JCM800 2203.
MS DRIVE	Models the drive sound of the Marshall JCM800 2203.
XTASY BL	Models the sound of the Bogner Ecstasy Blue channel.
SD+XTASY	Combination of Bogner Ecstasy and SweetDrive.
TS+FDcmb	Combination of Fender Combo amp and Ibanez TS-808.
GD+MSstk	Combination of Marshall JCM800 and GoldDrive.
FZ+MSstk	Combination of Marshall JCM800 and Fuzz.

The 12 effects above have the same parameters.

(1) CABINET	0–2	Adjusts the depth of the speaker cabinet sound.
(2) GAIN	0–100	Adjusts the preamp gain (distortion depth).
(3) BASS	–12→12	Adjusts the low-frequency boost/cut.
(4) MIDDLE	–12→12	Adjusts the middle-frequency boost/cut.
(5) TREBLE	–12→12	Adjusts the high-frequency boost/cut.
(6) LEVEL	1–100	Sets the level of the signal after the PREAMP module.
(7) ZNR (ZOOM Noise Reduction)	OFF, 1–16	Adjusts the sensitivity of ZOOM's original ZNR noise reduction effect.

ACO SIM	Makes electric guitar sound like an acoustic guitar	
(1) TOP	0–10	Adjusts the string sound characteristic of acoustic guitars.
(2) BODY	0–10	Adjusts the body sound characteristic of acoustic guitars.
(3) BASS	–12→12	Adjusts the low-frequency boost/cut.
(4) MIDDLE	–12→12	Adjusts the middle-frequency boost/cut.
(5) TREBLE	–12→12	Adjusts the high-frequency boost/cut.
(6) LEVEL	1–100	Sets the level of the signal after the PREAMP module.
(7) ZNR (ZOOM Noise Reduction)	OFF, 1–16	Adjusts the sensitivity of ZOOM's original ZNR noise reduction effect.

• Manufacturer and product names shown in these tables are the trademarks and registered trademarks of various companies. The names are used only to explain sonic characteristics and do not indicate any affiliation with Zoom Corporation.

● Bass preamp effects

SVT	Models the sound of the Ampeg SVT.
BASSMAN	Models the sound of the Fender Bassman 100.
SMR	Models the sound of the SWR SM-900.
SUP-BASS	Models the sound of the Marshall Super Bass.
SANSAMP	Models the sound of the SansAmp Bass Driver DI.
TUBE PRE	ZOOM original tube preamp sound

The 6 effects above have the same parameters.

(1) CABINET	0–2	Adjusts the depth of the speaker cabinet sound.
(2) GAIN	0–100	Adjusts the preamp gain (distortion depth).
(3) BASS	–12–+12	Adjusts the low-frequency boost/cut.
(4) MIDDLE	–12–+12	Adjusts the middle-frequency boost/cut.
(5) TREBLE	–12–+12	Adjusts the high-frequency boost/cut.
(6) BALANCE	0–100	Adjusts the balance between the signals before and after they pass through the module. The higher the value, the greater the post-module signal amount.
(7) LEVEL	1–100	Sets the level of the signal after the PREAMP module.
(8) ZNR (ZOOM Noise Reduction)	OFF, 1–16	Adjusts the sensitivity of ZOOM's original ZNR noise reduction effect.

· Manufacturer and product names shown in these tables are the trademarks and registered trademarks of various companies. The names are used only to explain sonic characteristics and do not indicate any affiliation with Zoom Corporation.

● Mic preamp effects

VO MPRE	Preamp with characteristics good for vocal recording
AG MPRE	Preamp with characteristics good for acoustic guitar recording
FlatMPRE	Preamp with flat characteristics

The 3 effects above have the same parameters.

(1) COMP	OFF, 1–10	Adjusts the compression of the total signal level by lowering high-level signals and raising low-level signals.
(2) DE-ESSER	OFF, 1–10	Adjusts the amount that sibilant sounds are cut.
(3) LOW CUT	OFF, 1–10	Adjusts the frequency of the filter that cuts low-frequency noise, which is easily picked up by mics.
(4) BASS	–12–+12	Adjusts the low-frequency boost/cut.
(5) MIDDLE	–12–+12	Adjusts the middle-frequency boost/cut.
(6) TREBLE	–12–+12	Adjusts the high-frequency boost/cut.
(7) LEVEL	1–100	Sets the level of the signal after the PREAMP module.
(8) ZNR (ZOOM Noise Reduction)	OFF, 1–16	Adjusts the sensitivity of ZOOM's original ZNR noise reduction effect.



MTR mode effect types and parameters

■ EFX modules

● Compressor/limiter effects

RackComp	Compressors reduce high-level signals and raise the minimum level.	
(1) THRESHOLD	0–50	Sets the base level from which the compressor operates.
(2) RATIO	1–10	Sets the compression ratio.
(3) ATTACK	1–10	Sets how quickly compression starts.
(4) LEVEL	2–100	Sets the level of the signal after the EFX module.
LIMITER	Limiters compress when input signals exceed the fixed level.	
(1) THRESHOLD	0–50	This sets the base level from which the limiter operates.
(2) RATIO	1–10	Sets the compression ratio.
(3) RELEASE	1–10	Sets how quickly the limiter stops functioning after the signal goes below the base level.
(4) LEVEL	2–100	Sets the level of the signal after the EFX module.

● Modulation effects

AUTO WAH	This wah effect responds to changes in input signal strength.	
(1) POSITION	Before, After	Sets the insertion point of the EFX module. Select before or after the PREAMP.
(2) SENSE	–10–1, 1–10	Sets the effect sensitivity.
(3) RESONANC	0–10	Sets the amount of resonance.
(4) LEVEL	2–100	Sets the level of the signal after the EFX module.
PHASER	This effect varies the sound with phasing.	
(1) POSITION	Before, After	Sets the insertion point of the EFX module. Select before or after the PREAMP.
(2) RATE	0–50.  (See P.146)	Adjusts the speed of modulation.
(3) COLOR	4STAGE, 8STAGE, INVERT4, INVERT8	Select the effect sound type.
(4) LEVEL	2–100	Sets the level of the signal after the EFX module.
TREMOLO	This effect raises and lowers the volume cyclically.	
(1) DEPTH	0–50	Adjusts the modulation depth.
(2) RATE	0–50.  (See P.146)	Adjusts the speed of modulation.
(3) WAVE	UP 0–9 DOWN 0–9 TRI 0–9	Select the modulation waveform from UP (rising sawtooth), DOWN (falling sawtooth) and TRI (triangle) types. The higher the number, the more the wave peaks are clipped, emphasizing the effect.
(4) LEVEL	2–100	Sets the level of the signal after the EFX module.

RING MOD	This effect creates a metallic sound. The FREQ setting can drastically change the tone.	
(1) POSITION	Before, After	Sets the insertion point of the EFX module. Select before or after the PREAMP.
(2) FREQ	1–50	Sets the frequency of modulation.
(3) BALANCE	0–100	Adjusts the balance of the original and effect sounds.
(4) LEVEL	2–100	Sets the level of the signal after the EFX module.

SLOW ATK	This effect makes the attack of each note gradual, creating a violin-like sound.	
(1) POSITION	Before, After	Sets the insertion point of the EFX module. Select before or after the PREAMP.
(2) TIME	1–50	Adjusts the attack time.
(3) CURVE	0–10	Sets the volume change curve of the attack.
(4) LEVEL	2–100	Sets the level of the signal after the EFX module.

CHORUS	This mixes an effect sound that varies from the original pitch, creating a varying thick sound.	
ENSEMBLE	This chorus ensemble effect features three-dimensional movement.	

The 2 effects above have the same parameters.

(1) DEPTH	0–100	Adjusts the modulation depth.
(2) RATE	0–50	Adjusts the speed of modulation.
(3) TONE	0–10	Adjusts the tone.
(4) MIX	0–100	Adjusts the amount of effect sound mixed with the original sound.

FLANGER	This effect adds modulation and strong undulations to the sound.	
(1) DEPTH	0–100	Adjusts the modulation depth.
(2) RATE	0–50,  (See P.146)	Adjusts the speed of modulation.
(3) RESONANC	-10→+10	Sets the amount of modulation resonance.
(4) MANUAL	0–100	Adjusts the frequency band affected.

STEP	This special effect changes the tone in steps.	
(1) DEPTH	0–100	Adjusts the modulation depth.
(2) RATE	0–50,  (See P.146)	Adjusts the speed of modulation.
(3) RESONANC	0–10	Sets the amount of modulation resonance.
(4) SHAPE	0–10	Sets the effect sound envelope.

VIBE	This effect automatically adds vibrato.	
(1) DEPTH	0–100	Adjusts the modulation depth.
(2) RATE	0–50,  (See P.146)	Adjusts the speed of modulation.
(3) TONE	0–10	Adjusts the tone.
(4) BALANCE	0–100	Adjusts the balance of the original and effect sounds.

MTR mode effect types and parameters

CRY		This effect varies the sound like a talking modulator.
(1) RANGE	1-10	Adjusts the frequency band affected.
(2) RESONANC	0-10	Sets the amount of resonance.
(3) SENSE	-10-1, 1-10	Sets the effect sensitivity.
(4) BALANCE	0-100	Adjusts the balance of the original and effect sounds.

PITCH		This effect shifts the pitch up or down
(1) SHIFT	-12+12, 24	Sets the pitch shift in semitones.
(2) TONE	0-10	Adjusts the tone.
(3) FINE	-25+25	Adjusts the pitch shift in cents (1/100 semitone).
(4) BALANCE	0-100	Adjusts the balance of the original and effect sounds.

● Delay/reverb effects

AIR		This effect reproduces the reverberant atmosphere of a room and provides spatial depth.
(1) SIZE	1-100	Sets the size of the space.
(2) REFLEX	0-10	Sets the amount of wall reflections.
(3) TONE	0-10	Adjusts the tone.
(4) MIX	0-100	Adjusts the amount of effect sound mixed with the original sound.

DELAY		This delay supports long delay times of up to 5000 ms.
ECHO		This tape echo simulation supports long delay times of up to 5000 ms.
ANALOG		This warm analog delay simulation supports long delay times of up to 5000 ms.

The 3 effects above have the same parameters.

(1) TIME	1-5000 ms.  (See P.146)	Sets the delay time.
(2) FEEDBACK	0-100	Adjusts the amount of feedback.
(3) HIDAMP	0-10	Adjusts the damping of high frequencies in the delay sound.
(4) MIX	0-100	Adjusts the amount of effect sound mixed with the original sound.

RvsDelay	This delay supports long delay times of up to 2500 ms.	
(1) TIME	10–2500 ms,*  (See P.146)	Sets the delay time.
(2) FEEDBACK	0–100	Adjusts the amount of feedback.
(3) HIDAMP	0–10	Adjusts the damping of high frequencies in the delay sound.
(4) MIX	0–100	Adjusts the amount of effect sound mixed with the original sound.

*milliseconds













HALL	This reverb simulates the acoustics of a concert hall.
ROOM	This reverb simulates the acoustics of a room.
SPRING	This is a spring reverb simulation.
ARENA	This simulates the acoustics of an arena-sized venue.
T ROOM	This simulates the acoustics of a tiled room.
M SPRING	This is a spring reverb simulation with a bright and clear tone.

The 6 effects above have the same parameters.

(1) DECAY	1–30	Sets the reverb duration.
(2) PRE DLY	1–100	Sets the time between when the original sound is input and reverb starts.
(3) TONE	0–10	Adjusts the tone.
(4) MIX	0–100	Adjusts the amount of effect sound mixed with the original sound.

Note durations

Parameters with  values allow you to make settings in note units based on the metronome tempo. The lengths of the notes are as follows.

	Thirty-second note	 3	Half note triplet	 x 3	Quarter note x 3
	Sixteenth note		Dotted eighth note	⋮	⋮
 3	Quarter note triplet		Quarter note		
	Dotted sixteenth note		Dotted quarter note		
	Eighth note	 x 2	Quarter note x 2	 x 20	Quarter note x 20

NOTE

- The note values that can be selected depend on the parameter.
- Certain combinations of tempo and note values could exceed parameter ranges. If this occurs, the value will be halved or even quartered to achieve the allowed range.

H4n Pro patch list

The patches in this list can be used in MTR mode and when the H4n Pro is functioning as an audio interface (at 44.1kHz sampling rate).

Category	No.	Patch name	Description	PREAMP module	EFX module
Guitar	00	Tweed Clean	This FD TWEED clean sound goes great with Stratocasters.	FD TWEED	SPRING
	01	Liverpool	A 60s revival sound is created by gently driving a Class A British combo amp.	UK 30A	AIR
	02	Clean Chorus	This clean sound is good for muted rhythmic and arpeggio playing.	FD TWNR	CHORUS
	03	Clean Delay	Using a long delay, this clean sound is good for sustained chords and arpeggios.	FD TWNR	ECHO
	04	Clean Trem	This clean sound varies the volume and can be said to be the original effect.	HW 100	TREMOLO
	05	Aco.Simulate	This acoustic guitar simulation is ideal for stroking.	Aco Sim	AIR
	06	Spy's Shadow	Wrapped in spring reverb, this twangy guitar sound is perfect for electric instruments.	FD TWNR	M SPRING
	07	Wah Cutting	This funky rhythmic tone uses FD TWNR and AUTO WAH.	FD TWNR	AUTO WAH
	08	Glossy Blues	This bewitching Fender '59 BASSMAN crunch sound follows the dynamics of the player.	FD TWEED	ROOM
	09	UK Crunch	A sense of AIR is added to the natural crunch of a Class A British combo amp.	UK 30A	AIR
	10	Box Of Edge	U2's The Edge popularized this distinctive dotted-eighth-note delay effect (at 130 BPM).	UK 30A	ECHO
	11	HW Crunch	Crunch sound of a HIWATT CUSTOM 100.	HW 100	ROOM
	12	Melody	Analog delay adds a natural sense of space to TS+FDcmb for a sound that suits simple melodies.	TS+FDcmb	ANALOG
	13	ZEP Drive	A classic Marshall crunch re-creates the sound of Led Zeppelin.	MScrunch	RackComp
	14	Mellow Vibe	MScrunch and Vibe combine to create a laid-back sound.	MScrunch	VIBE
	15	70's Drive	The sound of 70s rock.	MS DRIVE	ECHO
	16	Boogie Drive	The Mesa Boogie Mark III sound creates a mid-range thickness in this drive that is good for soloing.	BGcrunch	ROOM
	17	MS Drive	For the early sound of Van Halen, the Marshall is turned all the way up.	GD+MSstk	ARENA
	18	XTASY Riff	SD+XTASY makes this great for metal riffs.	SD+XTASY	OFF
	19	Jet MS Drive	Heavy Marshall distortion is combined with a flanger for this epic sound.	GD+MSstk	FLANGER
	20	Talking Guy	This talking sound follows the guitar pickup position and picking dynamics.	GD+MSstk	CRY
	21	Oct Lead	Octave doubling below the original pitch creates a heavy impactful drive sound.	GD+MSstk	PITCH
	22	Dirty Drive	Fuzz gives this classic 70s progressive rock sound its powerful sustain.	FZ+MSstk	ANALOG
	23	Fuzz Lead	Vintage Marshall and fuzz effects combine to re-create the sweet and beautiful fuzz tone used by Eric Johnson.	FZ+MSstk	ARENA
24	XTASY Lead	This metal lead sound uses XTASY BL and ECHO effects.	XTASY BL	ECHO	

Category	No.	Patch name	Description	PREAMP module	EFX module	
Bass	25	SVT	This is the perfect Ampeg SVT rock sound.	SVT	OFF	
	26	SMR	The SWR SM-900 modeling provides a tight sound.	SMR	LIMITER	
	27	BASSMAN	This classic sound uses Fender BASSMAN 100 modeling.	BASSMAN	OFF	
	28	SUP-BASS	The showy drive sound of a Marshall Super Bass.	SUP-BASS	OFF	
	29	SANSAMP	The SansAmp sound plays well with other instruments.	SANSAMP	OFF	
	30	TUBE PRE	A thick TUBE PRE distortion sound.	TUBE PRE	OFF	
	31	Funk Wah	Responding to changes in touch dynamics, this funk wah sound can be used in many situations.	SMR	AUTO WAH	
	32	Slap Comp	Combining RackComp and TUBE PRE, this clean sound is perfect for slapping and tapping.	TUBE PRE	RackComp	
	33	Bass Phaser	This go-to phaser sound combines PHASER and TUBE PRE effects.	TUBE PRE	PHASER	
	34	Fuzz Room	The combination of SUP-BASS and ROOM effects make this fuzz sound for soloing.	SUP-BASS	ROOM	
	Mic	35	StandardComp	Standard compressor optimized for recording.	FlatMPRE	RackComp
		36	Studio Comp	Compressor suitable for vocal recording.	VO MPRE	RackComp
		37	Chorus Vocal	Deep chorus sound for solo vocals.	VO MPRE	CHORUS
		38	Flange Vocal	Flanger sound for soothing pop vocals.	VO MPRE	FLANGER
39		Light Vocal	Perfect when seeking bright and articulate vocals.	FlatMPRE	ROOM	
40		Spring	Sound made distinctive with the effect of spring reverb.	VO MPRE	SPRING	
41		Arena	Deep reverb sounds like singing in an arena.	VO MPRE	ARENA	
42		Doubling	Conventional doubling effect.	VO MPRE	DELAY	
43		Lead Vocal	Delay suitable for main vocal parts.	VO MPRE	DELAY	
44		Analog Echo	Analog style echo sound for vocals using an analog delay model.	VO MPRE	ANALOG	
45		Reverse Trip	Trippy sound using a reverse delay.	VO MPRE	RvsDelay	
46		AG Reverb	Preamp and reverb combination optimized for mic recording of acoustic guitars.	AG MPRE	ARENA	
47		AG Arpeggio	Preamp and chorus combination optimized for mic recording of acoustic guitar (playing arpeggios).	AG MPRE	CHORUS	
48		AG Ensemble	Preamp and ensemble combination optimized for mic recording of acoustic guitar (playing arpeggios).	AG MPRE	ENSEMBLE	
49		AG Lead	Preamp and delay combination optimized for mic recording of acoustic guitars (playing lead).	AG MPRE	DELAY	
50–59	EMPTY					

Note: Company and product names in this patch list are trade names and trademarks of their respective owners and do not indicate any affiliation with Zoom Corporation.
All product names and explanations identify products that were used for reference in the development of this product.

H4n Pro specifications

Recorder		STEREO mode	4CH mode	MTR mode
	Simultaneous recording tracks	2	4	2
	Simultaneous playback tracks	2	4	4
	Recording time	4GB (SDHC) About 380 minutes (44.1kHz/16-bit stereo WAV tracks) About 68 hours (44.1kHz/128kbps Stereo MP3 tracks) Note: These recording times are approximations. Actual times might be slightly shorter according to recording conditions.		
	Maximum recording file size	2 GB		
	Projects	1000/card		
	Counter	Hour: minute: second: millisecond		
	Other functions	Punch-in/out, bounce, A-B repeat		
Effects	Modules	2		
		Stereo/4CH mode: LO CUT, COMP/LIMITER MTR mode: PRE AMP module, EFX module		
	Types	53		
	Patches	60		
	Tuners	Chromatic, Guitar, Bass, Open A/D/E/G		
Metronome	Sounds	5		
	Rhythmic patterns	Unaccented, 1/4–8/4, 6/8		
	Tempo range	40.0–250.0 BPM		
A/D conversion	24-bit	128x oversampling		
D/A conversion	24-bit	128x oversampling		
Recording media	SD cards (16MB – 2GB), SDHC cards (4GB – 32GB)			
Data types	WAV format			
	Recording/playback	Quantization: 16/24-bit Sampling frequencies: 44.1/48/96 kHz		
	MP3 format			
	Recording	Bit rates: 48, 56, 64, 80, 96, 112, 128, 160, 192, 224, 256, 320 kbps, VBR Sampling frequency: 44.1 kHz		
	Playback	Bit rates: 32, 40, 48, 56, 64, 80, 96, 112, 128, 160, 192, 224, 256, 320 kbps, VBR Sampling frequencies: 44.1/48 kHz		
Display	128x64 dot matrix	Full-dot LCD (with backlight)		

Inputs	Built-in mics	Directionality	Unidirectional
		Sensitivity	–45dB/1Pa at 1kHz
		Input gain	–16 dB – +51 dB
		Maximum sound pressure input	140 dBspl
	EXT MIC	Input gain	–16 dB – +51 dB
		Input impedance	2 kΩ or more
		Supports plug-in power	
	INPUT 1 and 2 balanced input	Connector	XLR (pin 2 hot)
		Input gain	–16 dB – +43 dB
		Input impedance	3.0 kΩ or more
Maximum permissible input level		–6 dBu	
EIN		–120 dBu or less	
INPUT 1 and 2 unbalanced input	Connector	Standard phone	
	Input gain	–30 dB – +32 dB	
	Input impedance	470 kΩ or more	
	Maximum permissible input level	+2 dBu	
Outputs	LINE/PHONE stereo mini jack	LINE output load impedance	10 kΩ or more
		LINE rated output level	–10 dBu
		PHONE 17 mW + 17 mW (into 32Ω load)	
	Built-in speaker	400mW 8Ω mono speaker	
Phantom power	48 V, 24 V, OFF		
USB	USB 2.0 High Speed		
	Operation as mass storage or audio interface USB functions can be powered using USB bus power		
Power	DC 5V 1A AC adapter (ZOOM AD-14), 2 AA batteries		
Continuous recording time	STEREO mode Using built-in mics at 44.1kHz/16-bit without headphones connected About 5.5 hours using alkaline batteries or about 7.5 hours using NiMH (2500mAh) batteries		
	STAMINA mode Using built-in mics at 44.1kHz/16-bit without headphones connected About 8 hours using alkaline batteries or about 10.5 hours using NiMH (2500mAh) batteries		
External dimensions	73 (W) × 157.2 (D) × 37 (H) mm		
Weight	294 g		

Notes: 0 dBm = 0.755 Vrms

For the purpose of improvement, product specifications and appearance are subject to change without notice.

Troubleshooting

If you think that the H4n Pro is operating strangely, check the following items first.

Recording/playback trouble

◆ There is no sound or output is very quiet

- Check the connections to your monitoring system and its volume setting.
- Confirm that the volume levels of tracks 1–4 are not too low.

◆ Recorder stops during playback

- If playback is started when a track is in recording standby, a temporary file is created on the H4n Pro. If the remaining capacity of the SD card is low, the temporary file may use all the remaining space, causing playback to stop. In this case, end recording standby of the track.

◆ Sound from connected instruments cannot be heard or is very quiet

- Check the input source settings. (→ P045)
- Confirm that the recording level settings are suitable. (→ P045)
- If INPUT 1 or 2 jacks are used, raise the output level of the connected device.
- When the monitor function (→ P070) is off, an input signal can only be monitored if its track is set to recording standby or if the recorder is in recording standby.

◆ Cannot record on a track

- Confirm that the REC button and that TRACK button are lit red.
- If a project is protected, recording is not possible. Use another project or turn protection off. (→ P125)

- Confirm that an SD card is loaded in the slot.
- Confirm that the hold function is not activated. (→ P018)
- If “Card Protected!” appears on the display, the SD card write-protection is enabled. Slide the write-protection switch on the SD card to disable write-protection.

◆ Cannot bounce

- Confirm that the volume levels of tracks 1–4 are not too low.
- Confirm that the SD card has enough open space.

Other trouble

◆ Cannot use effects

- Confirm that the effects are on. Effects are off in MTR mode by default.

◆ Cannot use tuner

- Confirm that the jack to which the instrument is connected is selected as the input source.

◆ Computer does not recognize it even though it is connected to a USB port

- Confirm that the operating system is compatible. (→ P033)
- The operation mode must be set on the H4n Pro to allow the computer to recognize it. (→ P031)

Index

4CH MODE

- Details ▶**35-37**
- Mode and top screen ▶**P39**
- Mode selection ▶**P36**
- Playback operation ▶**P94**
- Recording operation ▶**P51**

A

- AB repeat ▶**P97**
- Always New recording mode ▶**P56**
- AUDIO I/F (Audio interface), use as ▶**P31**
- AUTO PUNCH IN/OUT ▶**P59**
- AUTO REC ▶**P63**
- AUTO REC STOP ▶**P64**

B

- Battery/Power outlet setting ▶**P15**
- BATTERY TYPE ▶**P130**
- Bit rate ▶**P49**
- BOUNCE ▶**P123**
- Built-in microphones ▶**P28**
- Built-in speaker ▶**P34**

C

- Copyright warnings▶**P7**
- CANCEL operation ▶**P23**
- CARIB/TUNER ▶**P77**
- CHROMATIC/TUNER ▶**P75**
- COMP/LIMIT ▶**P67**
- Connections ▶**P30**

D

- DATE/TIME ▶**P26**
- DAW software ▶**P32**
- DIVIDE ▶**P116**
- DIAL use as ▶**P23**
- DISPLAY**
 - DISPLAY BACK LIGHT ▶**P126**
 - DISPLAY CONTRAST ▶**P129**

E

- EFFECT ▶P81–**
 - EDIT ▶**P84**
 - EDIT (EFX) ▶**P86**
 - EDIT (LEVEL) ▶**P87**
 - EDIT (PRE AMP) ▶**P85**

- EDIT (RENAME) ▶**P87**
- EDIT (STORE) ▶**P88**
- Effect types and parameters ▶**P141**
- Effects ▶**P81**
- IMPORT ▶**P89**
- Patch List ▶**P147**
- EFX module/EFFECT ▶**P86**

F

- FACTORY RESET ▶**P132**
- FILE**
 - FILE (COPY) ▶**P108**
 - FILE DELETE ▶**P106**
 - FILE DELETE ALL ▶**P107**
 - FILE INFORMATION ▶**P105**
 - FILE MP3 ENCODE ▶**P111**
 - FILE NAME ▶**P50**
 - FILE NORMALIZE ▶**P112**
 - FILE RENAME ▶**P109**
 - FILE SELECT ▶**P104**
 - FILE STEREO ENCODE ▶**P113**
 - FILE/TRACK MENU ▶**P57**
- FOLDER SELECT ▶**P103**
- FORMAT ▶**P134**

- H**
HOLD switch ▶P17
- I**
IMPORT/EFFECT ▶P89
INPUT MIC12 buttons operations ▶P21
INPUT/TUNER ▶P78
- K**
KARAOKE
Preparation ▶P91
Recording ▶P93
Setting/TRACK MENU ▶P57
- L**
LEVEL/EFFECT ▶P87
LEVEL/TRACK MENU ▶P57
Locator buttons operations ▶P19
LO CUT ▶P66
- M**
Manual PUNCH IN/OUT ▶P61
MARK ▶P96
MARK LIST ▶P115
MENU
MAIN MENU ▶P41
MENU button operations ▶P23
METRONOME ▶P79
MIXER ▶P100
Mixing ▶P57
MODE ▶P35–42
MONITOR ▶P70
MONO MIX ▶P72
MOVE ▶P117
MP3 ENCODE ▶P111
MP3 file format ▶P49
MS STEREO MATRIX ▶P73
MTR MODE
Always new recording mode ▶P56
Mode and top screen ▶P40
Mode selection ▶P36
Over write recording mode ▶P55
Playback operations ▶P101
Recording operations ▶P53
TRACK MENU ▶P57
- N**
NEW PROJECT ▶P118
NORMALIZE ▶P112
- O**
Off-mic recording ▶P29
On-mic recording ▶P29
Over write recording mode ▶P55
- P**
PATCH EDIT/EFFECT ▶P84
Patch List ▶P147
PAN/TRACK MENU ▶P57
Phantom power ▶P30
PLAY MODE ▶P95
Plug-in power ▶P29
POWER switch ▶P17
Power On and Off ▶P17
PRE AMP/EFFECT ▶P85
PRE REC ▶P65
PROJECT
BOUNCE ▶P123
COPY ▶P122
DELETE ▶P120

Index

NEW PROJECT ▶P118
RENAME ▶P121
PROTECT ▶P125
SELECT ▶P119
PUNCH IN/OUT (Auto) ▶P59
PUNCH IN/OUT (Manual) ▶P61

R

REC FORMAT ▶P49
REC LEVEL AUTO ▶P69
REC LEVEL operations ▶P22
REC button operations ▶P19
Recording (stereo/stamina mode) ▶P47
Recording (4CH mode) ▶P51
Recording (MTR mode) ▶P53
Recording track selection ▶P45
REMAIN ▶P133
Remote control (option) ▶P43
RENAME/EFFECT ▶P87
RENAME/FILE ▶P109
RENAME/PROJECT ▶P121

S

Safety precautions for users ▶P6
Setting ▶P27
SD CARD
Audio Interface, use as ▶P31
H2, H4 SD card, use as ▶P136
Checking available space on the SD card ▶P133
SD card reader, use as ▶P33
Software version upgrading ▶P135
SPEED ▶P99
STAMINA MODE
Details ▶P37,38
Mode and top screen ▶P38
Mode setting ▶P15-36
Playback operation ▶P94
Recording operation ▶P47
STEREO ENCODE ▶P113
STEREO MODE
Details ▶P37-38
Mode and top screen ▶P38
Mode selection ▶P36
Playback operation ▶P94
Recording operation ▶P47
STEREO LINK ▶P58
STORAGE ▶P33-133
STORE/EFFECT ▶P88

T

TRACK MENU ▶P57
TRACK 1234 buttons operations ▶P20
TUNER
CARIB ▶P77
CHROMATIC ▶P75
GUITAR, OPEN G, DAGDAG ▶P78
INPUT ▶P78
TUNER types ▶P78

U

USB connection
H4n Pro used as a SD card reader ▶P33
H4n Pro used as an Audio Interface ▶P31
USB bus power ▶P31

V

VOLUME operations ▶P22
WAV file format ▶P49
Write-protect ▶P125

The FCC regulation warning (for U.S.A.)

This equipment has been tested and found to comply with the limits for a Class B digital device, pursuant to Part 15 of the FCC Rules. These limits are designed to provide reasonable protection against harmful interference in a residential installation. This equipment generates, uses, and can radiate radio frequency energy and, if not installed and used in accordance with the instructions, may cause

harmful interference to radio communications. However, there is no guarantee that interference will not occur in a particular installation. If this equipment does cause harmful interference to radio or television reception, which can be determined by turning the equipment off and on, the user is encouraged to try to correct the interference by one or more of the following measures:

- **Reorient or relocate the receiving antenna.**
- **Increase the separation between the equipment and receiver.**
- **Connect the equipment into an outlet on a circuit different from that to which the receiver is connected.**
- **Consult the dealer or an experienced radio/TV technician for help.**

For EU Countries



Declaration of Conformity



ZOOM CORPORATION

4-4-3 Kanda-surugadai,
Chiyoda-ku, Tokyo 101-0062 Japan
zoomcorp.com