

# H6studio Firmware Update Guide

Copyright(C) 2026 ZOOM CORPORATION. All Rights Reserved.

Proper display is not possible on grayscale devices.

## Introduction

### ■Items to prepare

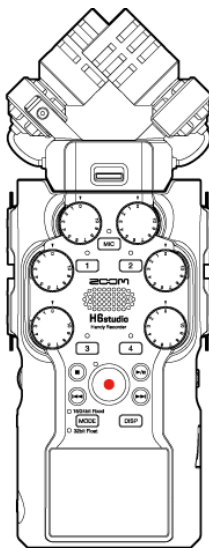

H6studio



Windows or macOS computer  
with Internet access

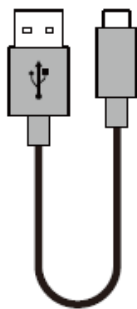

USB Type-C cable



microSD card

Supported recording media  
microSDHC: 4 GB – 32 GB  
microSDXC: 64 GB – 1 TB

Always format microSD cards on the H6studio after purchasing them new or using them with a different device.

### ■Firmware update process

1. Download the firmware update file.
2. Extract the ZIP file.
3. Copy the extracted firmware update file to a microSD card.
4. Update the firmware.
5. Confirm that the firmware has been updated correctly.

# Updating the Firmware

This guide explains firmware update to version 1.50 as an example.

## 1. Download the firmware update file.

Download the ZIP file that contains the firmware update file from the H6studio download page.

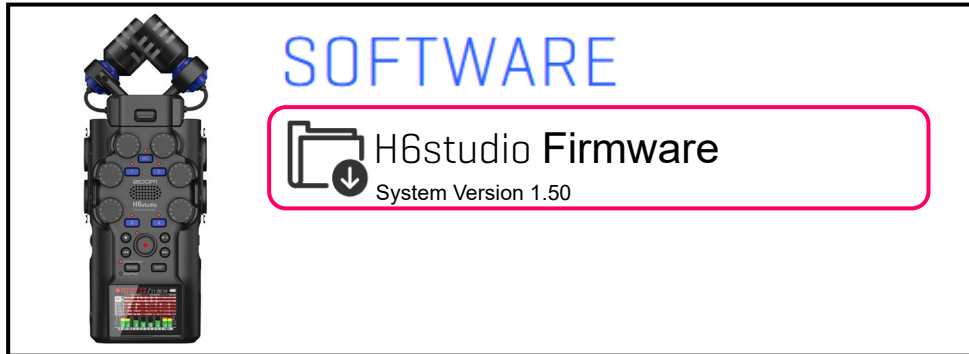

## On Windows

### 2. Extract the ZIP file

Select the folder that contains the downloaded ZIP file. Click ①“Compressed Folder Tools” and then click ②“Extract all”. This extracts the ZIP file.

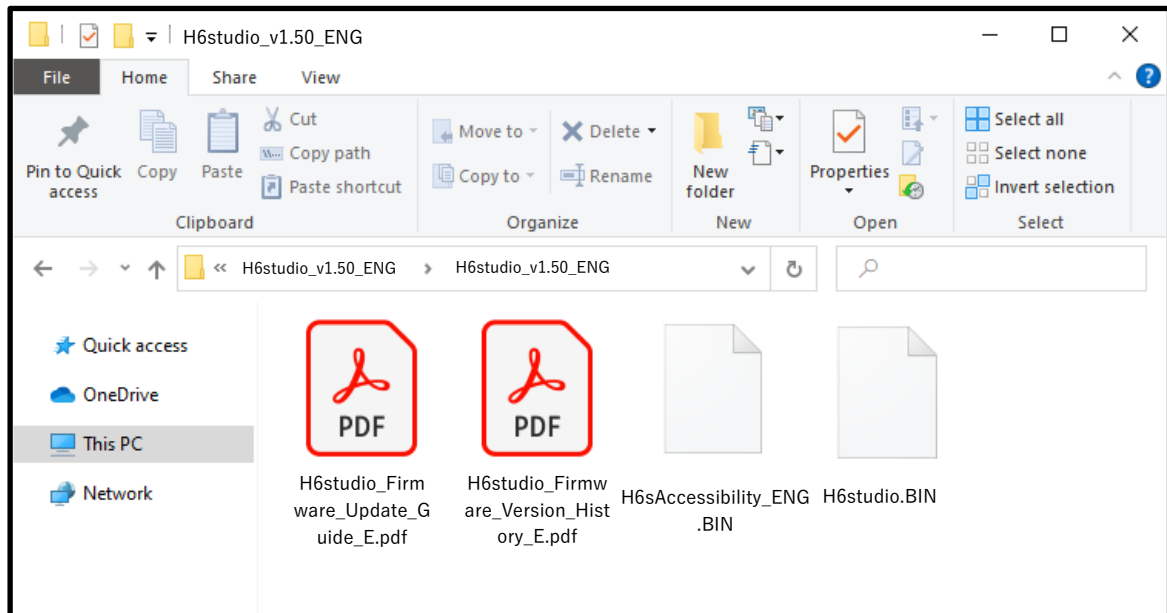
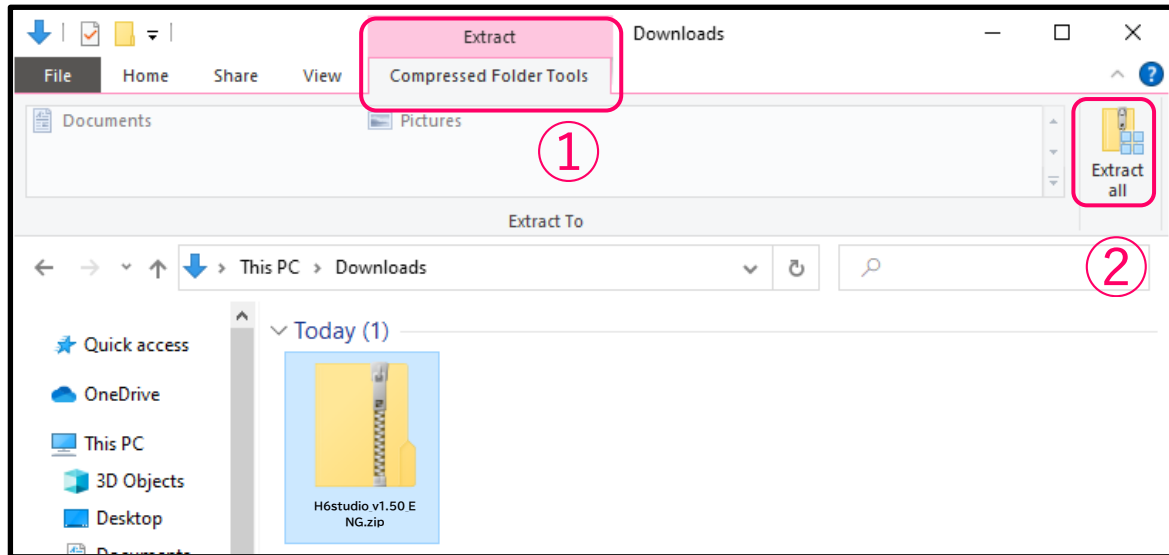

3. Copy the firmware update files to a microSD card.

Copy the “H6studio.BIN” and “H6sAccessibility\_XXX.BIN” (XXX is the language) files to a microSD card.

microSD

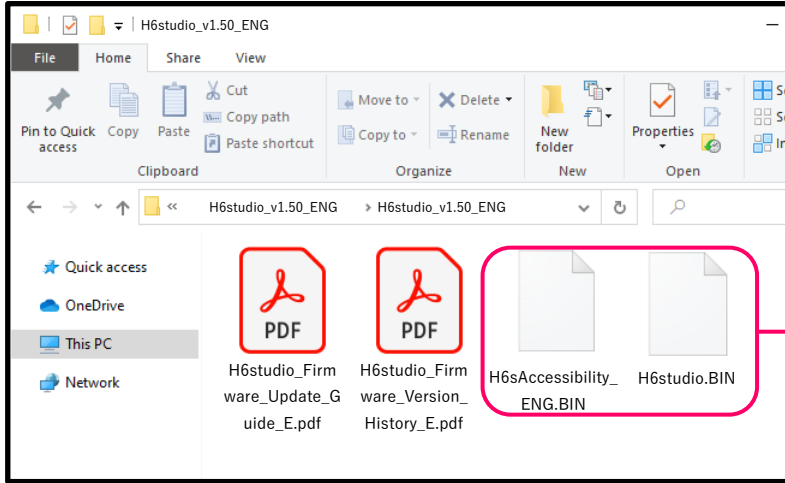

Firmware update files

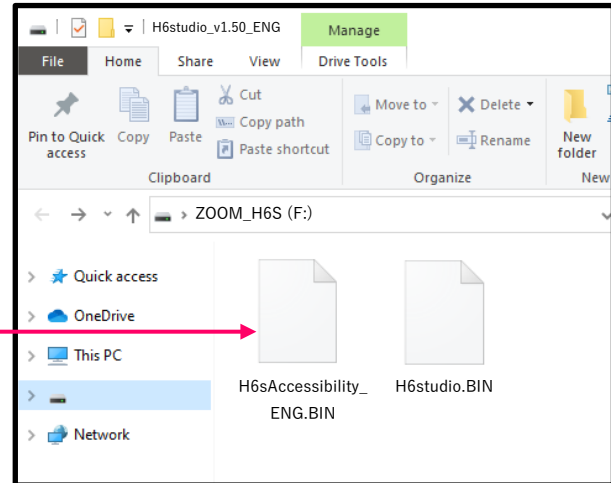

Copy the 2 firmware update files to a microSD card

## On macOS

### 2. Extract the ZIP file.

After downloading, open the ①“Downloads” folder which appears at the right end of the Dock by default. Then, click ②. Downloaded files will be shown.



### 3. Copy the firmware update files to a microSD card.

Copy the “H6studio.BIN” and “H6sAccessibility\_XXX.BIN” (XXX is the language) files to a microSD card.

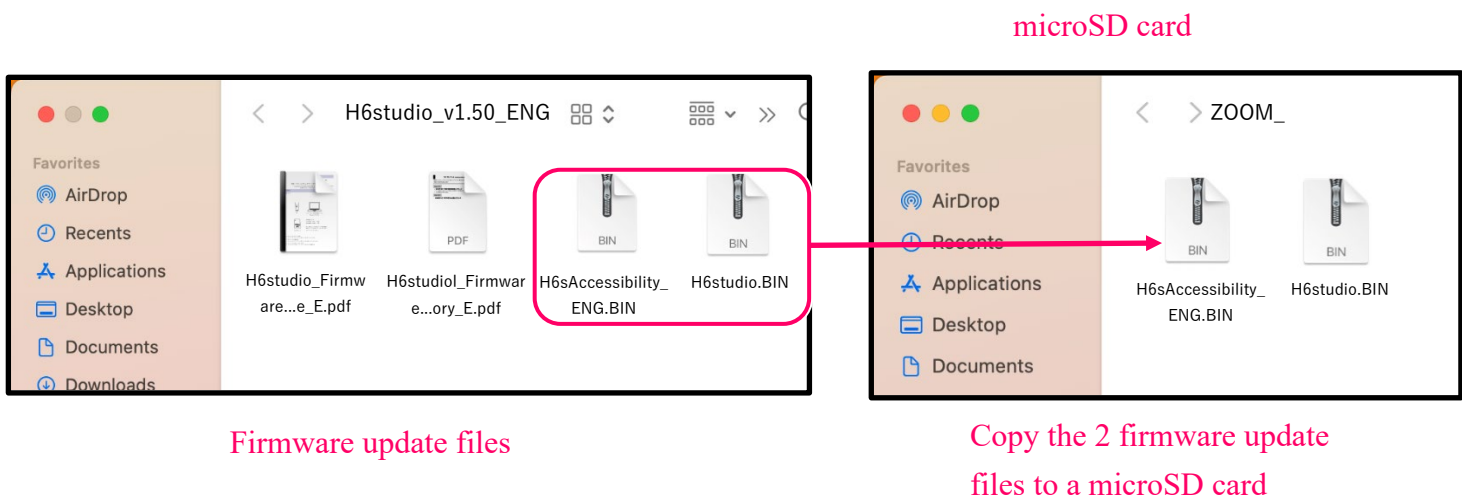

## The following procedures are the same on both Windows and macOS.

4. Connect the power source (AC adapter, USB bus power or portable battery) to the USB port (Type-C) of H6studio.

### NOTE

- When performing a firmware update using batteries, the update may not be possible depending on the remaining battery charge.

5. Insert the microSD card into the H6studio.

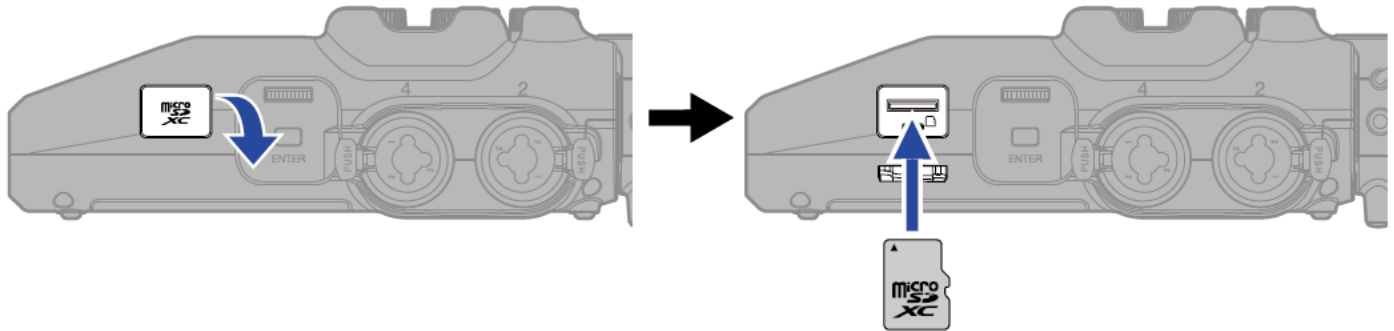

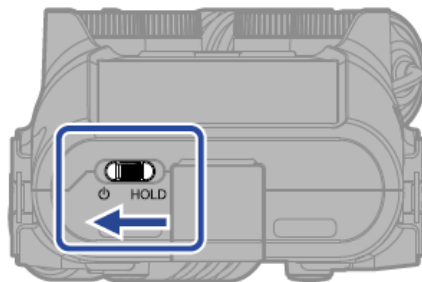

6. Slide  toward  .

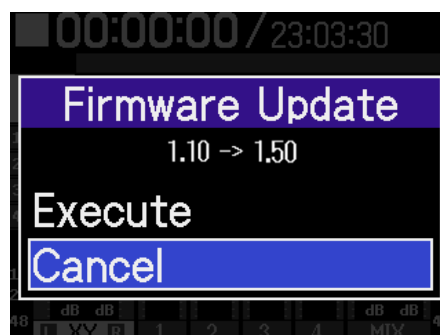

This opens the firmware update confirmation screen.



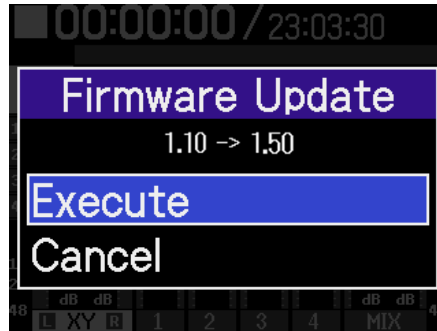

7. Use  to select “Execute” and press  .





### HINT

Even if “Cancel” is selected, the firmware can still be updated from the System Settings Screen .

(→ [Updating the firmware from the System Settings Screen](#))

8. Slide  toward  until “Goodbye See You!” appears on the display.  
The display will become empty, and the power will turn off.

9. Slide  toward  again.  
The update will be executed automatically, and the REC indicator will blink slowly.

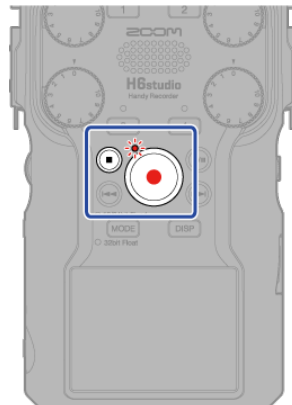

**After about 1 minute, a completion screen will appear.**



**NOTE**

During the firmware update, do not turn the power off or remove the microSD card.

If the update fails, the REC indicator will blink rapidly. If this happens, turn the power off once and confirm that the microSD card is loaded correctly. Then, turn the power on and try updating again.

**10.** Turn the power off.

**NOTE**

If the firmware update failed, starting the unit might not be possible and the REC indicator might stay lit.



Turn the power off and repeat the steps from the beginning.

→[Confirming that the firmware has been updated correctly](#)

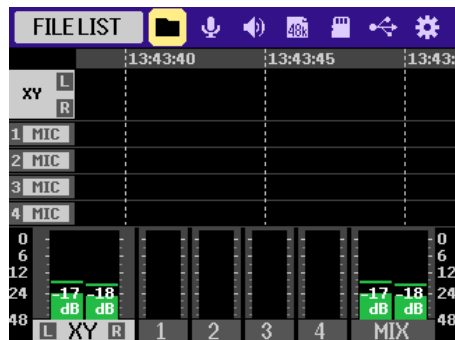

# Updating the firmware from the System Settings Screen

1. On the Home Screen, use  to select  and press  .  
This opens the System Settings Screen.



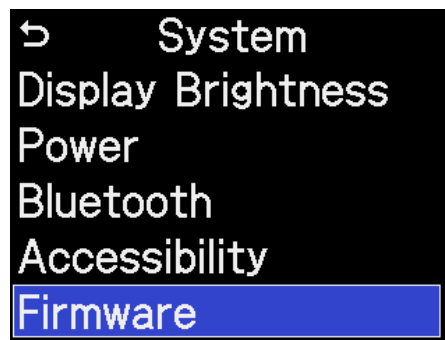

2. Use  to select "Firmware" and press  to confirm.



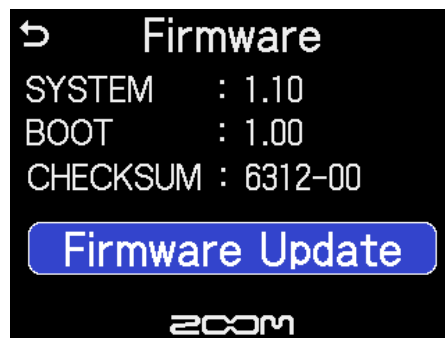



3. Use  to select "Firmware Update" and press  to confirm.

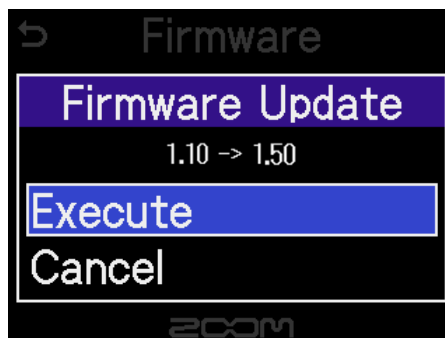

4. Use  to select "Execute" and press  .



5. Slide  toward  until “Goodbye See You!” appears on the display.  
The display will become empty, and the power will turn off.

6. Slide  toward  again.  
The update will be executed automatically, and the REC indicator will blink slowly.

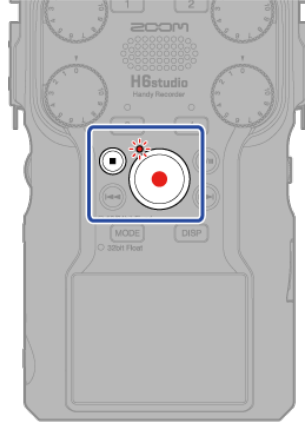

After about 1 minute, a completion screen will appear.



**NOTE**

During the firmware update, do not turn the power off or remove the microSD card.

If the update fails, the REC indicator will blink rapidly. If this happens, turn the power off once and confirm that the microSD card is loaded correctly. Then, turn the power on and try updating again.

7. Turn the power off.

**NOTE**

If the firmware update failed, starting the unit might not be possible and the REC indicator might stay lit.



Turn the power off and repeat the steps from the beginning.

# Confirming that the firmware has been updated correctly

Check the firmware versions used by the H6studio.

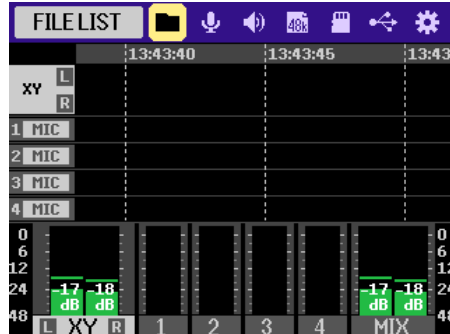
1. On the Home Screen, use  to select  and press  .  
This opens the System Settings Screen.



2. Use  to select “Firmware” and press  to confirm.

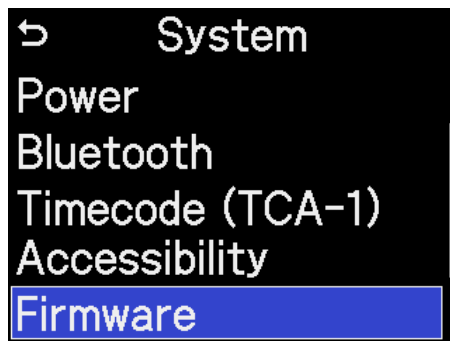

3. This shows the firmware versions.





## Confirming that the accessibility (Guide Sound) has been installed correctly

Check the audio guide used by the H6studio.

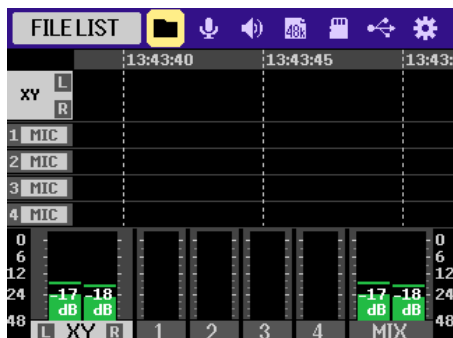
1. On the Home Screen, use  to select  and press . This opens the System Setting Screen.



2. Use  to select "Accessibility" and press  to confirm.

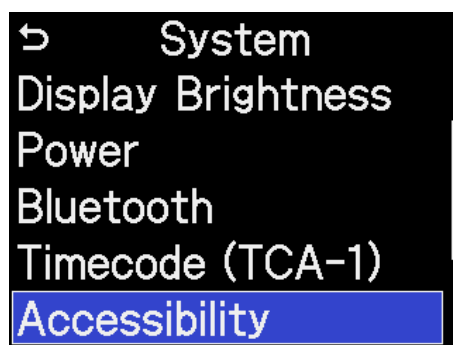

3. Use  to select "Version" and press  to confirm.

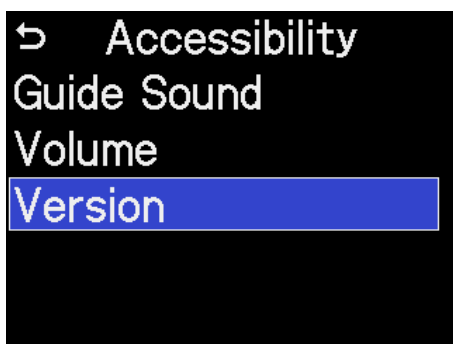

4. Check the language and version being used for the audio guide.

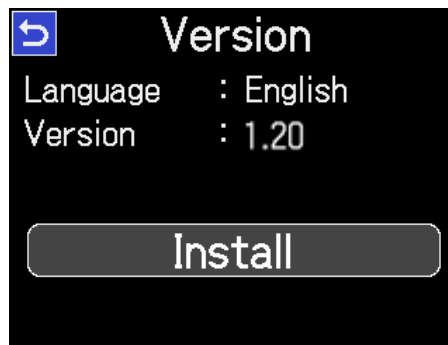

• ZOOM CORPORATION will bear no responsibility for any losses or third-party claims resulting from the use of this software. Moreover, distribution, sale, leasing, rental, alteration, and reverse engineering without permission of this software are prohibited. The specifications of this software and the contents of this document could be changed without notice in the future.

- Copying or reprinting this manual in whole or in part without permission is prohibited.
- Windows® is a trademark or registered trademark of Microsoft® Corporation.
- macOS® is a trademark or registered trademark of Apple Inc.
- microSDXC logos are trademarks of SD-3C LLC.
- Other product names, registered trademarks and company names in this document are the property of their respective companies.
- All trademarks and registered trademarks in this document are for identification purposes only and are not intended to infringe on the copyrights of their respective owners.
- The illustrations in these instructions might differ from actual screens.