

# H2essential Accessibility Installation Guide

Copyright(C) 2024 ZOOM CORPORATION. All Rights Reserved.

Proper display is not possible on grayscale devices.

## Introduction

### ■ Item to prepare

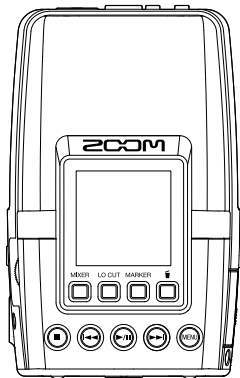

H2essential

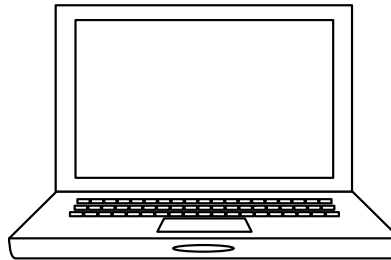

Windows or macOS computer  
with Internet access

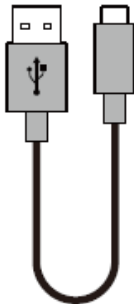

USB Type-C cable



microSD card

Supported recording media  
microSDHC: 4 GB – 32 GB  
microSDXC: 64 GB – 1 TB

Always format microSD cards on the H2essential after purchasing them new or using them with a different device.

## Product part names

Please refer to “Functions of parts” in the Operation Manual or the “H2essential Layout Description” document (for screen readers).

The Operation Manual and the “H2essential Layout Description” (for screen readers) can be downloaded from the H2essential Support & Downloads page ([zoomcorp.com/help/h2essential](https://zoomcorp.com/help/h2essential)).

## Accessibility installation process

1. Download the accessibility installation file.
2. Extract the ZIP file.
3. Copy the extracted accessibility installation file to a microSD card.
4. Install the guide sound accessibility feature.
5. Confirm that the guide sound accessibility feature has been installed correctly.

## Installing the Guide Sound Accessibility Feature

**This guide explains installing guide sound of English version 1.00 as an example.**

**If the H2essential firmware is old, update to the latest firmware before installing accessibility functions.**

1. Download the accessibility installation file.

Download the zip file that contains the accessibility installation file from the H2essential Support & Downloads page ([zoomcorp.com/help/h2essential](http://zoomcorp.com/help/h2essential)).

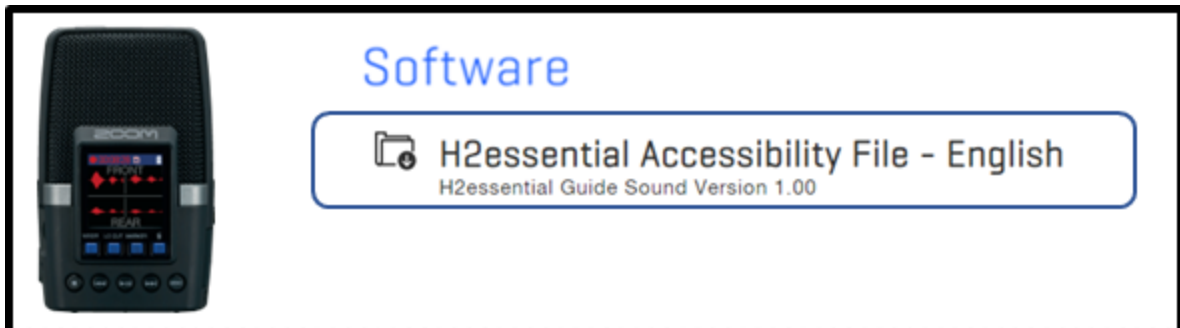

## On Windows

### 2. Extract the ZIP file

Select the folder that contains the downloaded ZIP file. Click ①“Compressed Folder Tools” and then click ②“Extract all”. This extracts the ZIP file.

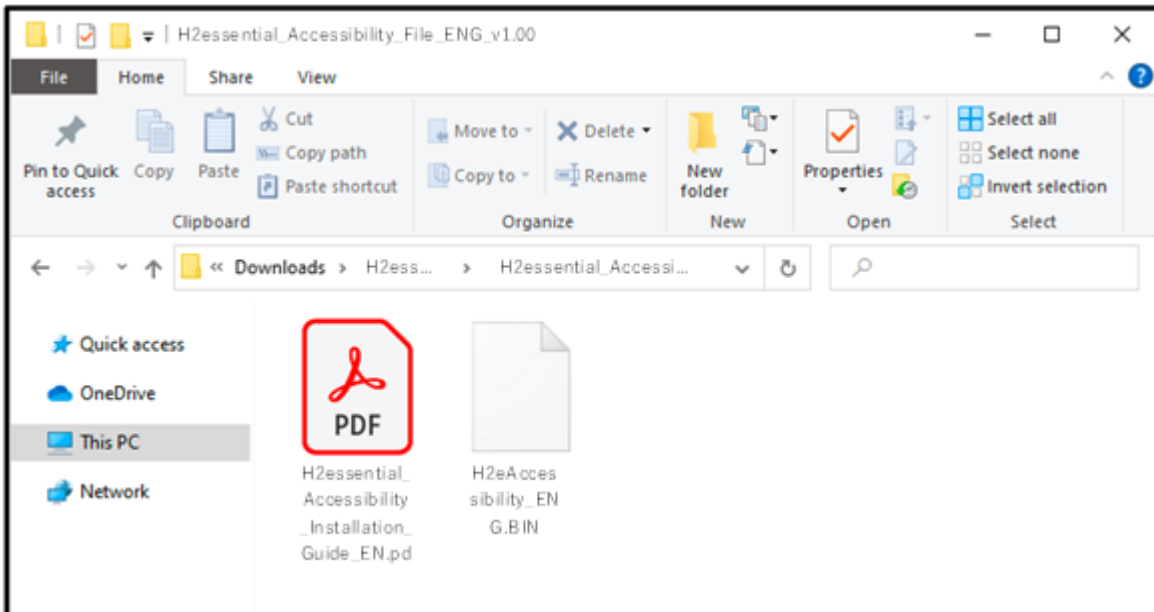
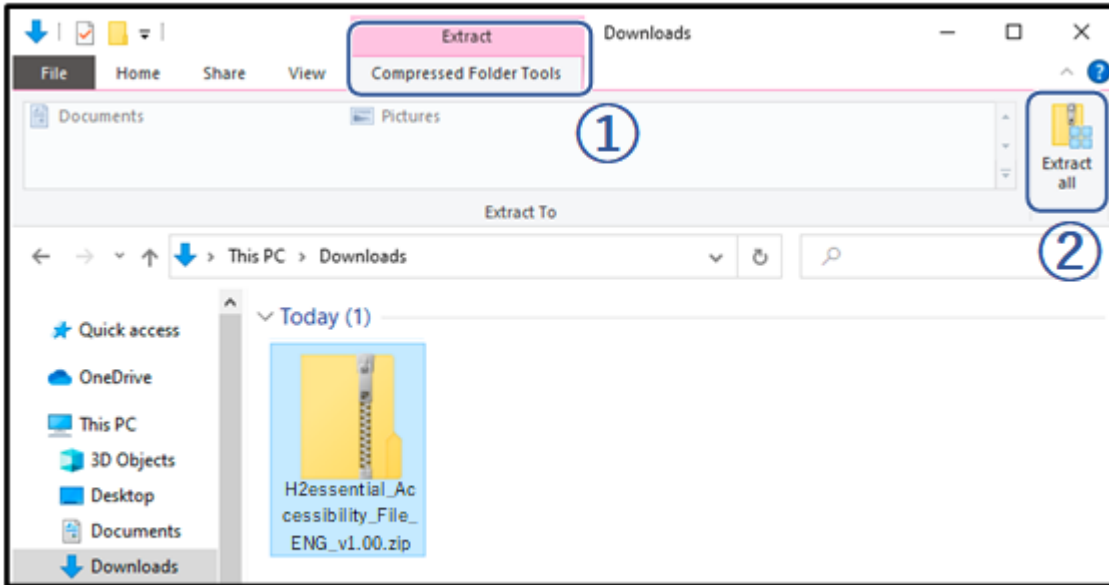

3. Copy the accessibility installation file to a microSD card  
Copy the “H2eAccessibility\_ENG.BIN” file to a microSD card.

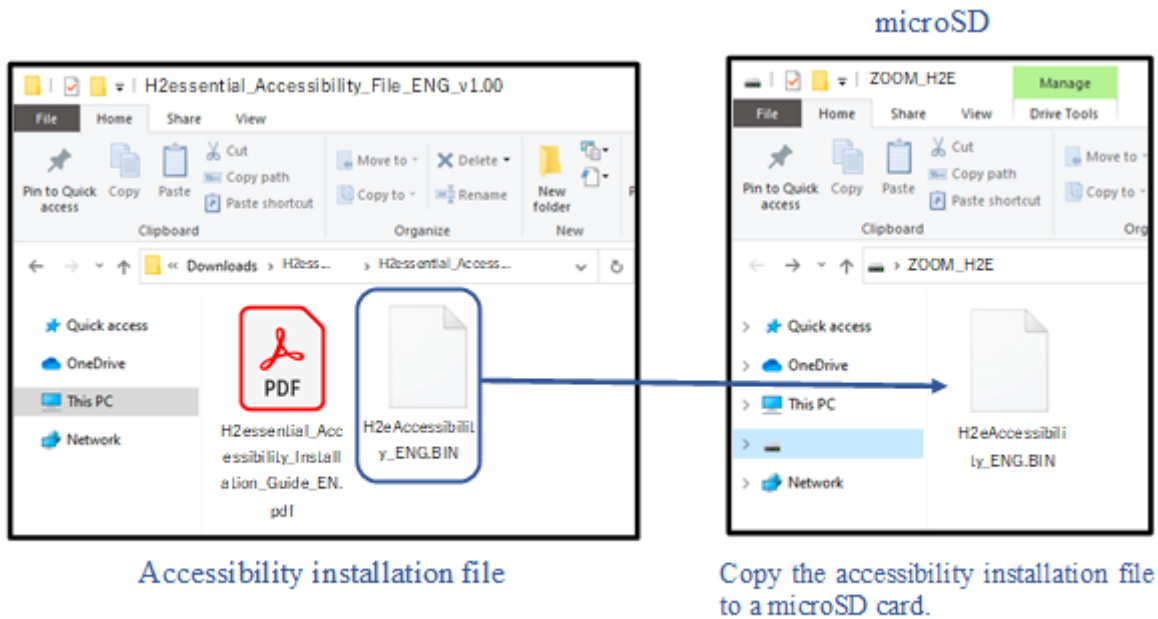

[NOTE]

Put only the accessibility installation file for one language on the microSD card.  
Proper installation might not be possible if multiple accessibility installation files are on a microSD card.

## On macOS

### 2. Extract the ZIP file.

After downloading, open the ①“Downloads” folder which appears at the right end of the Dock by default.

Then, click ②”H2essential\_Accessibility\_File\_ENG\_v1.00.zip”. Downloaded files will be shown.



### 3. Copy the accessibility installation file to a microSD card.

Copy the “H2eAccessibility\_ENG.BIN” file to a microSD card.

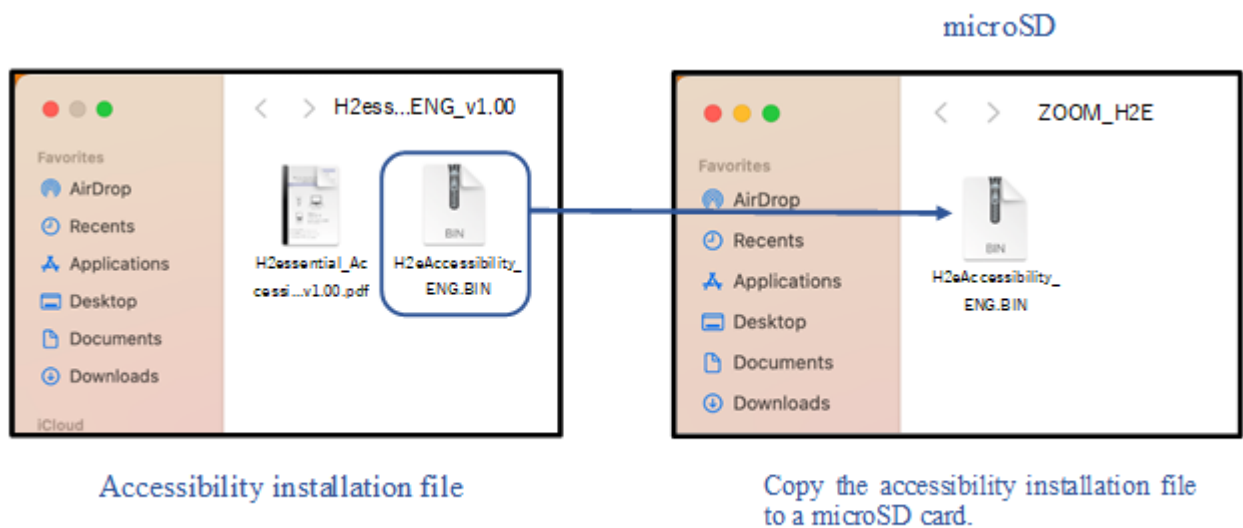

#### [NOTE]

Put only the accessibility installation file for one language on the microSD card. Proper installation might not be possible if multiple accessibility installation files are on a microSD card.



## The following procedures are the same on both Windows and macOS.

4. Connect the power source (AC adapter, USB bus power or portable battery) to the USB port (Type-C) of H2essential.  
[NOTE]

When performing an accessibility installation using batteries, installation may not be possible depending on the remaining battery charge.

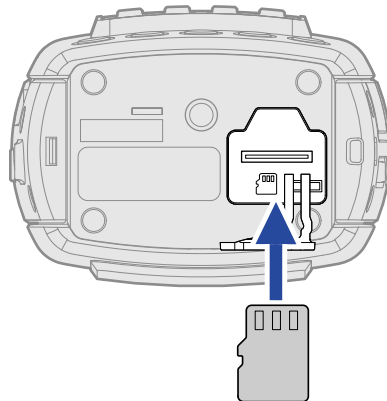
5. Insert the microSD card into the H2essential.



6. Slide  (POWER/HOLD switch) toward  (toward the unit bottom) until the power turns on.

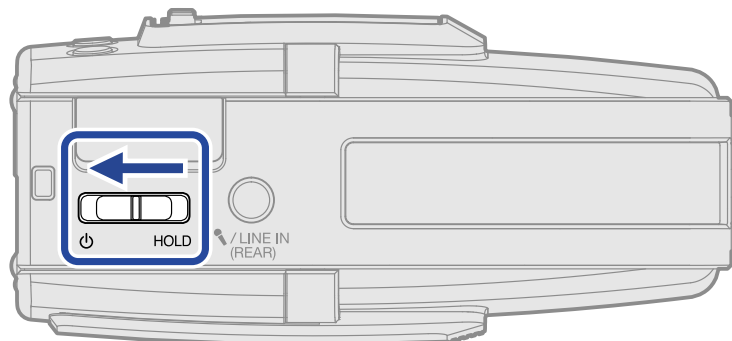

The installation of the audio guide will start automatically. Installation takes about thirty seconds.

After installation completes, the Home Screen will open.

### [NOTE]



During the accessibility installation, do not turn the power off or remove the microSD card.

Try again if installation fails.



# Confirm that the guide sound accessibility feature has been installed correctly

Check the guide sound information used by the H2essential.

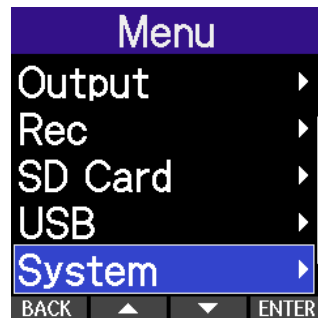

1. Press  (MENU button) when the Home Screen is open.  
This opens the Menu Screen.

2. Use  (operation button 2) and  (operation button 3) to select “System”, and press  (operation button 4) to confirm.



3. Use  (operation button 2) and  (operation button 3) to select “Accessibility”, and press  (operation button 4) to confirm.



4. Use  (operation button 2) and  (operation button 3) to select “Version”, and press  (operation button 4) to confirm.



5. Check the language and version used for the accessibility guide sound.



• ZOOM CORPORATION will bear no responsibility for any losses or third-party claims resulting from the use of this software. Moreover, distribution, sale, leasing, rental, alteration, and reverse engineering without permission of this software are prohibited. The specifications of this software and the contents of this document could be changed without notice in the future

- Copying or reprinting this manual in part or in whole without permission is prohibited.
- Microsoft and Windows are trademarks of the Microsoft group of companies.
- macOS® is a trademark or registered trademark of Apple Inc.
- microSDXC logos are trademarks of SD-3C LLC.
- Other product names, registered trademarks and company names in this document are the property of their respective companies.
- All trademarks and registered trademarks in this document are for identification purposes only and are not intended to infringe on the copyrights of their respective owners.
- The illustrations in these instructions might differ from actual screens.