

# UAC - 232

## USB AUDIO CONVERTER

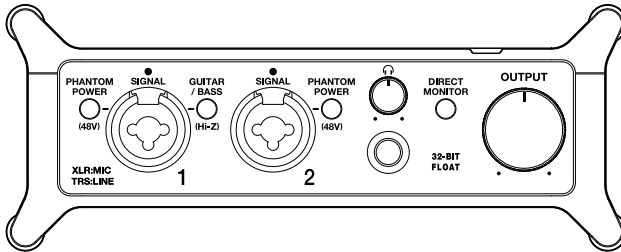

## Quick Tour

An Operation Manual with more detailed explanations and other documents related to this product can be viewed on the following website.



[www.zoom.jp/docs/uac-232](http://www.zoom.jp/docs/uac-232)

**You must read the Usage and Safety Precautions before use.**

# Making connections

## Connecting the UAC-232 to a computer

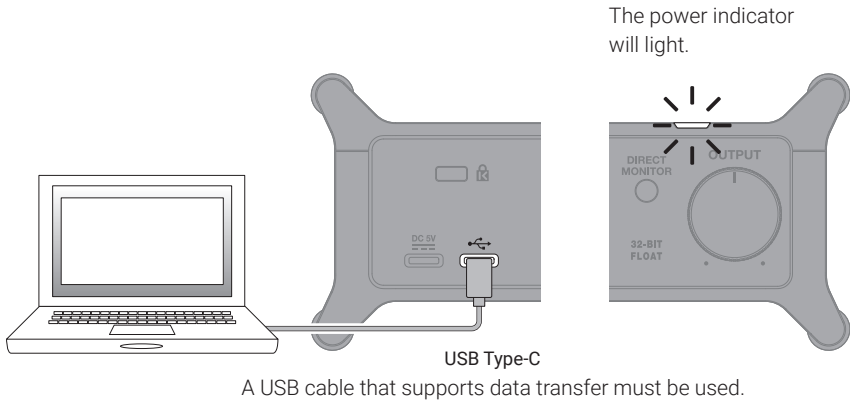

### ■ Mac

In the Audio MIDI Setup app on the Mac, select the ZOOM UAC-232 in the Audio Devices window, and set the input and output formats to 32-bit float.

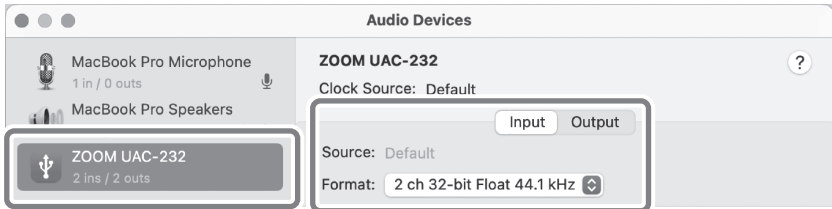

### ■ Windows

A dedicated driver must be installed.

Download it from the product page on the ZOOM website ([zoomcorp.com](http://zoomcorp.com)) and follow the instructions in the installation guide to install it.

USB cables and adapters that match the connectors are necessary to connect iOS and iPadOS devices.

# Connecting instruments

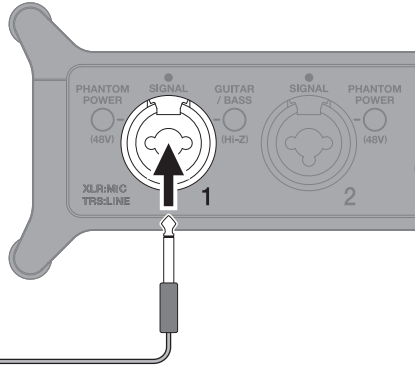
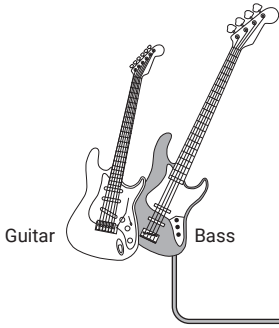

When directly connecting a guitar or bass, press **GUITAR / BASS** so that it lights.

# Connecting mics

Dynamic mic    Condenser mic

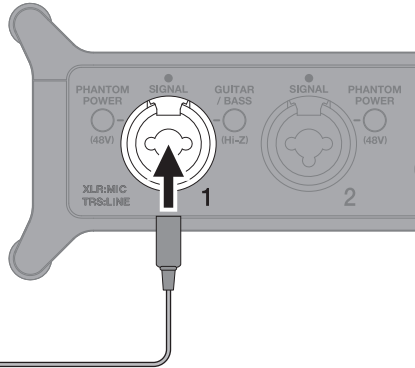
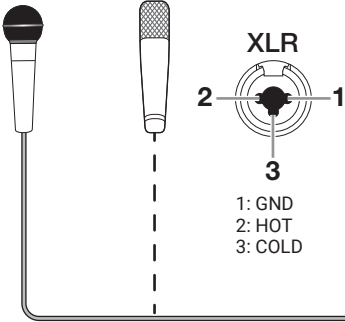

When connecting a condenser mic, press **PHANTOM POWER** so it lights.

## Connecting keyboards and mixers

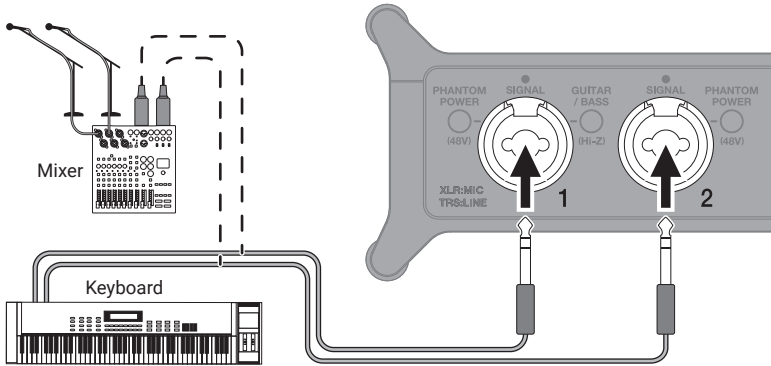

## Connecting MIDI Devices

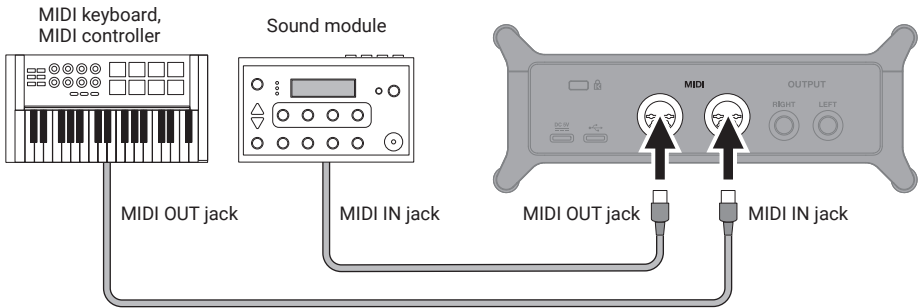

When using a MIDI port with a DAW, for example, follow the instructions below when making settings. The UAC-232 or ZOOM UAC-232 Mix Control might not function properly otherwise.

### Mac

Use ZOOM UAC-232 MIDI I/O Port. Do not use for ZOOM UAC-232 Mix Control.

### Windows

Use ZOOM UAC-232 MIDI. Do not use MIDIIN2/MIDIOUT2 (ZOOM UAC-232 MIDI).

# Connecting headphones and monitor speakers

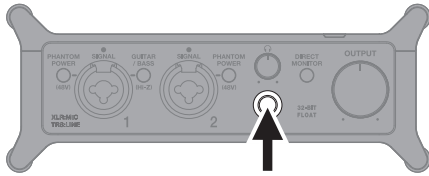

Headphones

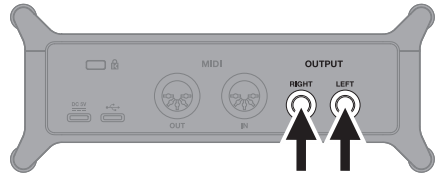

Monitor speakers

Connect the monitor speakers before powering them.

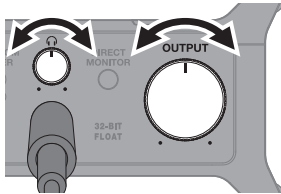

## Adjusting the volume

These adjust volumes independently.

# Enabling direct monitoring

Input sounds can be monitored with low latency before they pass through the computer.

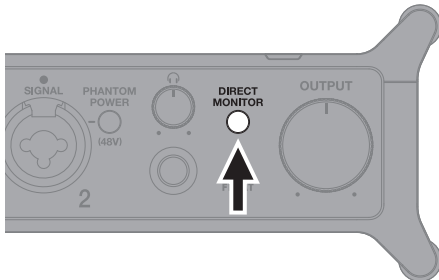

**DIRECT MONITOR**  
Press **MONITOR** so that it lights.

When using direct monitoring, mute the monitoring sound output from the DAW app.

## ZOOM UAC-232 Mix Control app



The dedicated ZOOM UAC-232 Mix Control app, which supports Windows/Mac computers and iOS/iPadOS devices, can be used to control the internal mixer of the UAC-232 and adjust the stereo mix for direct monitoring and streaming. Download it from the ZOOM website ([zoomcorp.com](http://zoomcorp.com)) or the App Store.

# Recording

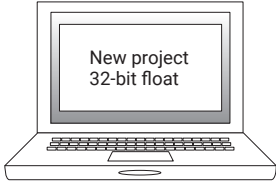

**1**

Launch the DAW app and create a project with 32-bit float resolution.

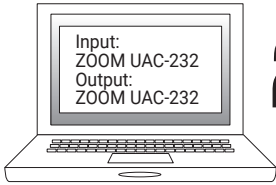

**2**

Select the ZOOM UAC-232 as the input device.

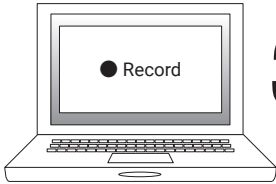

**3**

Recording

Refer to the DAW app manual for details about how to use it.

# Functions of parts

## ■ Front

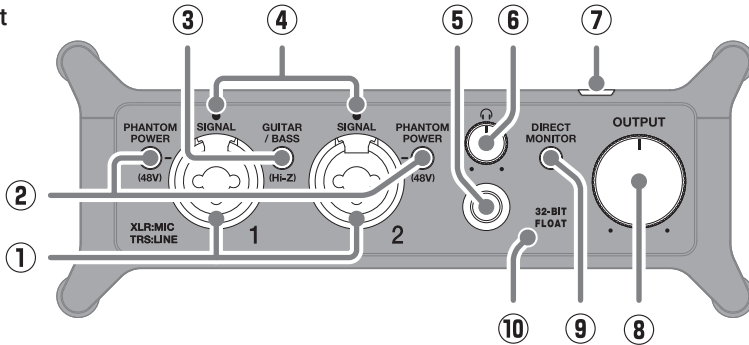

### ① Input jacks 1-2

These input jacks have built-in mic preamps. Connect mics, keyboards, guitars and other audio sources to them. These can be used with both XLR and standard phone (balanced or unbalanced) plugs.

### ② PHANTOM POWER switches

These turn +48V phantom power on/off. Set these to on when connecting condenser mics.

### ③ GUITAR/BASS switch

Use this to enable Hi-Z support for the Input jack 1 circuit. Turn this on as necessary for the connected guitar or bass.

### ④ SIGNAL indicators

These light when signals are being input.

### ⑤ PHONES jack

This outputs a stereo signal. Connect headphones here.

### ⑥ PHONES knob

Use this to adjust the headphone volume.

### ⑦ Power indicator

This lights when the power is on.

### ⑧ OUTPUT knob

Use this to adjust the volume of the signals output from the OUTPUT jacks.

### ⑨ DIRECT MONITOR switch

Turn this on to directly monitor sounds from the input jacks before they pass through the computer.

### ⑩ 32-BIT FLOAT indicator

This lights when the UAC-232 is operating at 32-bit float resolution.

## ■ Back

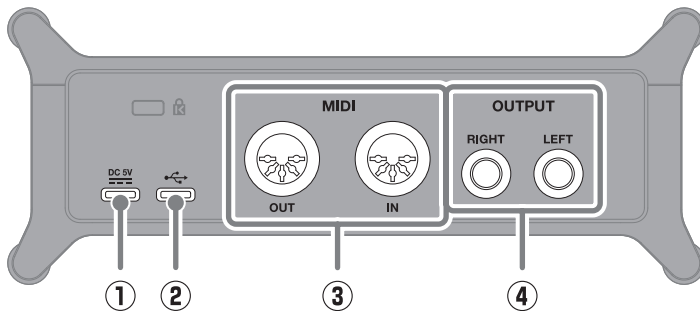

### ① DC 5V port (Type-C)

Use this power supply USB port to connect an AC adapter or portable battery.

### ② USB (Type-C) port

Use this USB port to connect with a computer or iOS/iPadOS device.

### ③ MIDI IN/OUT connectors

Connect the MIDI OUT and IN connectors of other MIDI devices here.

### ④ OUTPUT connectors

These output the left (L) and right (R) channels of stereo signals. Connect these to speakers with built-in amplifiers, for example.

# Troubleshooting



## Not recognized by computer when connected

- Use a USB cable that supports data transfer.
- Confirm that the USB cable is connected to  on the UAC-232, not to .

## Cannot select or use the UAC-232 device

- Confirm that the UAC-232 has been connected correctly on the computer.
- Quit all software that is using the UAC-232. Then, disconnect and reconnect the USB cable connected to the UAC-232.
- Connect the UAC-232 directly to a USB port on the computer. Do not connect it using a USB hub.
- When connecting to a Windows computer, installing the dedicated driver can resolve problems not only with DAWs but also with other applications.
- Reinstall the driver.



## The sounds of devices connected to input jacks are distorted, too quiet or silent

- When using a condenser mic, set  to ON.
- Use  or  to adjust the volume.
- Use UAC-232 Mix Control to adjust the waveform display size.

## Cannot play or record

- Confirm that "ZOOM UAC-232" is selected in the "Sound" settings of the computer being used.
- Confirm that UAC-232 is set for input and output in the software being used.
- Quit all software that is using the UAC-232. Then, disconnect and reconnect the USB cable connected to the UAC-232.

## Playback sound cannot be heard or is quiet

- Check the connections and volume settings of the speakers.
- Use  or  to adjust the volume.

## Cannot be used with an iOS/iPadOS device

- Confirm that the external power supply is connected correctly.

## Sound skips during playback or recording

- If the audio buffer size of the software being used can be adjusted, increase it.
- Turn off the automatic sleep function and other computer power saving settings.
- Connect the UAC-232 directly to a USB port on the computer. Do not connect it using a USB hub.

Product names, registered trademarks and company names in this document are the property of their respective companies. All trademarks and registered trademarks in this document are for identification purposes only and are not intended to infringe on the copyrights of their respective owners.

# ZOOM®

ZOOM CORPORATION

4-4-3 Kanda-surugadai, Chiyoda-ku, Tokyo 101-0062 Japan

[zoomcorp.com](http://zoomcorp.com)