

# M4

## MicTrak

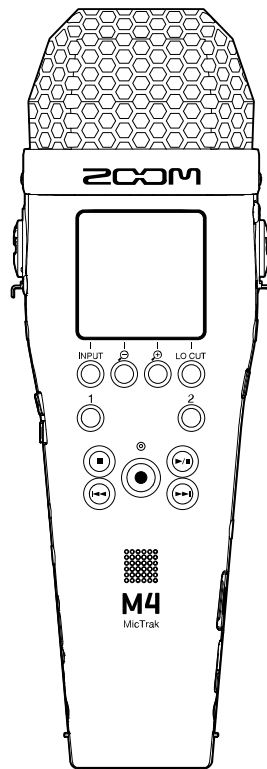

# Operation Manual

You must read the Usage and Safety Precautions before use.

©2023 ZOOM CORPORATION

Copying or reprinting this manual in part or in whole without permission is prohibited.

Product names, registered trademarks and company names in this document are the property of their respective companies. All trademarks and registered trademarks in this document are for identification purposes only and are not intended to infringe on the copyrights of their respective owners.

Proper display is not possible on grayscale devices.

# Notes about this Operation Manual

---

You might need this manual in the future. Always keep it in a place where you can access it easily. The contents of this document and the specifications of the product could be changed without notice.

- Microsoft and Windows are trademarks of the Microsoft corporate group.
- Mac, macOS and iPadOS are trademarks of Apple Inc.
- iOS is a registered trademark or trademark of Cisco Systems, Inc. and affiliated companies in the USA and other countries, and it is used under license.
- Android™ is a registered trademark of Google LLC.
- The microSDXC logo is a trademark of SD-3C LLC.
- Recording from copyrighted sources, including CDs, records, tapes, live performances, video works and broadcasts, without permission of the copyright holder for any purpose other than personal use is prohibited by law. ZOOM CORPORATION will not assume any responsibility related to infringements of copyrights.

# Contents

---

Notes about this Operation Manual.....	2
M4 overview.....	5
Realizing high audio quality throughout recording and editing.....	5
Functions of parts.....	9
Overview of main screens.....	14
Recording process.....	21
Making preparations.....	22
Inserting microSD cards.....	22
Supplying power.....	23
Connecting input devices.....	26
Turning the power on/off.....	31
Setting the language shown (first time starting up).....	32
Setting the date format (first time starting up).....	33
Setting the date and time (first time starting up).....	34
Setting the type of batteries used (first time starting up).....	35
Preventing misoperation (hold function).....	36
Making input settings.....	37
Selecting inputs for making settings.....	37
Changing the audio format used for input from the built-in XY mic.....	40
Setting INPUT 1/2 sources, phantom power and stereo linking.....	42
Reducing noise (low-frequency cut).....	44
Changing phantom power voltage.....	45
Using plugin power.....	47
Switching the left and right audio signals input from the built-in XY mic.....	48
Making output settings.....	49
Adjusting the line output level.....	49
Recording.....	50
Adjusting the volume display size to make checking easier.....	50
Monitoring input and playback sounds.....	51
Making recording settings.....	52
Recording.....	56
Adding marks during recording.....	57
Playing recordings.....	58
Playing recordings.....	58
Adding/deleting marks during playback.....	61
Using automatic playback volume adjustment.....	62
Managing files.....	63
M4 folder and file structure.....	63
Checking files (FILE LIST Screen).....	66
Deleting files.....	68

Optimizing file volume (normalization).....	70
Changing bit depth and exporting files (Export).....	71
Checking file information.....	73
<b>Using as a USB mic.....</b>	<b>74</b>
For Windows.....	74
Connecting computers, smartphones and tablets.....	74
USB mic muting.....	78
Disconnecting from computers, smartphones and tablets.....	79
Making USB mic settings.....	80
<b>Transferring files to computers and other devices.....</b>	<b>84</b>
Connecting computers, smartphones and tablets.....	84
Disconnecting from computers, smartphones and tablets.....	86
<b>Managing microSD cards.....</b>	<b>87</b>
Formatting microSD cards.....	87
Testing microSD cards.....	89
<b>Using timecode.....</b>	<b>93</b>
Timecode overview.....	93
Making timecode settings.....	96
<b>Making various settings.....</b>	<b>102</b>
Setting the language shown.....	102
Setting the date and time.....	103
Setting the date format.....	105
Setting display power saving.....	107
Setting the display brightness.....	109
Setting the type of batteries used.....	111
Setting the time until the power turns off automatically.....	113
<b>Restoring factory default settings.....</b>	<b>115</b>
<b>Managing the firmware.....</b>	<b>116</b>
Checking firmware versions.....	116
Updating the firmware.....	117
<b>Using optional remote controls.....</b>	<b>118</b>
<b>Appendix.....</b>	<b>119</b>
Troubleshooting.....	119
M4 metadata lists.....	122
<b>Specifications.....</b>	<b>126</b>

# M4 overview

---

## Realizing high audio quality throughout recording and editing

With dual A/D converter circuits and support for 32-bit float WAV files, the M4 enables the highest audio quality to be maintained from recording to editing in a DAW or other software.

### Recording

Dual AD converter circuits enable recording from quiet to loud volumes without any need to make gain adjustments.



### Editing in DAWs and other software

Recording with 32-bit float WAV file format allows the recording audio quality to be retained when editing.



# Dual A/D converter circuit overview

For each input circuit, the M4 has two A/D converters with different input gains. This design enables high-quality audio recording without the need to adjust gain settings, a step that normally had been indispensable.

## Providing amazing dynamic range

By combining two A/D converters, a wide dynamic range not possible with a single A/D converter has been realized.

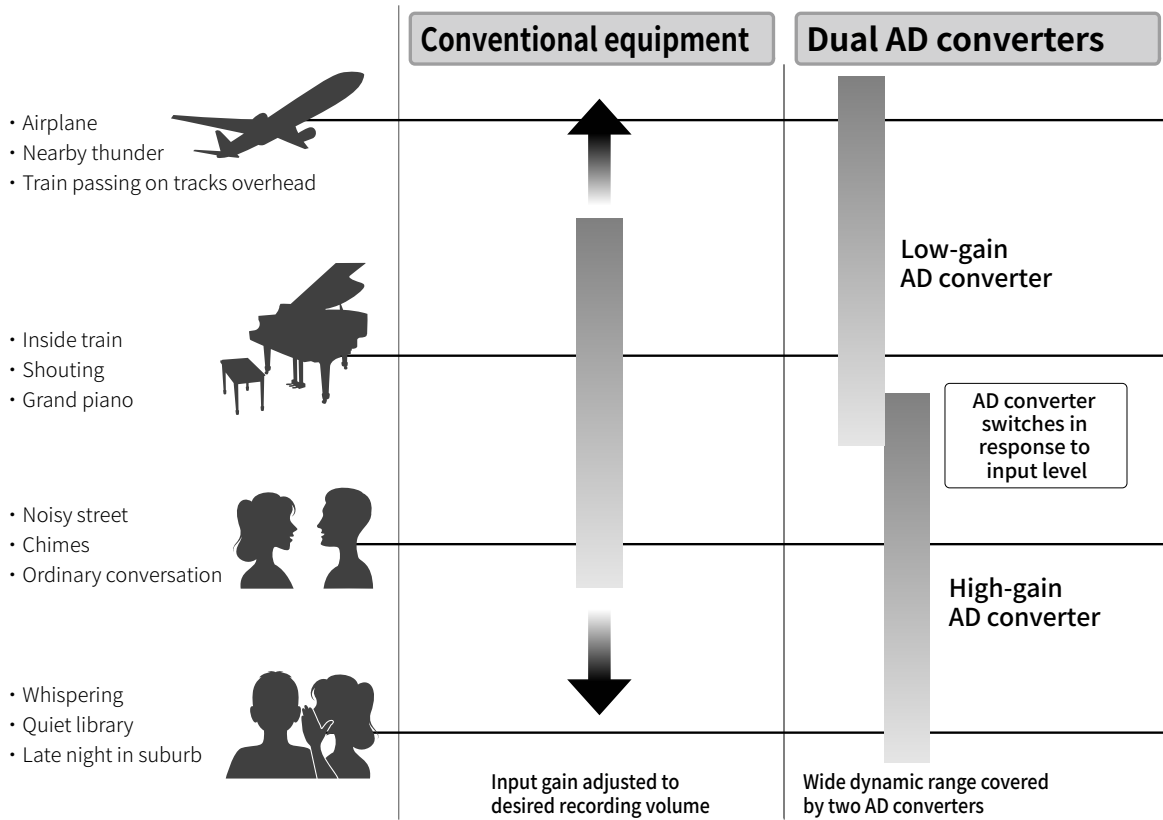

## Switching between two A/D converters

The M4 constantly monitors data from the two A/D converters and automatically selects the one that provides the best recording results.

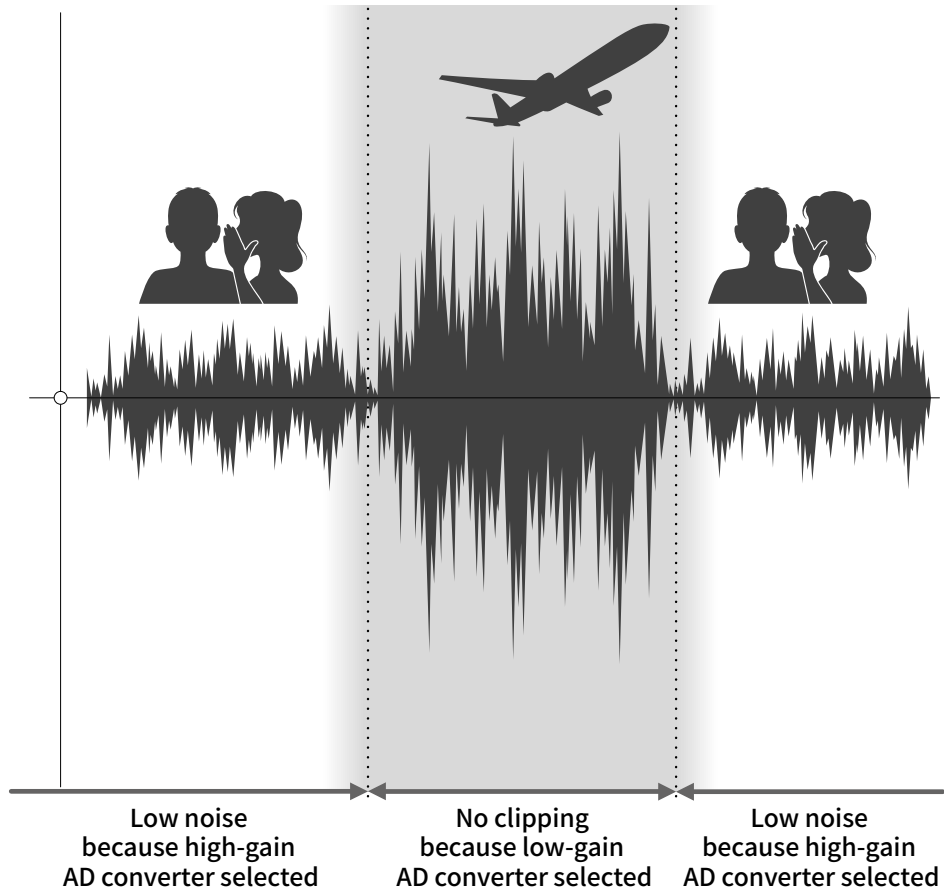

## 32-bit float WAV file overview

---

32-bit float WAV files have the following advantages over conventional 16/24-bit WAV files.

These features enable the quality of the sound during recording to be maintained even when editing with DAW software afterward.

### Resolution advantage

32-bit float WAV files have the advantage of being able to maintain high resolution even at low volumes. As a result, quiet sounds can be made louder when editing after recording without degrading their quality.

#### ■ 16/24-bit WAV



#### ■ 32-bit float WAV



### Clipping advantage

If a waveform sounds clipped when output from the M4 or in a DAW, it can be edited after recording to lower its volume and restore an unclipped waveform because the data in the 32-bit float WAV file itself is not clipped.

#### ■ 16/24-bit WAV

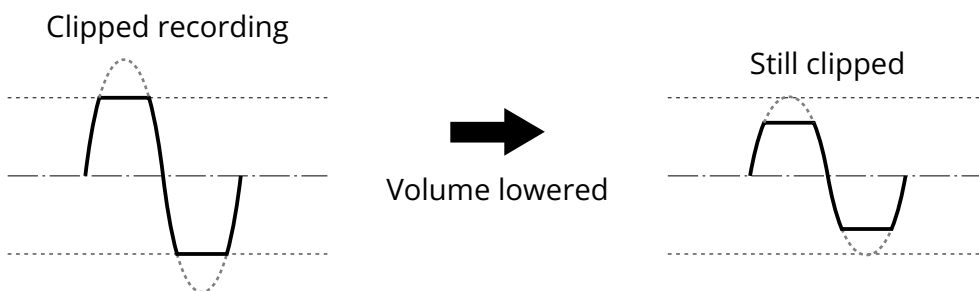

#### ■ 32-bit float WAV

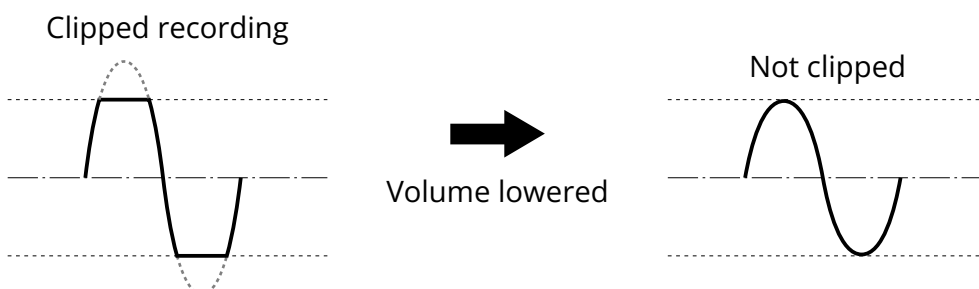



# Functions of parts

## Front and back

### ■ Front

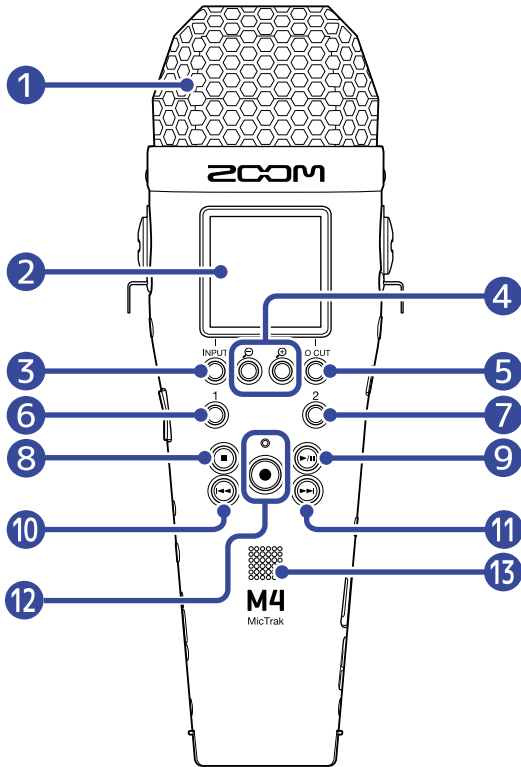

### ■ Back

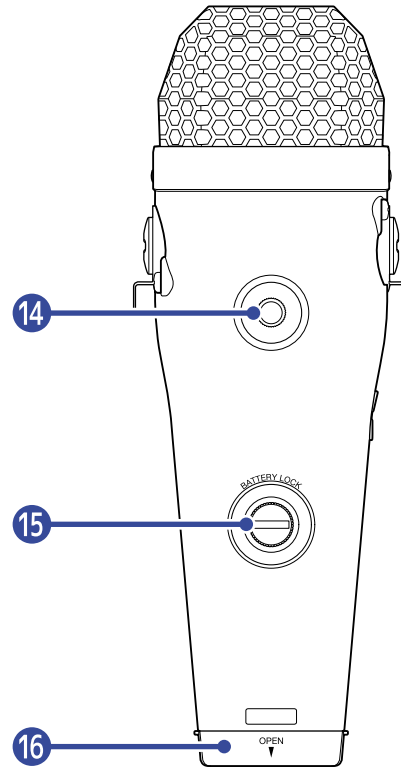

#### 1 Built-in XY mic

This stereo mic has two crossing directional mics. This mic can record three-dimensional sound with natural depth and width.

#### 2 Display

This shows various types of information.

#### 3 INPUT/operation button

Home Screen: Change input format of built-in XY mic and set INPUT 1/2 sources.

Other screens: Use operation shown by icon at bottom of screen. (→ [Operation button overview](#))

#### 4 /Operation buttons

Home Screen: Change volume amplification on the display.

Other screens: Use operation shown by icon at bottom of screen. (→ [Operation button overview](#))

#### 5 LO CUT/operation button

Home Screen: Change LO CUT setting.

Other screens: Use operation shown by icon at bottom of screen. (→ [Operation button overview](#))

#### 6 1 button

Switch input set on the Home Screen (INPUT 1 or built-in mic).

- 7 2 button**  
Switch input set on the Home Screen (INPUT 2 or built-in mic).
- 8 STOP button**  
This stops recording and playback.  
Press this when playing or paused to close the Playback Screen and open the Home Screen.
- 9 PLAY/PAUSE button**  
This starts and pauses playback.  
When used as a USB mic, this mutes/unmutes it.
- 10 REW button**  
When playing or paused, this will move to the take before the current one, the beginning of the current take, or the mark before the current position.  
Press and hold to search backward.
- 11 FF button**  
When playing or paused, this will move to the take or mark after the current one.  
Press and hold to search forward.
- 12 REC button/indicator**  
This starts recording. The REC indicator lights during recording.  
Press when recording or playing to add a mark at that point.
- 13 Speaker**  
Sound is output here during file playback.  
Audio will not be output from the speaker if a pair of headphones or another device, for example, is connected to the headphone jack or the LINE OUT jack.
- 14 Tripod mounting threads**  
This can be used to attach the M4 to a tripod, for example.
- 15 Battery compartment locking screw**  
Use this when installing and removing the battery compartment. (→ [Installing batteries](#))
- 16 Battery compartment**  
Install batteries here.  
To remove the battery compartment, loosen the battery compartment locking screw. (→ [Installing batteries](#))

## ■ Operation button overview

When operation icons are shown at the bottom of the Menu Screen and Playback Screen, for example, use the corresponding operation buttons (which are right below the icons) to select and confirm items on the screen.

## ■ Menu Screen example

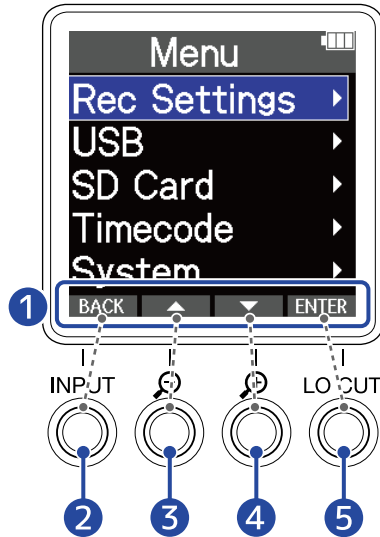

- 1 Operation icons**  
The icons shown depend on the screen.
- 2 Operation button ( **BACK** )**  
Reopen the previous screen.
- 3 Operation button ( **▲** )**  
Select the item above.
- 4 Operation button ( **▼** )**  
Select the item below.
- 5 Operation button ( **ENTER** )**  
Confirm the selected item.

Other operation icons will also be shown. See the explanations of procedures for each item for details.

## ■ Abbreviation of procedures in this operation manual

In this operation manual, procedures that involve pressing operation buttons are shown with icons in the following manner.

Example: Use the buttons that correspond to **▲** and **▼** to select "Rec Settings". Then, use the button that corresponds to **ENTER** to confirm the selected item.

→ Use **▲** / **▼** to select "Rec Settings" and press **ENTER** to confirm.

# Left and right sides

## Left side

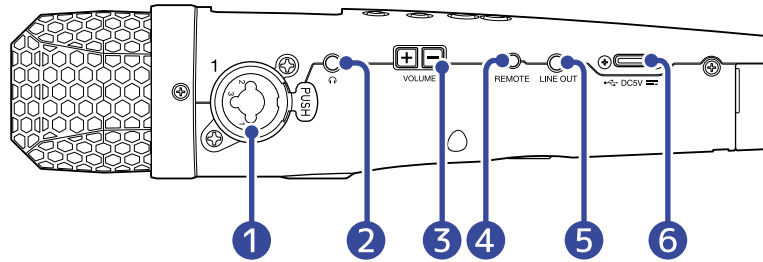

## Right side

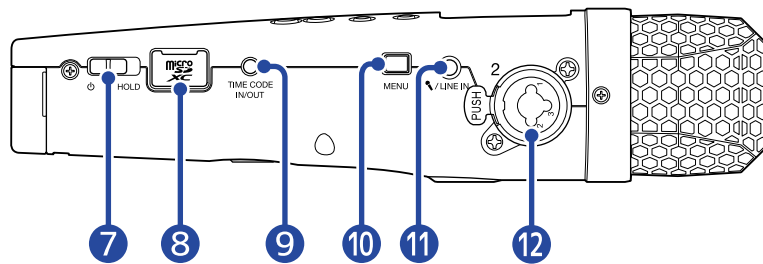

### 1 INPUT 1 jack

Connect a mic or instrument here. This can be used with XLR and TRS plugs. When disconnecting an XLR plug, pull it while pushing the connector lock release button.

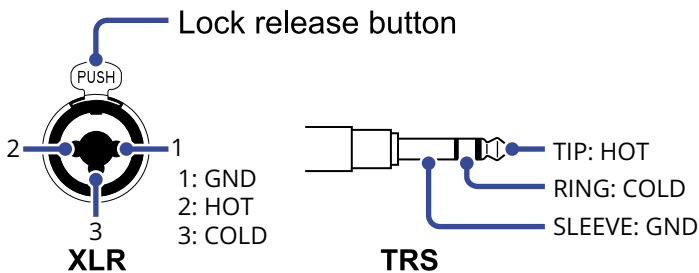

### 2 Headphone jack

This can output sound to headphones.

### 3 VOLUME buttons

Use these to adjust the volume of the headphones/built-in speaker.

### 4 REMOTE jack

A dedicated remote control (ZOOM RC2, RC4, RCH-5 or RCH-6) can be connected here. This enables operating the M4 from a distance.

### 5 LINE OUT jack

This outputs sound to a connected device.

### 6 USB port (Type-C)

Connect this to a computer, smartphone or tablet to use file transfer and to use it as a USB mic. This supports operation on USB bus power.

**7 POWER/HOLD switch**

Use this to turn the power on/off and to disable button operation.

**8 microSD card slot**

Insert a microSD card here.

**9 TIME CODE IN/OUT jack**

This inputs and outputs timecode.

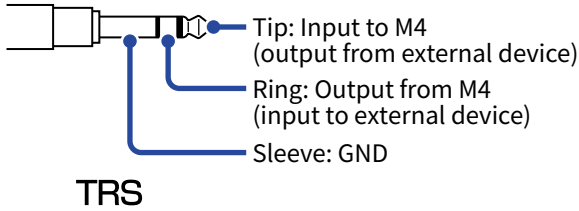

**10 MENU button**

This opens the Menu Screen and returns to the Home Screen.

**11 MIC/LINE IN jack (supports plug-in power)**

A connected mic can be used to record.

Mics that require plug-in power can be used with this jack.

**12 INPUT 2 jack**

Connect a mic or instrument here. This can be used with XLR and TRS plugs.

When disconnecting an XLR plug, pull it while pushing the connector lock release button.

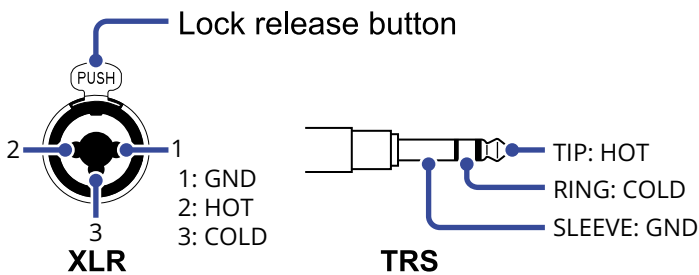

# Overview of main screens

This section explains the screens that are shown on the M4 display.

## Home Screen

This appears on the display when the M4 power is turned on. This shows the state of the M4, including the recording status and the waveforms of input signals.

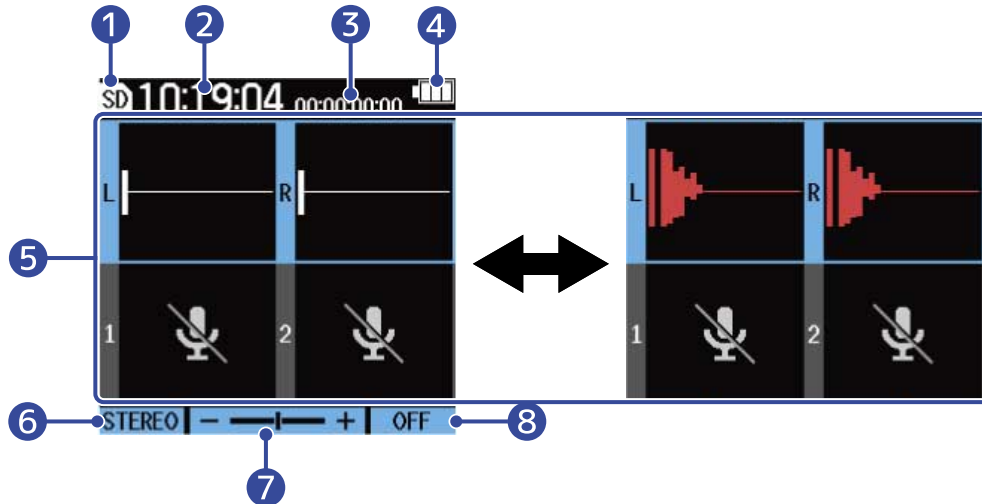

### 1 Status icon

This icon shows the recording status.

-  Stopped
-  Recording

### 2 Counter

This shows the available recording time when standing by and the current elapsed recording time when recording.

### 3 Timecode

This is shown when the timecode setting is enabled, for example. (→ [Using timecode](#))

### 4 Remaining battery charge indicator

This is shown when batteries are being used for operation. When the remaining battery charge becomes low, replace the batteries (→ [Installing batteries](#)), or connect an AC adapter (→ [Connecting an AC adapter](#)) or portable battery (→ [Using other power sources](#)).

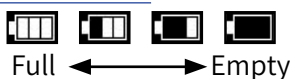

### 5 Volume/waveform display (built-in XY mic, INPUT 1/2)

This shows the volumes of the signals input to the M4. Waveforms appear red during recording.

(→ [Adjusting the volume display size to make checking easier](#))

Inputs are shown on the left edge of each volume display.

- L: Built-in XY mic left signal

- R: Built-in XY mic right signal
- 1: INPUT 1
- 2: INPUT 2

Various settings can be made for the selected input. (→ [Making input settings](#))

Use  and  to select inputs. (→ [Selecting inputs for making settings](#))

#### 6 Built-in XY mic input format (when built-in XY mic selected)

This shows the input format for the built-in XY mic. (→ [Changing the audio format used for input from the built-in XY mic](#))

Input source setting value (when INPUT 1 or INPUT 2 selected)

This shows the input source (INPUT 1 or INPUT 2). (→ [Setting INPUT 1/2 sources, phantom power and stereo linking](#))

#### 7 Volume amplification on the display



This shows the amplification of the volume shown on the display for the selected input.

Adjust this as necessary so that the volume shown is easy to check. (→ [Adjusting the volume display size to make checking easier](#))

#### 8 LO CUT setting

This shows the LO CUT setting for the selected input. (→ [Reducing noise \(low-frequency cut\)](#))

#### HINT

- When a screen other than the [Home Screen](#) is open, pressing  will open the Home Screen. This function is useful for returning quickly to the Home Screen from various setting screens. (Returning directly to the Home Screen is not possible from a few screens.)
- When the [Playback Screen](#) or [FILE LIST Screen](#) is open,  can be pressed to open the Home Screen.

# Playback Screen





When the [Home Screen](#) is open, pressing  to start playback will also open this screen.

This screen shows the M4 playback status, including the playback time and recording file waveform.



## 1 Status icon

Icons show the playback status.

-  Playing back
-  Paused
-  Searching backward
-  Searching forward

## 2 Playback time

This shows the time elapsed since the start of playback.

## 3 File length

This shows the length of the file that is currently playing.

## 4 Remaining battery charge indicator

This is shown when batteries are being used for operation. When the remaining battery charge becomes low, replace the batteries (→ [Installing batteries](#)), or connect an AC adapter (→ [Connecting an AC adapter](#)) or portable battery (→ [Using other power sources](#)).



## 5 Input types

This shows the types of inputs recorded.

- L: Built-in XY mic left signal
- R: Built-in XY mic right signal
- 1: INPUT 1
- 2: INPUT 2



## 6 Operation icons

By pressing the operation buttons below the corresponding operation icons on the display, the playback position can be skipped and the screen can be changed. The file can also be deleted or exported and information about it can be checked. (→ [Operation button overview](#))

## 7 Waveform display

This shows the waveforms of the recorded files being played.

Parts of waveforms that have already been played are shown in green.

Mark positions can also be checked. (→ [Adding marks during recording](#), [Adding/deleting marks during playback](#))

## 8 Mark bar

Bars show marks added to the file that is playing back.

---

### HINT

- Press  to stop playback and reopen the Home Screen.
  - Press **LIST** to open the [FILE LIST Screen](#).
-

## FILE LIST Screen

Press **LIST** when the [Playback Screen](#) is open to open this screen.

The files on the microSD card will be shown in a list on the display, so the content of the card can be checked and files can be played and deleted, for example.

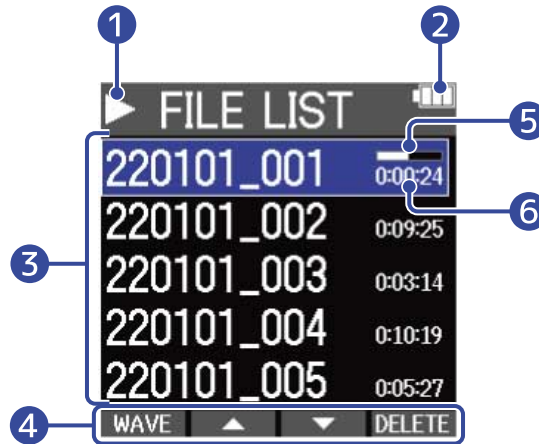

### 1 Status icon

Icons show the playback status.

- Playing back
- Paused
- Searching backward
- Searching forward

### 2 Remaining battery charge indicator

This is shown when batteries are being used for operation. When the remaining battery charge becomes low, replace the batteries (→ [Installing batteries](#)), or connect an AC adapter (→ [Connecting an AC adapter](#)) or portable battery (→ [Using other power sources](#)).



### 3 File list

This list shows the files on the microSD card.

The names and lengths of files are shown. A progress bar is shown for the selected file.

When the list has more files than will fit on the display, a scrollbar will appear on the right edge.

### 4 Operation icons

Files can be selected and deleted by pressing the operation buttons below the corresponding operation icons on the display. The screen can also be switched. (→ [Operation button overview](#))

### 5 Progress bar

This shows the current playback position.

### 6 Playback time/file length

When playing or paused, this shows the elapsed time from the start of playback. When stopped, this shows the file length.

---

## HINT

- Press  to stop playback and reopen the Home Screen.
  - Press **WAVE** to open the [Playback Screen](#).
-

# Menu Screen

Use the Menu Screen to make various settings, including recording, output and hardware settings.

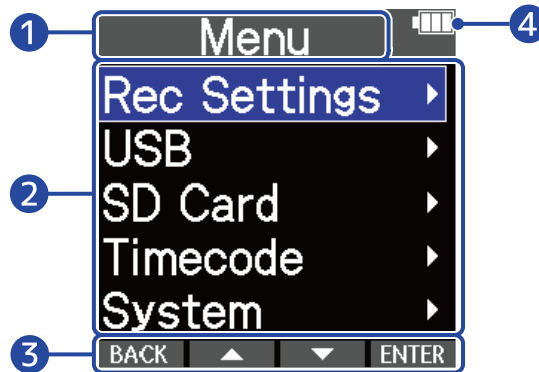

1 Menu title

2 Menu items

These include setting items and setting values.

3 Operation icons

By pressing the operation buttons below the corresponding operation icons on the display, menu items can be selected and selected items can be confirmed. (→ [Operation button overview](#))

4 Remaining battery charge indicator

This is shown when batteries are being used for operation. When the remaining battery charge becomes low, replace the batteries (→ [Installing batteries](#)), or connect an AC adapter (→ [Connecting an AC adapter](#)) or portable battery (→ [Using other power sources](#)).



## ■ Opening the Menu Screen

1. Press  when the Home Screen is open.

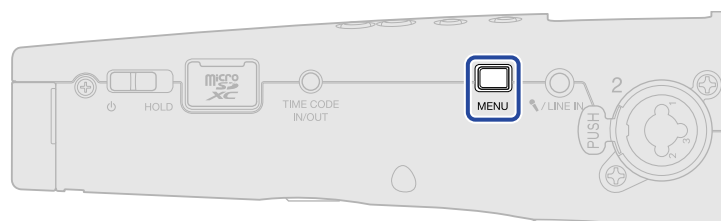

### HINT

When a screen other than the [Home Screen](#) is open, pressing  will open the Home Screen. This function is useful for returning quickly to the Home Screen from various setting screens. (Returning directly to the Home Screen is not possible from a few screens.)

# Recording process



---

Recording follows the process shown below.

## Preparation before recording

- Insert a microSD card (→ [Inserting microSD cards](#))
- Supply power (→ [Installing batteries](#), → [Connecting an AC adapter](#))
- Connect mics to the inputs, for example (→ [Connecting input devices](#))
- Turn the power on (→ [Turning the power on](#))
- Make settings related to input (→ [Making input settings](#))
- Make settings related to recording (→ [Making recording settings](#))

## Recording

- Use  to start recording and  to stop it (→ [Recording](#))

## Playing back and reviewing

- Use  to start playback and  to stop it (→ [Playing recordings](#))

# Making preparations

## Inserting microSD cards

1. When the power is off, open the microSD card slot cover, and insert a microSD card all the way into the slot with the pins facing up.

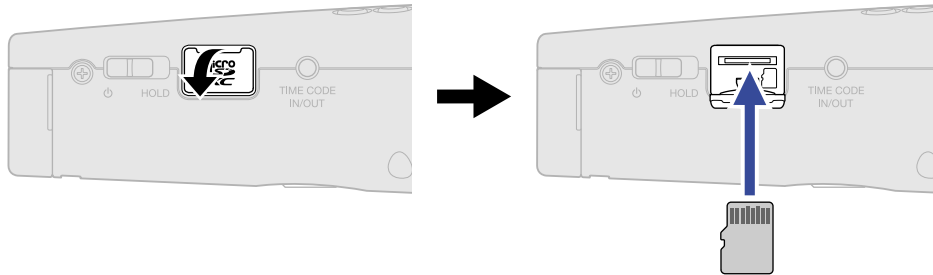

To remove a microSD card, push it further into the slot and then pull it out.

2. Close the microSD card slot cover.

### NOTE

- Always make certain that the power is off when inserting or removing a microSD card. Inserting or removing a card while the power is on could result in data loss.
- When inserting a microSD card, be sure to insert the correct end with the correct facing.
- Recording and playback are not possible when a microSD card is not loaded in the M4.
- Always format microSD cards in order to maximize their performance after purchasing them new or using them with a different device. (→ [Formatting microSD cards](#))
- The following types of recording media are supported.
  - microSDHC: 4 GB – 32 GB
  - microSDXC: 64 GB – 1 TB

# Supplying power

The M4 can be powered by batteries or a power supply connected to the USB port (AC adapter, USB bus power or portable battery).

When a power supply is connected to the USB port, it will be used before the batteries.

## Installing batteries

Use 4 AA batteries to power the M4 with batteries.

1. After turning the power off, loosen the battery compartment locking screw, and remove the battery case from the M4.

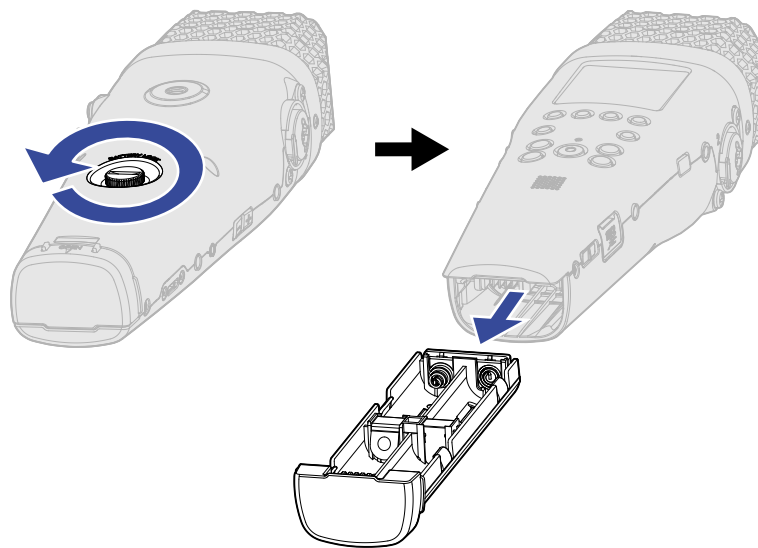

2. Put 4 AA batteries into the battery case.

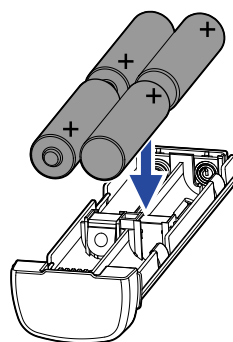

- 3.** Insert the battery case into the M4, and tighten the battery compartment locking screw.

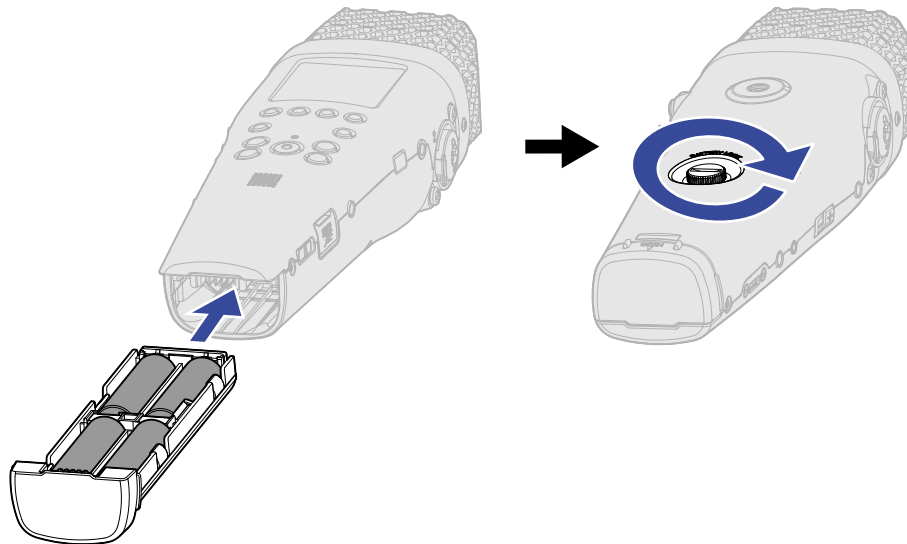

**NOTE**

- Use only one type of battery (alkaline, NiMH or lithium) at a time.
- Set the type of battery used correctly so that the amount of remaining battery charge can be shown accurately. (→ [Setting the type of batteries used](#))
- If the batteries run out of power, turn the power off immediately and install new batteries. The remaining battery power will usually be shown when using battery power (except for some screens).



# Connecting an AC adapter

Connect the cable of the dedicated AC adapter (AD-17) to the USB port (Type-C), and connect the adapter to an outlet.

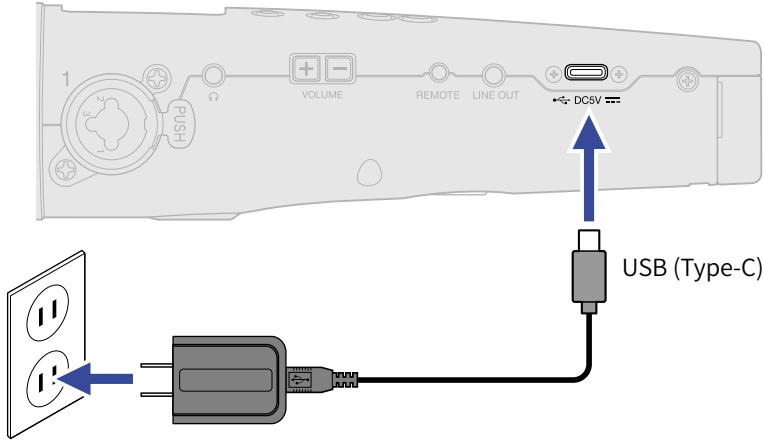

# Using other power sources

By connecting a computer to the USB port (Type-C), the M4 can be operated using USB bus power. In addition, a 5V portable battery (commercially-available) can also be used for power.

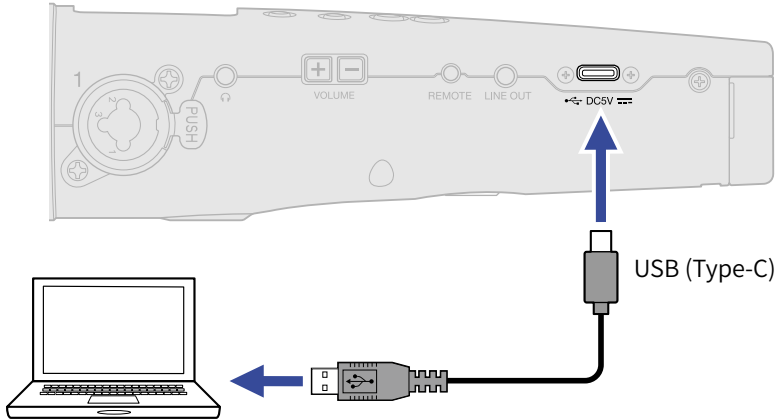

# Connecting input devices

## Using the built-in XY microphone

The M4 has 2 mic units in an inward-facing XY stereo arrangement.

By having the left and right diaphragms facing inward toward each other, a wide recording range can be covered while also clearly capturing sound in the center.

Furthermore, since the positions of sound capture are almost the same, phase differences between the left and right channels will not occur.

## Connecting mics and other devices to INPUT 1/2

In addition to input from the built-in XY mic, the M4 also has INPUT 1 and 2, along with a MIC/LINE IN jack that supports plug-in power, and is capable of recording up to 4 tracks total.

Mics, mixers and other devices can be connected to INPUT 1/2.

### ■ Connecting mics

Connect dynamic and condenser mics with XLR plugs to INPUT 1 and 2.

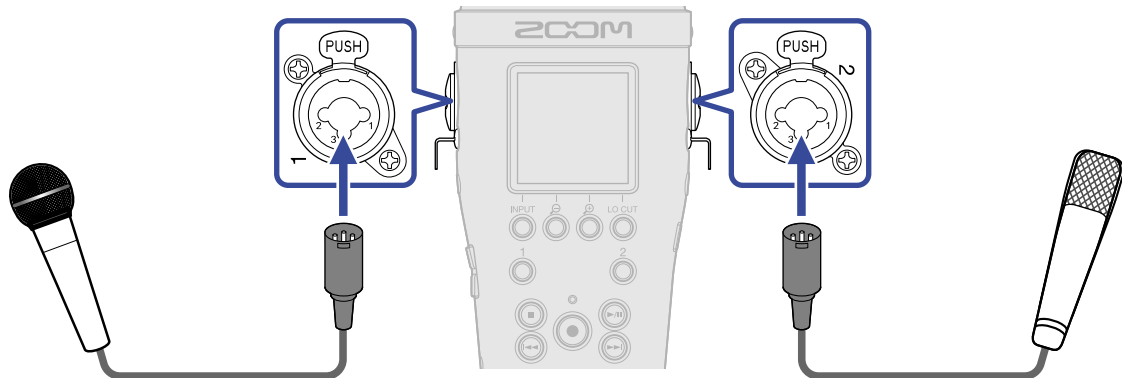

- When connecting a mic, set the input source to "MIC". (→ [Setting INPUT 1/2 sources, phantom power and stereo linking](#))
- Phantom power (+24 V/+48 V) can be supplied to condenser mics. (→ [Setting INPUT 1/2 sources, phantom power and stereo linking](#))
- When disconnecting a mic, pull the XLR plug while pushing the connector lock release button.

## ■ Connecting line level equipment

Connect mixers and other line level equipment with TRS plugs to INPUT 1 and 2.

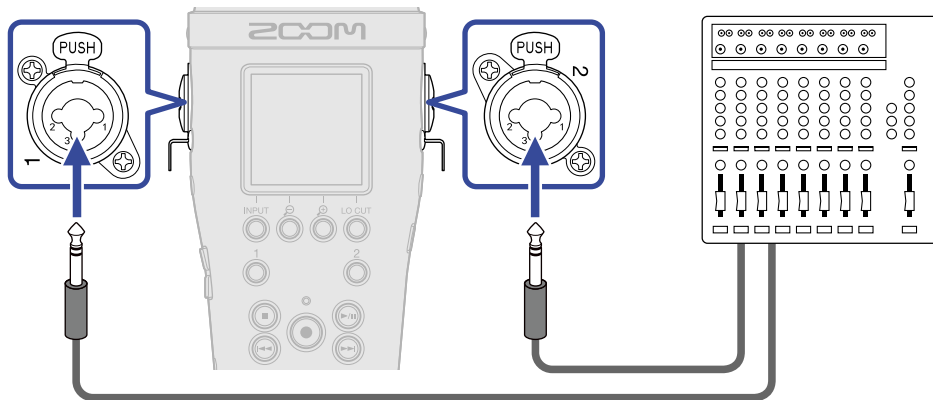

- When connecting line level equipment, set the input source to "LINE". (→ [Setting INPUT 1/2 sources, phantom power and stereo linking](#))
- Phantom power (+24 V/+48 V) can be supplied. (→ [Setting INPUT 1/2 sources, phantom power and stereo linking](#))
- Direct input of passive guitars and basses is not supported. Connect these instruments through a mixer or effects device.

## Connecting lavalier mics to the MIC/LINE IN jack

The M4 has a MIC/LINE IN jack that can be used to connect an external mic or line-level device.

Power can be supplied to mics that support plug-in power by setting Plugin Power to On. (→ [Using plugin power](#))

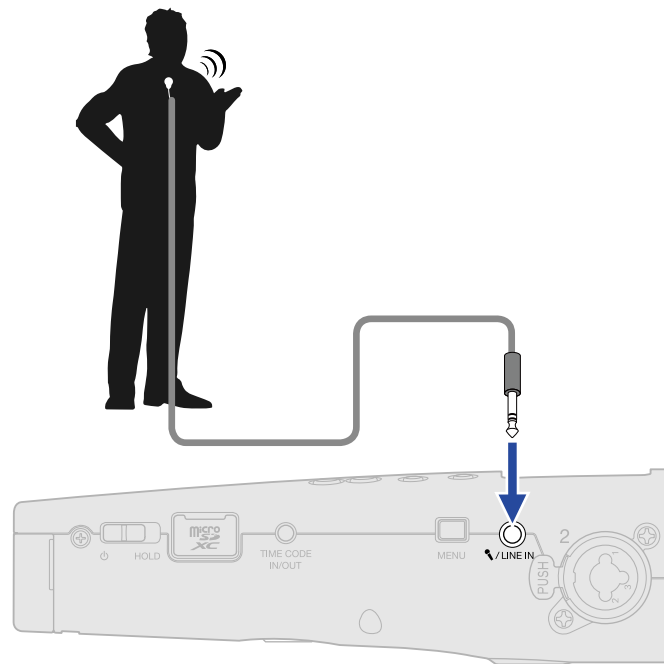

### NOTE

When using the MIC/LINE IN jack, the built-in XY mic cannot be used.

## Connection examples

---

The following kinds of recording are possible according to the situation.

### ■ Recording performances with a voice and instrument

Use the built-in XY mic to record the sound of playing an instrument, and use an external mic to record vocals.



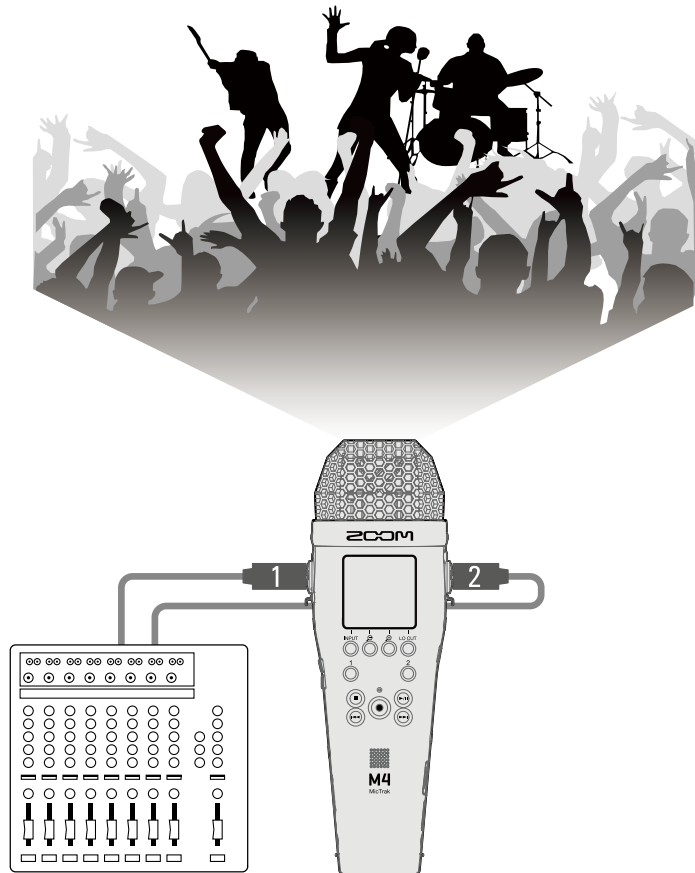

## ■ Concert recording

Use the built-in XY mic to record the sound of the performance and the audience, and record a stereo mix made on a mixer.



# Turning the power on/off

## Turning the power on

1. Slide  toward  until the display becomes active.

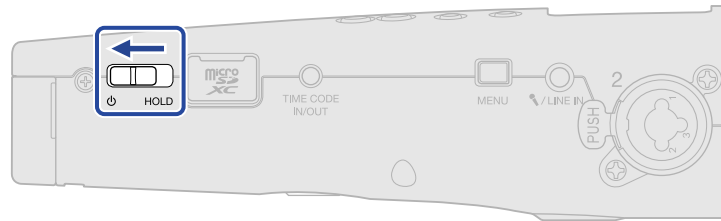

After the Startup Screen appears on the display, the Home Screen will be shown (→ [Home Screen](#)).

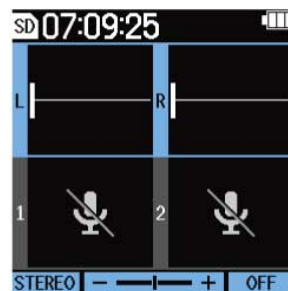



The first time the power is turned on immediately after purchase as well as after restoring the M4 to its factory default state, screens for setting the display language and date and time will appear on the display, so make these settings. (→ [Setting the language shown \(first time starting up\)](#), [Setting the date format \(first time starting up\)](#), [Setting the date and time \(first time starting up\)](#), [Setting the type of batteries used \(first time starting up\)](#))

### NOTE

- The M4 can be set to automatically turn off if it is not used for a specific amount of time. (→ [Setting the time until the power turns off automatically](#))
- If “No SD Card!” appears on the display, confirm that a microSD card is inserted properly. (→ [Inserting microSD cards](#))
- If “Invalid SD Card!” appears on the display, the card is not formatted correctly. Format the microSD card or use a different microSD card. (→ [Formatting microSD cards](#), [Inserting microSD cards](#))

## Turning the power off

1. Slide  toward  until “Saving data” appears on the display.

The display will become empty and the power will turn off.

### NOTE

While “Saving data” is being shown, the current settings of the M4 are being saved.  
Do not disconnect the AC adapter or remove the batteries while “Saving data” is being shown.

## Setting the language shown (first time starting up)

The first time you turn the power on after purchase, set the display language when the Language Setting Screen opens.

1. Use  and  to select the display language, and press  to confirm.



This will confirm the language shown on the display, and open a screen to set the date format, so set the format. (→ [Setting the date format \(first time starting up\)](#))

---

### HINT

The display language setting can also be changed later from the Menu Screen. (→ [Setting the language shown](#))



---



## Setting the date format (first time starting up)

The first time you turn the power on after purchase, after setting the display language, the date format settings screen will be shown on the display, so set it.

The date written in recording files will be in the format selected here.

1. Use  and  to select the date format, and press  to confirm.

The current set date will be shown at the bottom of the screen as a concrete example of the date format set.

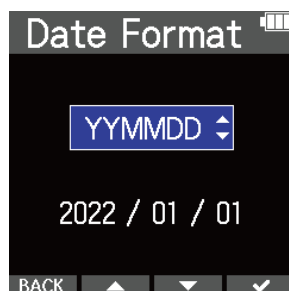

Setting	Explanation
YYMMDD	The date is shown in year, month, day order.
MMDDYY	The date is shown in month, day, year order.
DDMMYY	The data shown in day, month, year order.



After setting the date format, a screen to set the date and time will open, so set the date and time. (→ [Setting the date and time \(first time starting up\)](#))

### HINT



The Date Format setting can also be changed later from the Menu Screen. (→ [Setting the date format](#))

# Setting the date and time (first time starting up)

The first time you turn the power on after purchase, after setting the date format, the date and time settings screen will be shown on the display, so set them. The date and time are written to recording files.

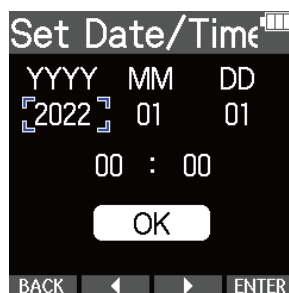
1. Use  and  to select the item to set, and press  to confirm.



2. Use  and  to change the value, and press  to confirm.



3. Repeat steps 1-2 to set the date and time.

4. After setting all items, use  and  to select , and press  to confirm.

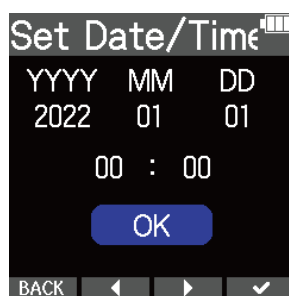

After confirming the date and time, a screen to set the battery type will open, so set it. (→ [Setting the type of batteries used \(first time starting up\)](#))

## NOTE



If power is not supplied for a long time, the date and time settings stored in the mic will be reset. If the Set Date/Time Screen appears during startup, set them again.

## HINT

The date and time setting can also be changed later from the Menu Screen. (→ [Setting the date and time](#))

## Setting the type of batteries used (first time starting up)

The first time you turn the power on after purchase, after setting the date and time, the battery type setting screen will be shown on the display. Select correctly the type of batteries used in the M4 so that the remaining battery charge can be shown accurately on the display.

1. Use  and  to select the battery type, and press  to confirm.

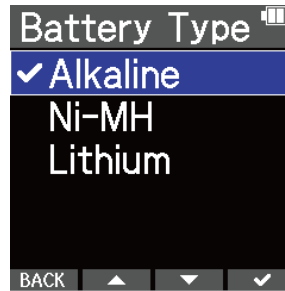

Setting	Explanation
Alkaline	Alkaline batteries
Ni-MH	Nickel-metal hydride batteries
Lithium	Lithium batteries

### HINT

The battery type setting can also be changed later from the Menu Screen. (→ [Setting the type of batteries used](#))

## Preventing misoperation (hold function)

In order to prevent misoperation, the hold function can be used to disable the buttons on the M4.

1. Slide  toward HOLD.

This turns on the hold function, disabling all button operations.

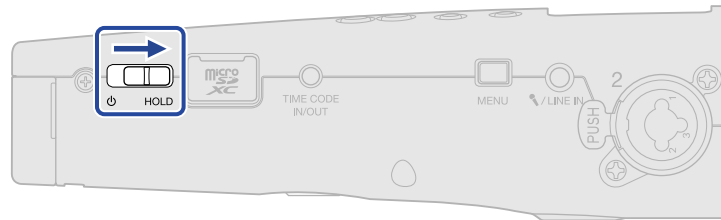

To disable the hold function, slide  back to the center position.

# Making input settings



## Selecting inputs for making settings

Settings can be made separately for each input. On the Home Screen, select the input to set: the built-in XY mic, INPUT 1 or INPUT 2.

### Selecting the built-in XY mic

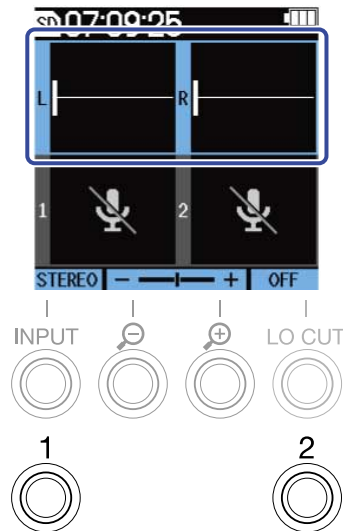
Press  or  to select the built-in XY mic.



Pressing  (or ) will switch between the built-in XY mic and INPUT 1 (or INPUT 2).

When the M4 power is turned on, the Home Screen will open with the built-in XY mic selected.

The following parameters can be set for the built-in XY mic.

Item	Explanation
On/Off	This turns the input on/off. (→ <a href="#">Changing the audio format used for input from the built-in XY mic</a> )
Recording audio format	This sets the audio format used to record files. (→ <a href="#">Changing the audio format used for input from the built-in XY mic</a> )
LO CUT	Low frequencies can be cut to reduce the sound of wind and vocal pop noises, for example. (→ <a href="#">Reducing noise (low-frequency cut)</a> )

## Selecting INPUT 1

Press **1** to select INPUT 1.

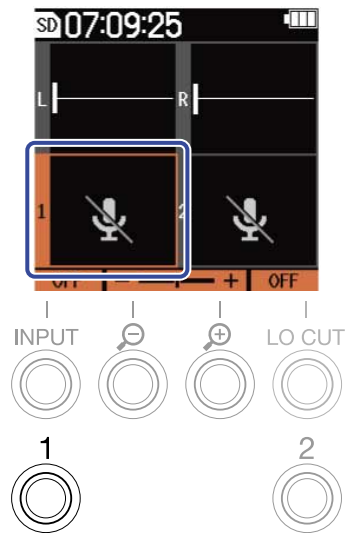

Pressing **1** will switch between the built-in XY mic and INPUT 1.

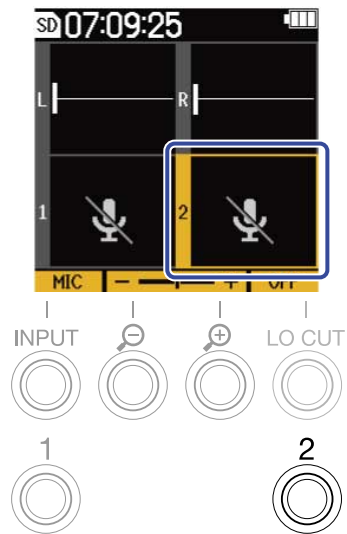

## Selecting INPUT 2

Press **2** to select INPUT 2.





Pressing **2** will switch between the built-in XY mic and INPUT 2.

## Selecting INPUT 1 and 2 (when stereo-linked)

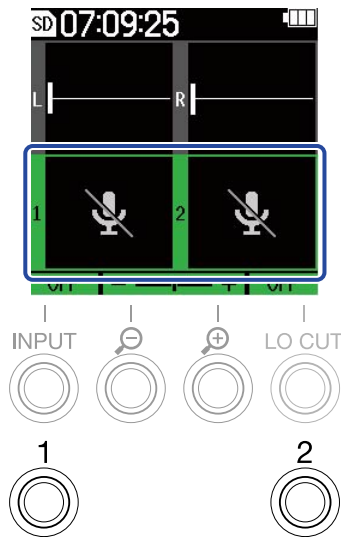
Press  or  to select INPUT 1 and 2.



Pressing  or  will switch between the built-in XY mic and INPUT 1 and 2.

The following parameters can be set for INPUT 1 and INPUT 2.

Item	Explanation
On/Off	This turns the input on/off. (→ <a href="#">Setting INPUT 1/2 sources, phantom power and stereo linking</a> )
Source	Use this to set the INPUT 1/2 source type and turn phantom power on/off. (→ <a href="#">Setting INPUT 1/2 sources, phantom power and stereo linking</a> )
Phantom power	This turns phantom power on/off. (→ <a href="#">Setting INPUT 1/2 sources, phantom power and stereo linking</a> )
Stereo linking	Sound from INPUT 1 and 2 can be handled as stereo audio. (→ <a href="#">Setting INPUT 1/2 sources, phantom power and stereo linking</a> )  This function was added in firmware version 1.10. (→ <a href="#">Checking firmware versions</a> 、 <a href="#">Updating the firmware</a> )
LO CUT	Low frequencies can be cut to reduce the sound of wind and vocal pop noises, for example. (→ <a href="#">Reducing noise (low-frequency cut)</a> )

# Changing the audio format used for input from the built-in XY mic

The audio format used for input from the built-in XY mic can be selected.

When set to STEREO, left and right channels will be input together as stereo audio. When set to MONO, left and right channels will be mixed together and input as mono audio.

When set to OFF, sound from the built-in XY mic will not be input.

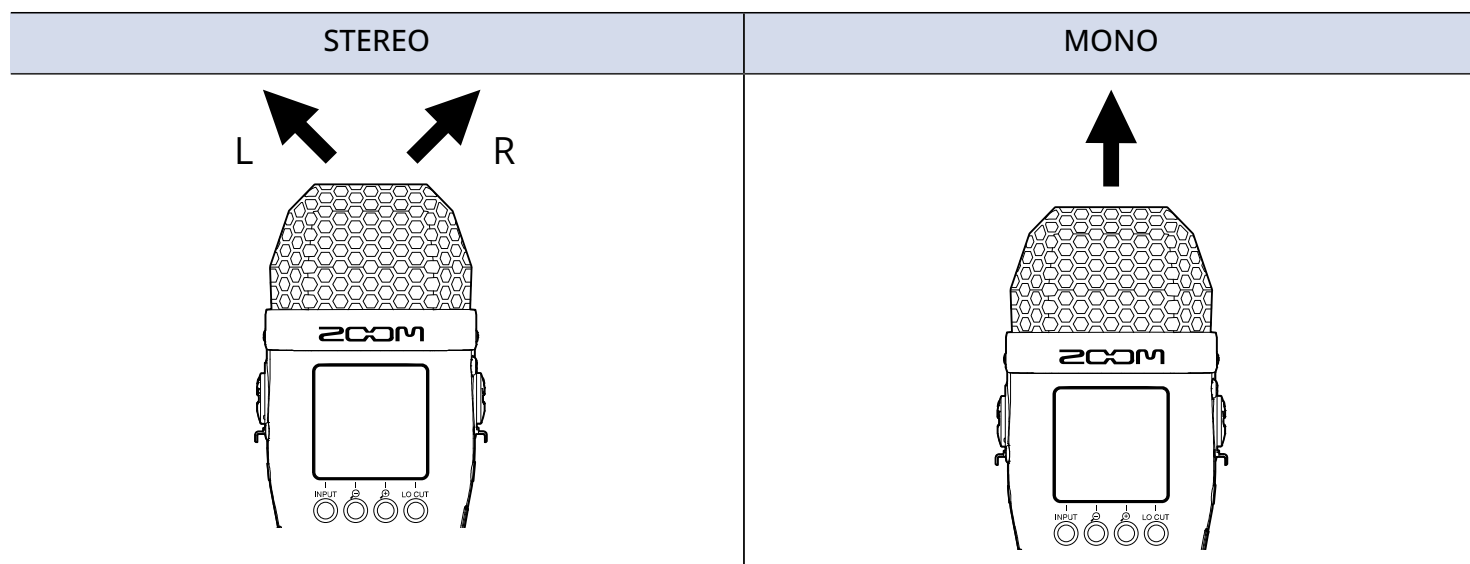

**1.** On the Home Screen, select the built-in XY mic. (→ [Selecting inputs for making settings](#))

**2.** Press **INPUT** repeatedly to select the setting.

The name of the selected setting is shown on the display.

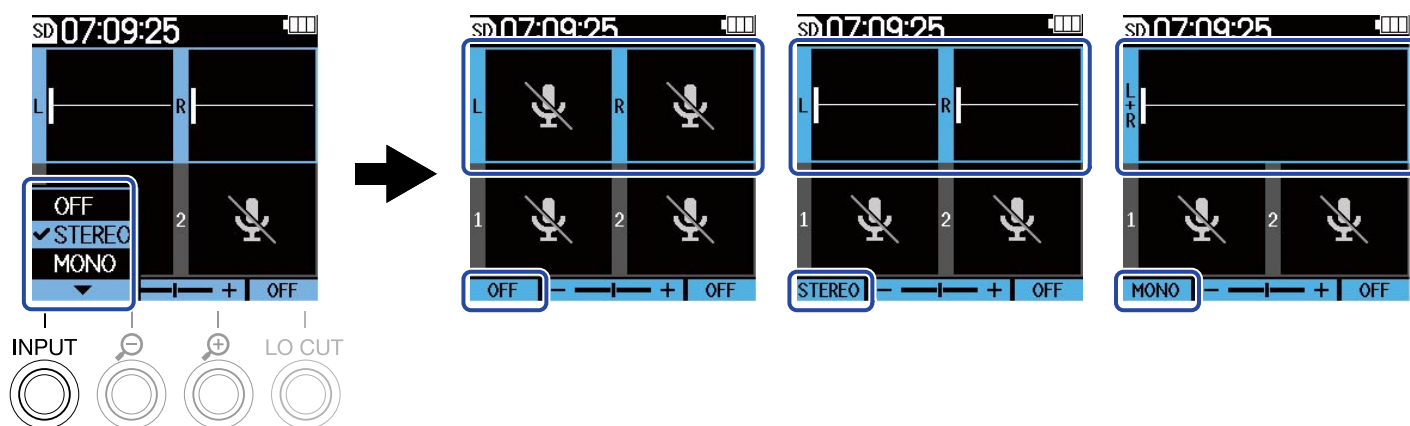

## NOTE

The recording file format will be changed in the same manner. (→ [Folder and file structure](#))



---

**HINT**

- The left and right channels can also be switched for the audio input by the built-in XY mic. (→ [Switching the left and right audio signals input from the built-in XY mic](#))
-

# Setting INPUT 1/2 sources, phantom power and stereo linking

INPUT 1 and 2 can be selected and enabled as inputs to use. Enabled inputs are armed for recording and their signals are output from the headphone and LINE OUT jacks.

1. Select the input to set on the Home Screen. (→ [Selecting inputs for making settings](#))

2. Press **INPUT** repeatedly to select the setting.

The name of the selected setting is shown on the display.

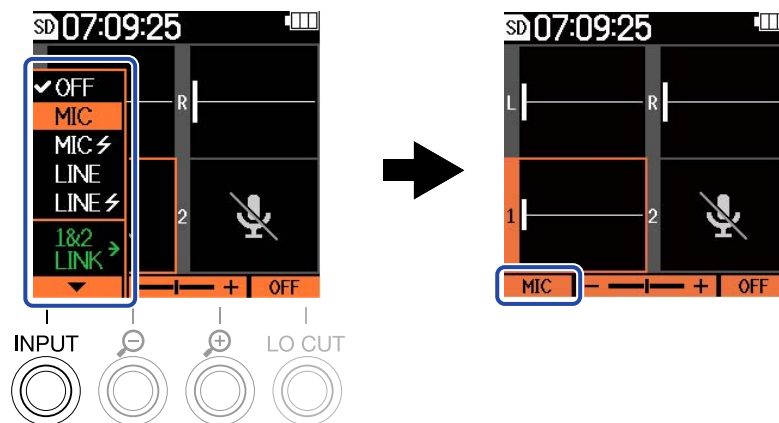

Setting	Explanation
OFF	Use when not connecting any equipment. Inputs set to OFF will not be recorded.
MIC	Use when connecting a mic or other equipment with a low input level.
MIC ⚡	Use when connecting equipment with mic level input that requires phantom power.
LINE	Use when connecting line level equipment. The input level will be reduced 20 dB compared to when "MIC" or "MIC ⚡" is selected.
LINE ⚡	Use when connecting equipment with line level input that requires phantom power.
1&2 LINK	This sets the stereo linking of INPUT 1 and 2.  This function was added in firmware version 1.10. (→ <a href="#">Checking firmware versions</a> 、 <a href="#">Updating the firmware</a> )

When an input is set to "OFF", its volume will stop being shown on the Home Screen.  
Example: Input 2 set to "OFF"

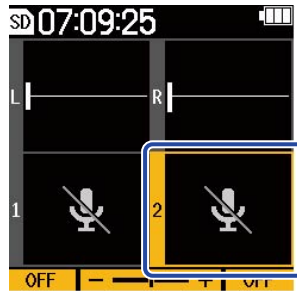

#### NOTE

- When equipment that does not support phantom power is connected, do not use the "MIC ⚡" or "LINE ⚡" settings. Doing so could damage the device.
- Inputs set to "OFF" will not be recorded and their sounds will not be output from the headphone and LINE OUT jacks.
- Setting stereo linking will also change the monitored sound. Input from INPUT 1 will become the left (L) channel and input from INPUT 2 will become the right (R) channel.
- When stereo linking is set, the following parameters related to input from INPUT 1 and INPUT 2 will be shared by both.
  - Input source selection and phantom power on/off setting (→ [Setting INPUT 1/2 sources, phantom power and stereo linking](#))
  - Low-cut frequency (→ [Reducing noise \(low-frequency cut\)](#))
  - Volume amplification on the display (→ [Adjusting the volume display size to make checking easier](#))

#### HINT

- The battery operation time can be lengthened by setting inputs not being used to OFF.
- The voltage for phantom power can be set to +24 V or +48 V. (→ [Changing phantom power voltage](#))

# Reducing noise (low-frequency cut)

Low frequencies can be cut to reduce the sound of wind and vocal pop noises, for example.

1. Select the input to set on the Home Screen. (→ [Selecting inputs for making settings](#))
2. Press **LO CUT** repeatedly to set the cutoff frequency.  
The selected frequency is shown on the Home Screen.

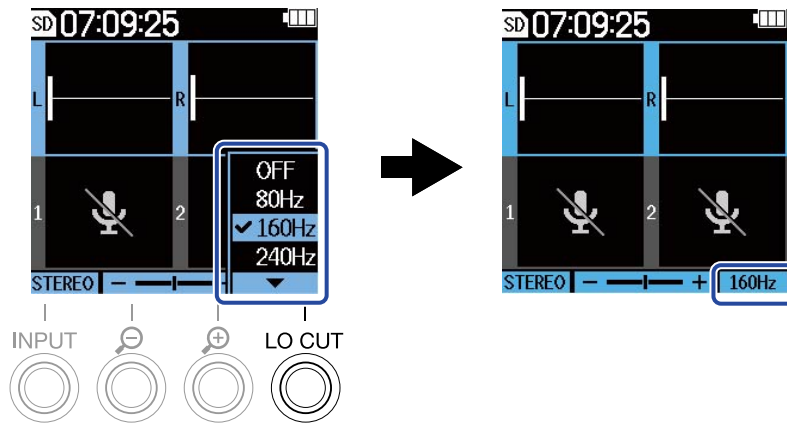

LO CUT can be set to OFF, 80Hz, 160Hz or 240Hz.

## NOTE

When INPUT 1 and 2 are stereo linked, the same cut frequency is used for both.

## HINT

We recommend using a windscreen (included) if air is blown directly at the mic, for example, when recording outdoors or when the mic is near the mouth of a speaker.

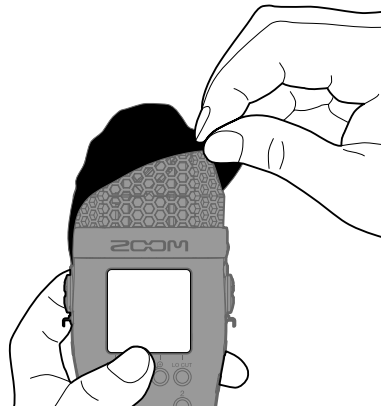



# Changing phantom power voltage

The voltage for phantom power can be set to +24 V or +48 V.



The selected voltage will be applied to both INPUT 1 and INPUT 2.

1. Press  when the Home Screen is open.

This opens the Menu Screen.

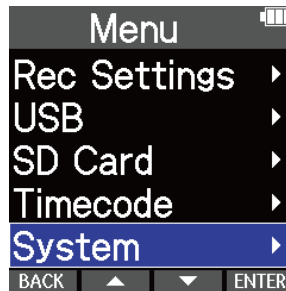
2. Use  and  to select "System" and press  to confirm.





3. Use  and  to select "Power" and press  to confirm.



4. Use  and  to select "Phantom Volt." and press  to confirm.



5. Use  and  to select the voltage, and press  to confirm.

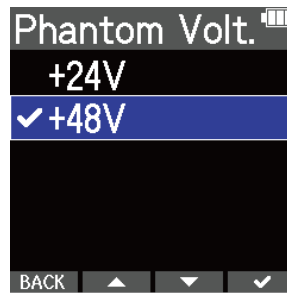

---



#### HINT

- When using mics that can operate with +24 V phantom power, setting the phantom voltage to +24 V can increase battery operation time.
-



# Using plugin power

Make the following setting when a mic that is compatible with plug-in power is connected to the MIC/LINE IN jack.

1. Press  when the Home Screen is open.  
This opens the Menu Screen.

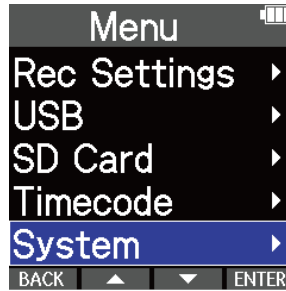
2. Use  and  to select "System" and press  to confirm.



3. Use  and  to select "Power" and press  to confirm.



4. Use  and  to select "Plugin Power" and press  to confirm.

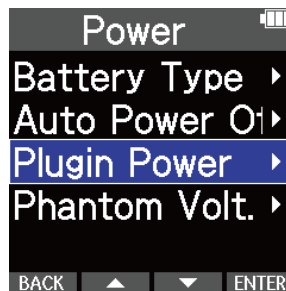

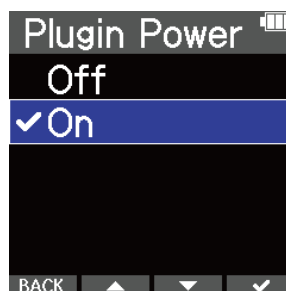

5. Use  and  to select "On" and press  to confirm.



# Switching the left and right audio signals input from the built-in XY mic

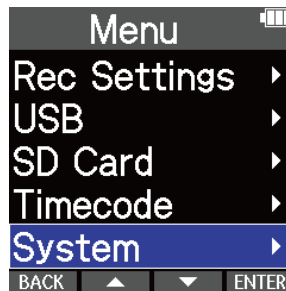

1. Press  when the Home Screen is open.  
This opens the Menu Screen.

2. Use  and  to select "System" and press  to confirm.



3. Use  /  to select "MIC L/R Swap", and press  to confirm.



4. Use  /  to select "On", and press  to confirm.

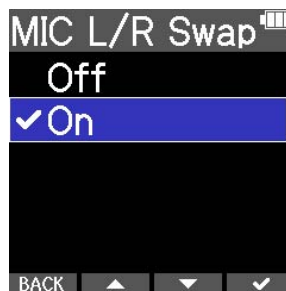

## NOTE

- This only switches the left and right signals for the built-in XY mic. This does not switch input to the MIC/LINE IN jack.
- This function was added in firmware version 1.10. (→ [Checking firmware versions](#)、[Updating the firmware](#))



# Making output settings

## Adjusting the line output level

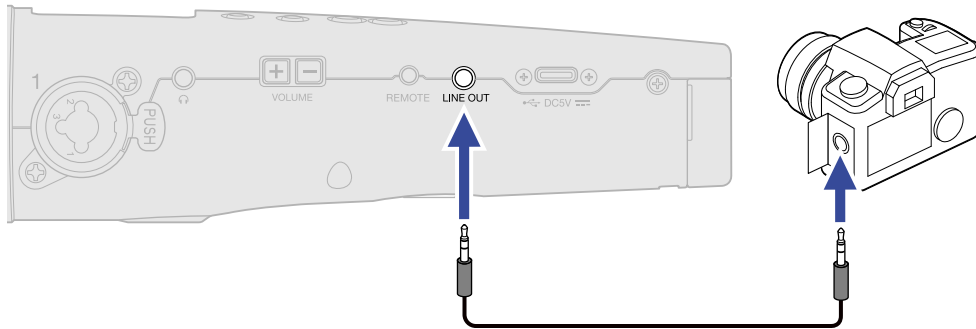

The line level output to other devices can be adjusted.

1. Minimize the input gain of the other device.
2. Use an audio cable to connect the external mic jack of the other device with the M4 LINE OUT jack.



### HINT

When output to another device is not necessary, the battery operation time can be lengthened by removing the connection cable from the LINE OUT jack.

3. Use  and  to adjust the line output level. Then, press  to close the adjustment screen.

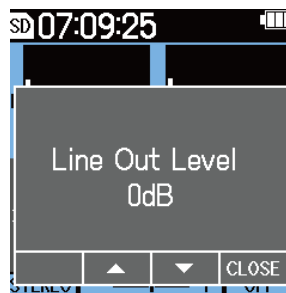

### NOTE

- See the manual of the connected device for information about its operation.
- If the automatic gain control function on the other device is on, turn it off.

### HINT

- This can be set to Mute or from -48 to +24 dB.
- When "Mute" is selected, output from the LINE OUT jack will be muted.

# Recording



## Adjusting the volume display size to make checking easier

The M4 records using 32-bit float format, making input gain adjustments unnecessary. Depending on the input signal, however, the volume shown on the display could be too small or too large, making it difficult to check.

By changing volume amplifications shown on the display, sizes can be adjusted to make each input easy to check.

Moreover, the sizes of waveforms shown during recording also change recorded volumes.

**1.** On the Home Screen, select the input for changing volume amplification. (→ [Selecting inputs for making settings](#))

**2.** Use  and  to adjust the size to make the volume easy to check.

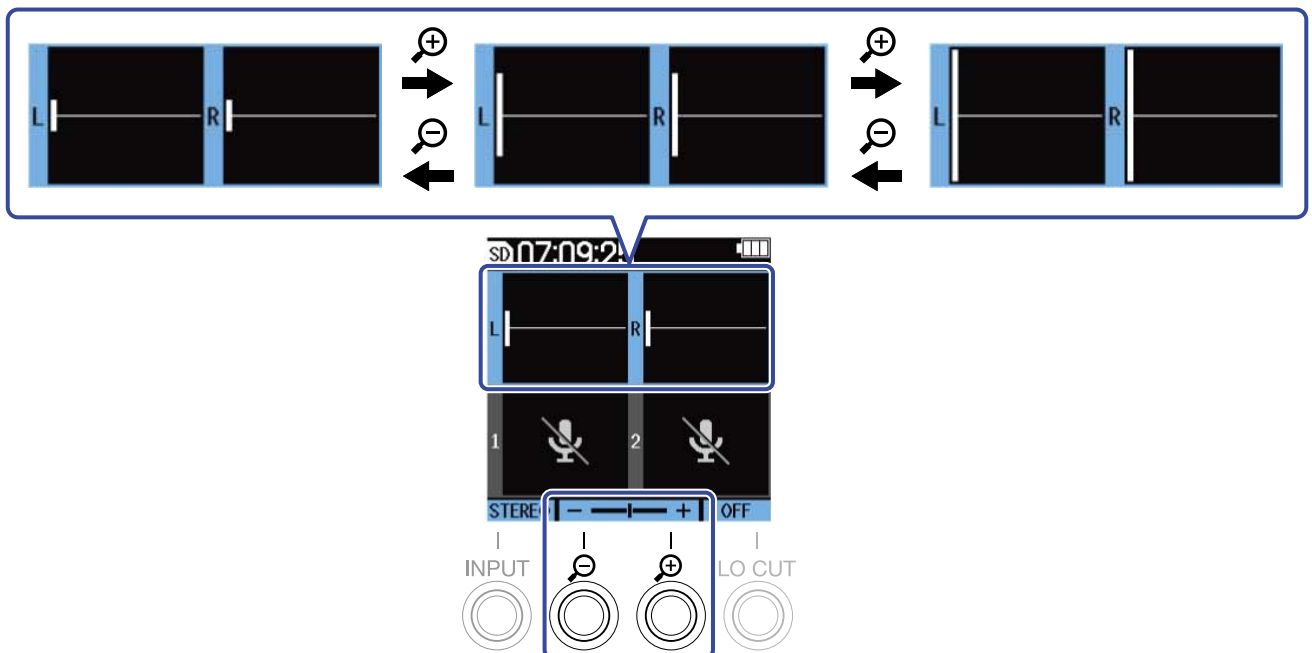

The amplification can be checked with  below the volume display.

### NOTE

- The volume display size can be adjusted to 31 levels.
- Be careful with the volume if you are monitoring the input sound with headphones, for example.
- Adjusting the amplification during recording will not affect the recording level of that recording.
- When INPUT 1 and 2 are stereo linked, the same volume amplification on the display is used by both.

# Monitoring input and playback sounds

Input and playback sounds can be monitored using headphones, for example, and the monitoring volume can be adjusted.

1. Connect headphones, for example, to the headphone jack.

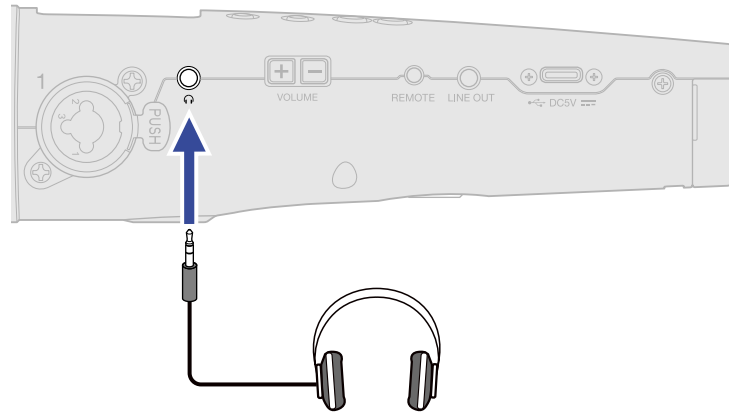

2. Use  to adjust the volume of the headphones or other connected device.

The volume will be shown on the display while it is being adjusted.

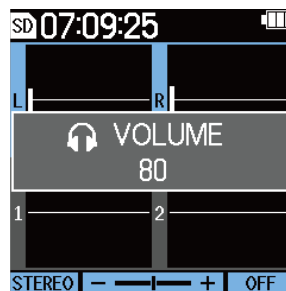

## NOTE

- The volume output from the headphone jack will be affected by changing the volume amplification on the display. (→ [Adjusting the volume display size to make checking easier](#))
- When nothing is connected to the headphone jack, using  will change the volume of the built-in speaker.
- The built-in speaker cannot be used for monitoring while recording.

## HINT

- Adjust the headphone volume after adjusting the input volume amplification on the display. (→ [Adjusting the volume display size to make checking easier](#))
- Battery operation time can be lengthened by disconnecting headphones from the headphone jack when headphone monitoring is not needed.
- The volume can be adjusted separately for the built-in speaker and headphones.

# Making recording settings

## Setting the sample rate

The sampling rate used to record files can be set.

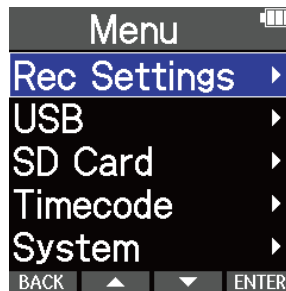

1. Press  when the Home Screen is open.  
This opens the Menu Screen.

2. Use  and  to select "Rec Settings" and press  to confirm.

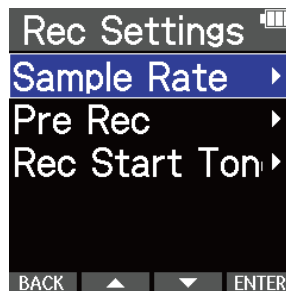

3. Use  and  to select "Sample Rate" and press  to confirm.



4. Use  and  to select the sample rate and press  to confirm.

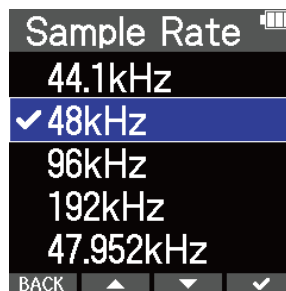

The following sample rates can be selected.

44.1kHz, 48kHz, 96kHz, 192kHz, 47.952kHz, 48.048kHz

### NOTE

The bit depth used for recording is always 32-bit float.

## Capturing audio before recording starts (pre-recording)

---



The input signal is always buffered for a set amount of time, so it can be captured for up to 6 seconds before  is used to start recording (pre-recording).

This is useful when  is used late, for example.

1. Press  when the Home Screen is open.  
This opens the Menu Screen.

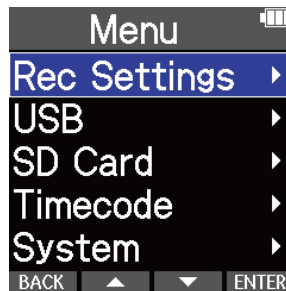
2. Use  and  to select "Rec Settings" and press  to confirm.



3. Use  and  to select "Pre Rec" and press  to confirm.

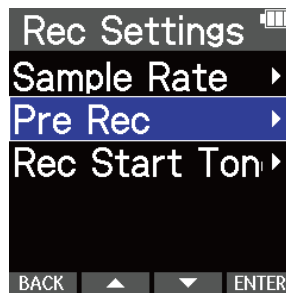

4. Use  and  to select "On" and press  to confirm.

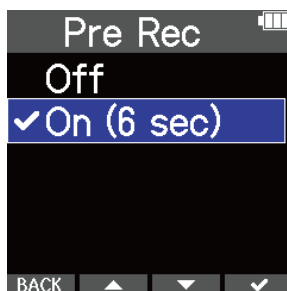

The pre-recording time when set to "On" depends on the sample rate setting (→ [Setting the sample rate](#)).

Sample Rate	Pre-recording time
44.1 kHz	6 seconds
48 kHz	6 seconds
47.952 kHz	6 seconds
48.048 kHz	6 seconds
96 kHz	3 seconds
192 kHz	1 second

## Enabling the recording start tone

Half-second tone signals (recording start tones) can be output from the output jacks (headphone and LINE OUT) when recording starts.

Since recording start tones are also written to recording files, when recording audio for video with the M4, sending its output signal to the camera input can make synchronizing audio and video easier.

1. Press  when the Home Screen is open.  
This opens the Menu Screen.

2. Use  and  to select "Rec Settings" and press  to confirm.



3. Use  and  to select "Rec Start Tone" and press  to confirm.

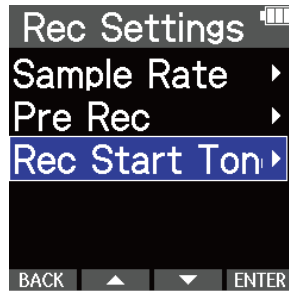

4. Use  and  to select "On" and press  to confirm.

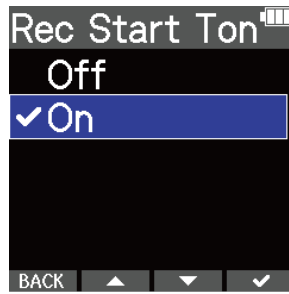

5. Use a stereo minijack cable to connect the camera input jack and the M4 LINE OUT jack.

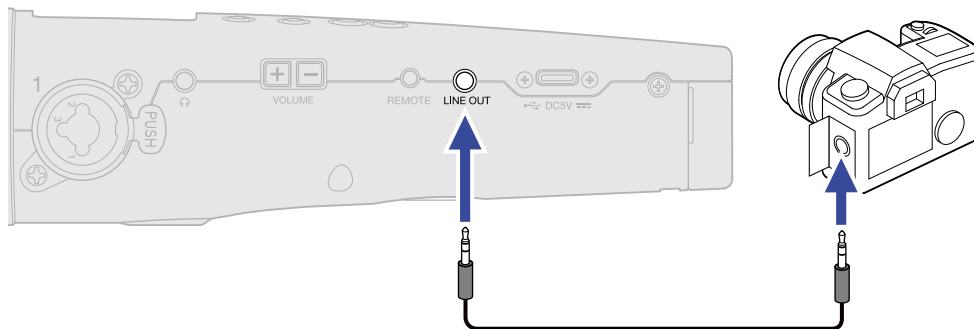

**NOTE**

Be careful with the volume if you are monitoring the input sound with headphones, for example.

# Recording

1. Press  when the Home Screen is open.



The REC indicator will light red, recording will start and the name of the file being recorded will be shown on the display.

The elapsed recording time is shown while recording.

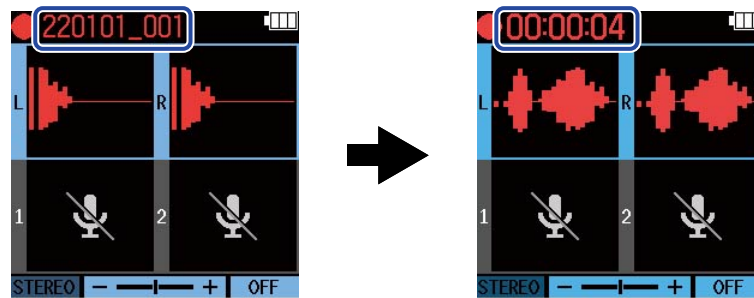

2. Press  to stop.

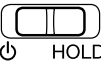
Sliding  toward HOLD can prevent misoperation when recording. (→ [Preventing misoperation \(hold function\)](#))

## NOTE

If the file size exceeds 2 GB when recording, a new file will be created automatically and recording will continue without pause. No gap in sound will occur between the two files when this happens.

## HINT

- Marks can be added during recording by pressing . (→ [Adding marks during recording](#))  
A maximum of 99 marks can be added in a file.
- Files are automatically saved at set intervals while recording. If the power is interrupted or another problem occurs while recording, an affected file can be restored to normal by playing it with the M4.



## Adding marks during recording

Marks can be added to a file while it is being recorded.

Added marks are shown on the [Playback Screen](#) where ⏮ and ⏭ can be used to move the playback position between them.

**1.** Press  while recording.

This adds a mark at the position of the current elapsed recording time.

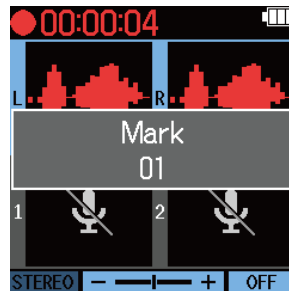



### NOTE

- Up to 99 marks can be added to a single file.
- Marks can be deleted on the [Playback Screen](#). (→ [Deleting marks](#))

# Playing recordings

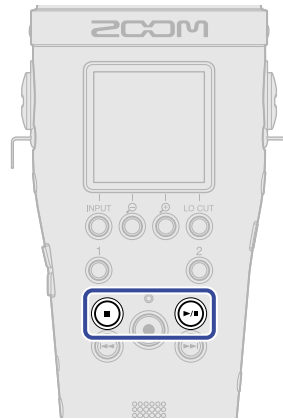
## Playing recordings



1. Press  when the Home Screen is open.

This opens the [Playback Screen](#) on the display and starts playback.

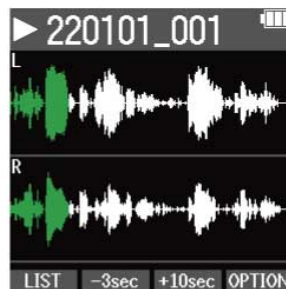

See "[Playback Screen operations](#)" for details about operations when the Playback Screen is open.

### NOTE

- The M4 cannot play files that it did not record or files that have been edited elsewhere after recording.
- On the Playback Screen, all files in a TAKE folder are treated as a single file. For example, if two files named "220101\_001\_Tr1.WAV" and "220101\_001\_Tr2.WAV" have been created in the TAKE folder, a single file named "220101\_001" will be shown on the FILE LIST Screen. If this file is selected and an operation, including deletion, normalization or bit depth conversion, is conducted on it, that operation will be applied to all the files in its TAKE folder. (→ [M4 folder and file structure](#))

### HINT





Use the FILE LIST Screen to select files for playback. (→ [Checking files \(FILE LIST Screen\)](#))

2. Press .

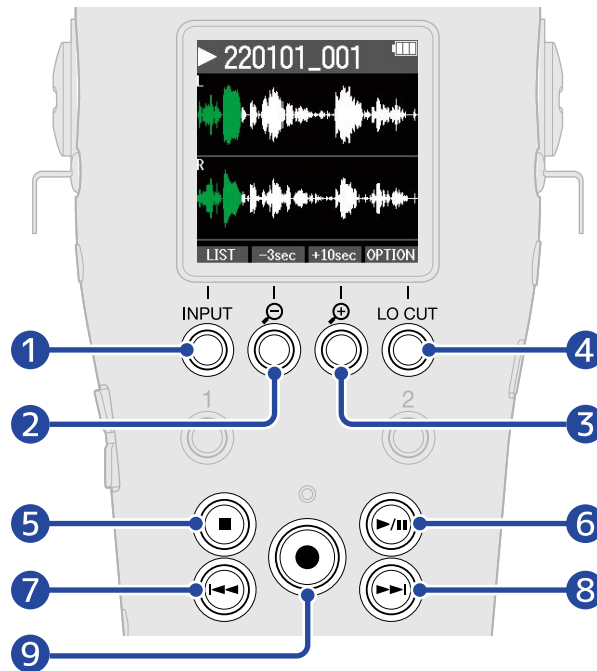
This stops playback and reopens the Home Screen.

# Playback Screen operations



- 1** **LIST**  
This opens the [FILE LIST Screen](#).
- 2** **-3sec**  
This moves the playback position 3 seconds backward.
- 3** **+10sec**  
This moves the playback position 10 seconds forward.
- 4** **OPTION**  
This opens the file options, which include operations explained in the following sections: [Optimizing file volume \(normalization\)](#), [Changing bit depth and exporting files \(Export\)](#), [Checking file information](#), and [Deleting files](#).
- 5**   
This stops playback and reopens the Home Screen.
- 6**   
This pauses and resumes playback.
- 7**   
This moves to the beginning of the file or the previous mark or plays the previous file.  
Press and hold to search backward in the file.
- 8**   
This moves to the next mark or plays the next file.  
Press and hold to search forward in the file.



9



This adds a mark at the current playback position. If there is already a mark at the current playback position, that mark will be deleted. (→ [Adding/deleting marks during playback](#))

# Adding/deleting marks during playback

Marks can be added to a file while it is being played.

Added marks are shown on the Playback Screen where  and  can be used to move the playback position between them.

## Adding marks



---

1. When the [Playback Screen](#) is open, press  to add a mark at the desired playback position.

A mark will be added at the playback position when  is pressed.

## Deleting marks

---

1. When paused on the [Playback Screen](#), use  and  to move to the playback position with the mark to be deleted.



2. Press .

The mark at that playback position will be deleted.

# Using automatic playback volume adjustment

By setting "Auto Play Vol" to "On", the playback volume can be made even regardless of the recording level loudness.

1. Press  when the Home Screen is open.  
This opens the Menu Screen.

2. Use  and  to select "System" and press  to confirm.

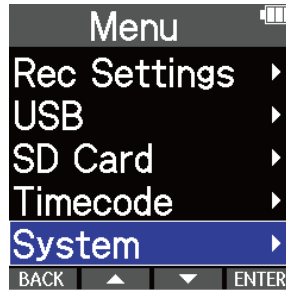

3. Use  and  to select "Auto Play Vol" and press  to confirm.



4. Use  and  to select "On" and press  to confirm.

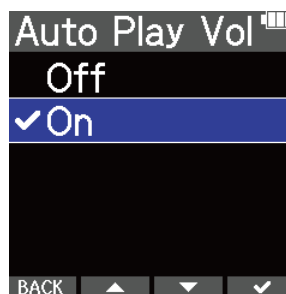

When "Auto Play Vol" is set to "On",  will appear at the top right of the Playback Screen.



# Managing files

Files created by the M4 are saved on the microSD card.

Recording files on the microSD card can be selected. Then, they can be normalized and have their bit depths converted as well as be deleted.

## M4 folder and file structure

### Folder and file structure

When recording with the M4, files are created on microSD cards in the following manner.

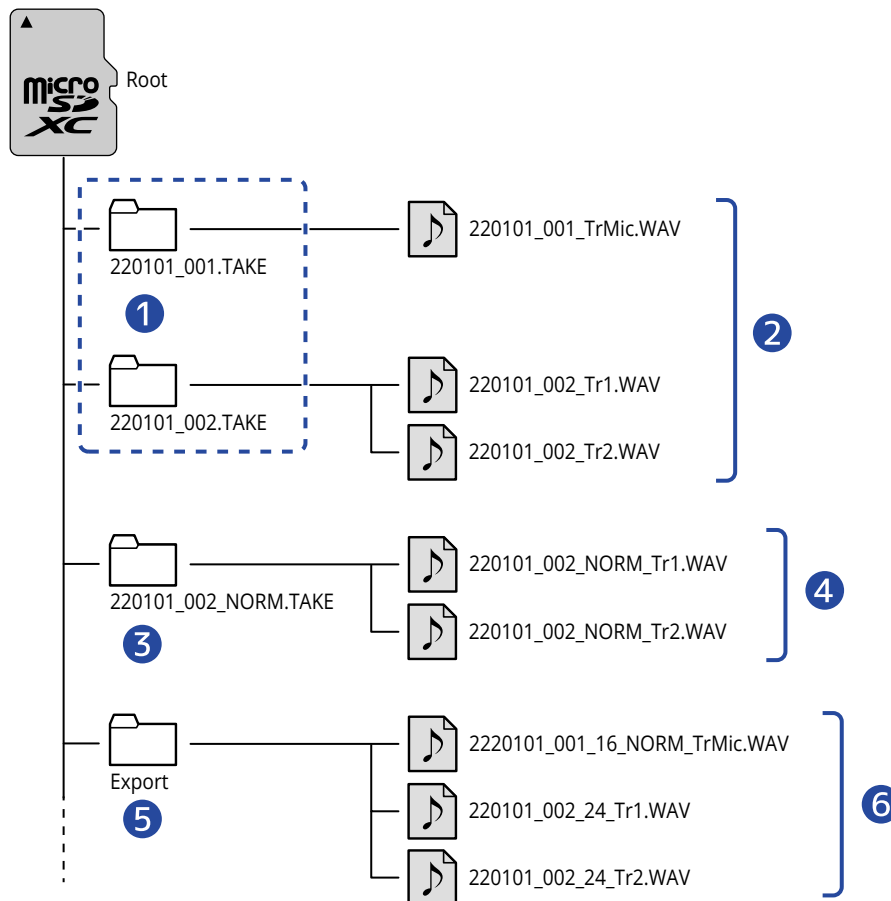

#### 1 TAKE folders

These are created each time recording is conducted. TAKE folders are named with this format: “date\_take number.TAKE”.

These folders store the mono and stereo files created.

#### 2 Recording files

Files recorded by the M4 are saved in TAKE folders on the microSD card.

See “[Recording file naming](#)” for details about recording file names.

- Stereo files will be created when the input format for the built-in XY mic is “STEREO” or when INPUT 1 and 2 are stereo linked. Mono files will be created in other cases. (→ [Changing the audio format used for input from the built-in XY mic](#), [Setting INPUT 1/2 sources, phantom power and stereo linking](#))

### 3 Normalization folder

This is created when files are normalized. Files created by normalization are saved in these folders. (→ [Optimizing file volume \(normalization\)](#))

Folders are named “XX\_NORM.TAKE”.

- XX: The name before “.TAKE” of the TAKE folder with the file that was normalized.

### 4 Normalized files

These files have been processed with normalization. (→ [Optimizing file volume \(normalization\)](#))

### 5 Export folder

This is created when files are exported. Files produced by exporting are saved in the Export folder. (→ [Changing bit depth and exporting files \(Export\)](#))

### 6 Export files

Files created by conducting file export are saved in the Export folder. (→ [Changing bit depth and exporting files \(Export\)](#))



# Recording file naming

File names are assigned in the following format.

File name example	Explanation
<p>20220101_001_Tr1.WAV</p> <p>1      2      3</p>	<ol style="list-style-type: none"><li><b>1 Date</b> The set date is used.</li><li><b>2 Take number</b> This number is increased by one every time recording is started anew. In addition, if the file size exceeds 2 GB when recording for a long time, the new file that is created will also be numbered one higher.</li><li><b>3 Track name</b> This shows the track used for recording.</li></ol>

## NOTE

- If the file size exceeds 2 GB, a new file and TAKE folder will be created automatically and recording will continue without pause. When this happens, the take number for the newly created file and TAKE folder will be increased by one.
- Files created through normalization will be named "XX\_NORM\_track name.WAV" and saved in normalization folders. ([Changing bit depth and exporting files \(Export\)](#))
  - XX: The name before ".TAKE" of the TAKE folder with the file that was normalized.
- Files created by exporting will be saved in the Export folder using the name "XX\_YY\_ZZ\_track name.wav". ([Changing bit depth and exporting files \(Export\)](#))
  - XX: Name before ".TAKE" of TAKE folder with the exported file
  - YY: bit depth (16/24)
  - ZZ: normalize setting ("NORM" when on or nothing when off)
- The M4 cannot play files in the Export folder.

## Checking files (FILE LIST Screen)

Use the [FILE LIST Screen](#) to check files on the microSD card. Files can also be played and deleted on this screen.

1. Press **LIST** on the [Playback Screen](#).

This will open the FILE LIST Screen, which shows a list of files on the microSD card.

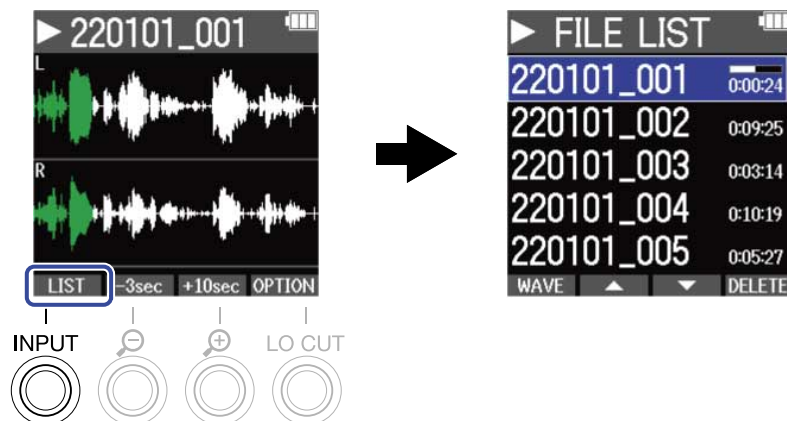

See "[FILE LIST Screen operations](#)" for details about operations when the FILE LIST Screen is open.

### NOTE

On the Playback Screen, all files in a TAKE folder are treated as a single file. For example, if two files named "220101\_001\_Tr1.WAV" and "220101\_001\_Tr2.WAV" have been created in the TAKE folder, a single file named "220101\_001" will be shown on the FILE LIST Screen. If this file is selected and deleted, the operation will be applied to all the files in the TAKE folder. (→ [M4 folder and file structure](#))

# FILE LIST Screen operations

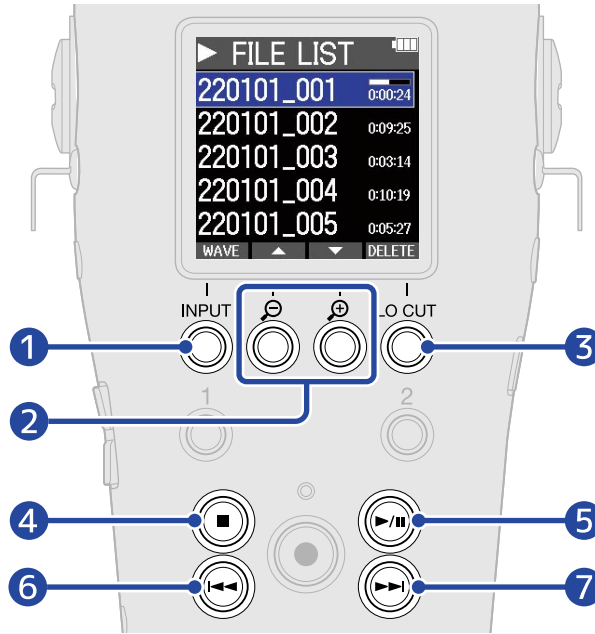

**1** WAVE

This opens the [Playback Screen](#).

**2** ▲ / ▼

Use these to select the previous/next file.

**3** DELETE

This deletes the selected file. (→ [Deleting files on the FILE LIST Screen](#))

**4** ■

This stops playback and reopens the Home Screen.

**5** ▶/||

This pauses and resumes playback.

**6** ◀◀

This moves to the beginning of the file or the previous mark or plays the previous file.  
Press and hold to search backward in the file.

**7** ▶▶

This moves to the next mark or plays the next file.  
Press and hold to search forward in the file.



# Deleting files

The selected file on the [FILE LIST Screen](#) and the playing file on the [Playback Screen](#) can be deleted.

## Deleting files on the FILE LIST Screen

1. On the [FILE LIST Screen](#), use  and  to select the file to delete and press **DELETE**.



2. Use  and  to select "Delete" and press  to confirm.

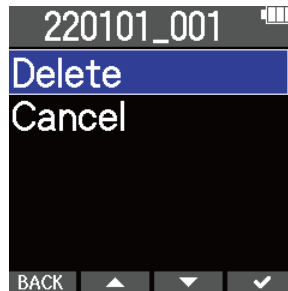

Select "Cancel" to cancel deletion.

### NOTE

Be careful because this will delete all files in the TAKE folder.

### HINT

Files can also be deleted on the Playback Screen. (→ [Deleting the playing file on the Playback Screen](#))

## Deleting the playing file on the Playback Screen

---

1. Press **OPTION** on the [Playback Screen](#).  
This shows the file options.

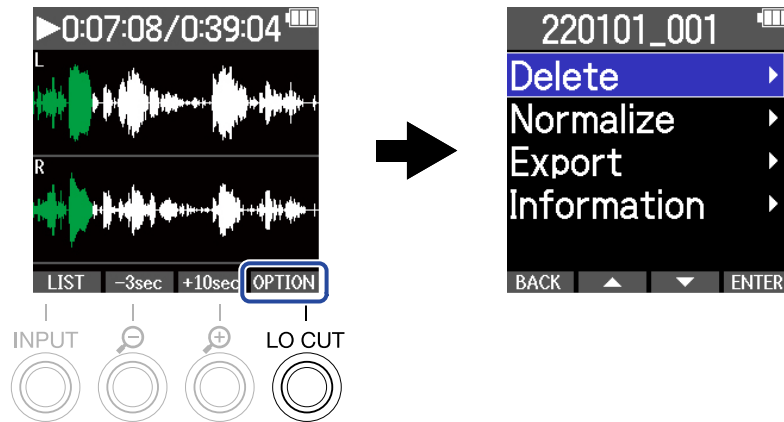

2. Use **▲** and **▼** to select "Delete" and press **ENTER**.

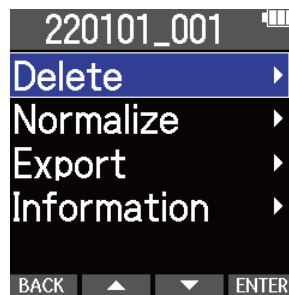

3. Use **▲** and **▼** to select "Delete" and press **✓** to confirm.

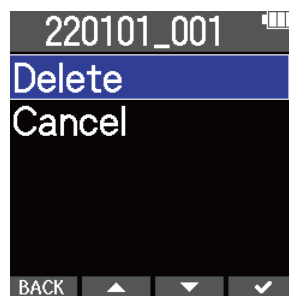

Select "Cancel" to cancel deletion.

---

### HINT

Files can also be deleted on the FILE LIST Screen by pressing **DELETE**. (→ [Deleting files on the FILE LIST Screen](#))

---

# Optimizing file volume (normalization)

Volume can be optimized by normalizing recorded files.

1. Press **OPTION** on the [Playback Screen](#).

This shows the file options.

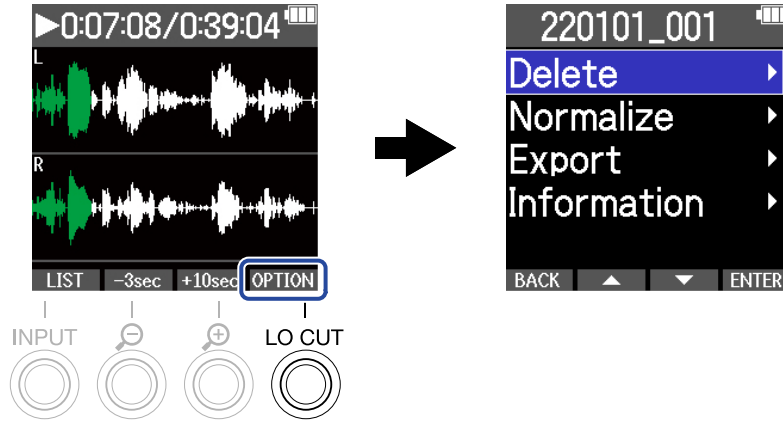

2. Use **▲** and **▼** to select "Normalize" and press **ENTER** to confirm.

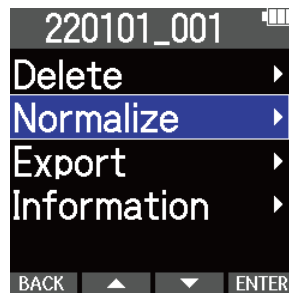

3. Use **▲** and **▼** to select "Execute" and press **✓** to confirm.

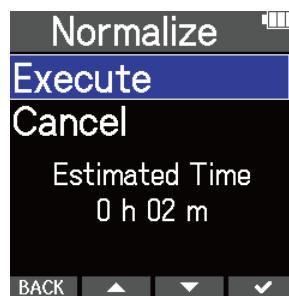

Select "Cancel" to return to the original screen.

## NOTE

Normalized files are saved with the same 32-bit float format and can be played as is on the M4.

## HINT

Normalization is a function that measures the highest volume of the audio data and adjusts the volume, keeping it in a range that does not distort.

# Changing bit depth and exporting files (Export)

The M4 can only record in 32-bit float format, but it can convert recorded files to other formats and export them. This is convenient when loading files recorded by the M4 on computers, smartphones and tablets when the application being used does not support 32-bit float format, for example.

When changing the file format, normalization can also be set to be used or not. The volume of recorded files can be optimized by normalizing.

1. Press **OPTION** on the [Playback Screen](#).

This shows the file options.



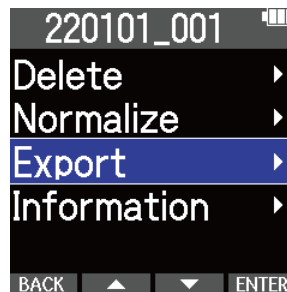

2. Use **▲** and **▼** to select "Export" and press **ENTER** to confirm.



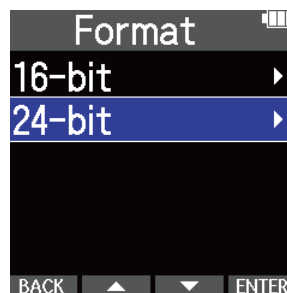

3. Use **▲** and **▼** to select the bit depth to use for the exported file, and press **ENTER** to confirm.



4. Use  and  to select whether or not to normalize and press  to confirm.



Select "On" to normalize.

5. Use  and  to select "Execute" and press  to confirm.

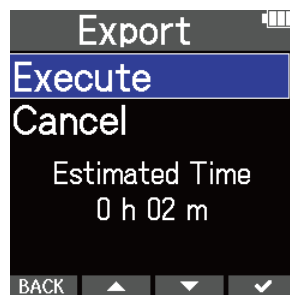

The converted file will be saved in the Export folder.

Select "Cancel" to return to the original screen.

---

#### HINT

Normalization is a function that measures the highest volume of the audio data and adjusts the volume, keeping it in a range that does not distort.

---



# Checking file information

A variety of information about the current playback file can be checked.

1. Press **OPTION** on the [Playback Screen](#).

This shows the file options.

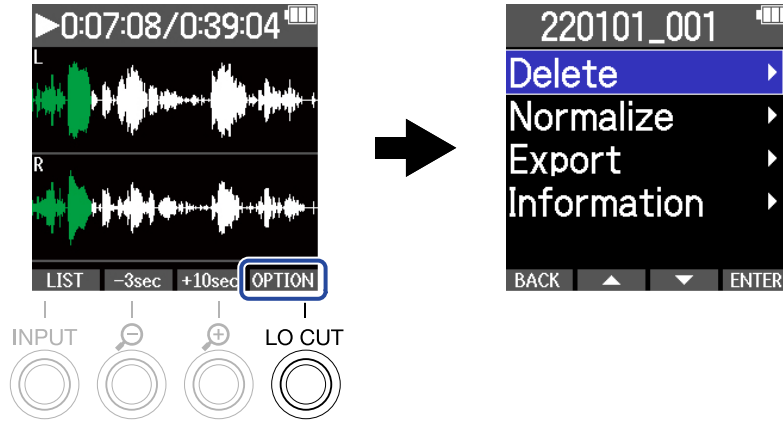

2. Use **▲** and **▼** to select "Information" and press **ENTER** to confirm.

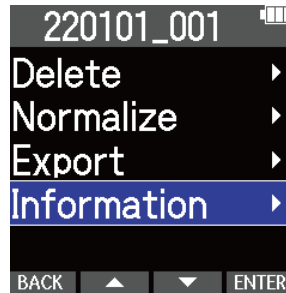

3. Use **▲** and **▼** to check the various information items.

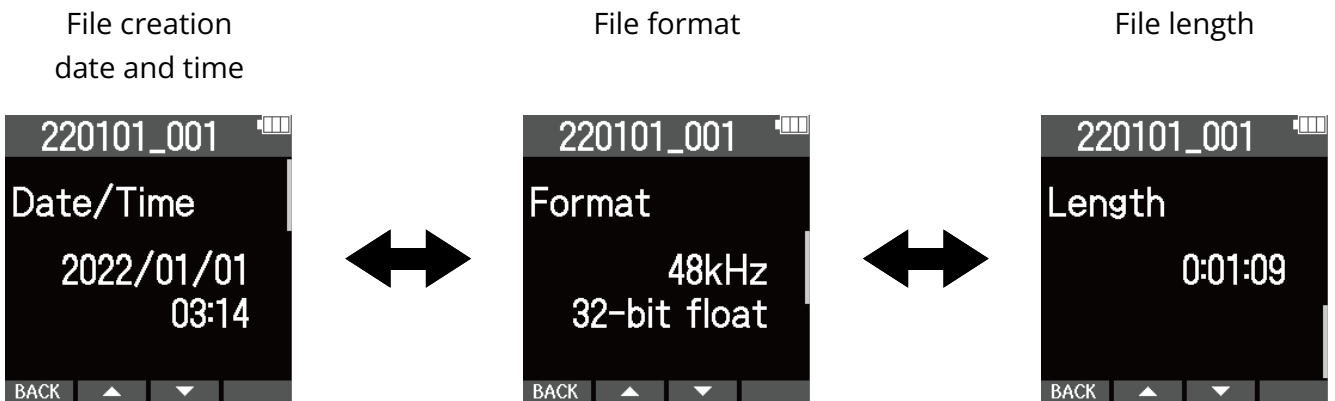

# Using as a USB mic

---

Signals input to the M4 can be sent to computers, smartphones and tablets, and playback signals from these devices can be output from the M4.

Moreover, the M4 can also record audio while being used as a USB mic.

No driver is necessary for use with a Mac, smartphone or tablet.

A driver is necessary for use with Windows.

## For Windows

1. Download the M4 Driver to the computer from [zoomcorp.com](http://zoomcorp.com).

### NOTE

The M4 Driver can be downloaded from the above website.



2. Launch the installer, and follow the instructions to install the M4 Driver.

### NOTE

See the Installation Guide included in the driver package for detailed installation procedures.

## Connecting computers, smartphones and tablets

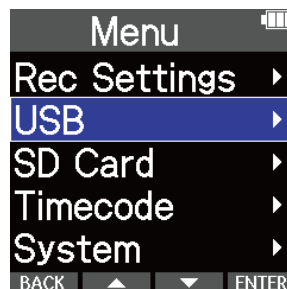

1. Press  when the Home Screen is open.  
This opens the Menu Screen.

2. Use  and  to select "USB" and press  to confirm.



3. Use  and  to select "USB MIC w/REC" and press  to confirm.



4. Use  and  to select the connected device and press  to confirm.  
When connected using the USB mic function, "USB MIC" will appear at the top left of the Home Screen.

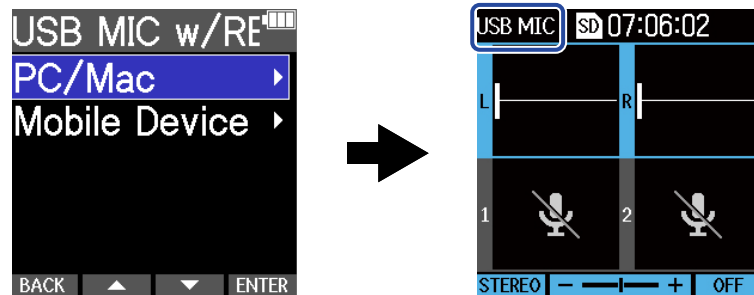

Setting	Explanation
PC/Mac	Use for connecting to a computer.
Mobile Device	Use for connecting to a smartphone or tablet. Please use batteries to power the M4.

**NOTE**

- Bus power operation might not be possible depending on the USB bus power supply capability of the computer. In this case, select "Mobile Device" to power the unit with batteries when connecting.
- When used as a USB mic, the sample rate is 48 kHz.

**5.** Use a USB cable (Type-C) to connect the M4 to the computer, smartphone or tablet.

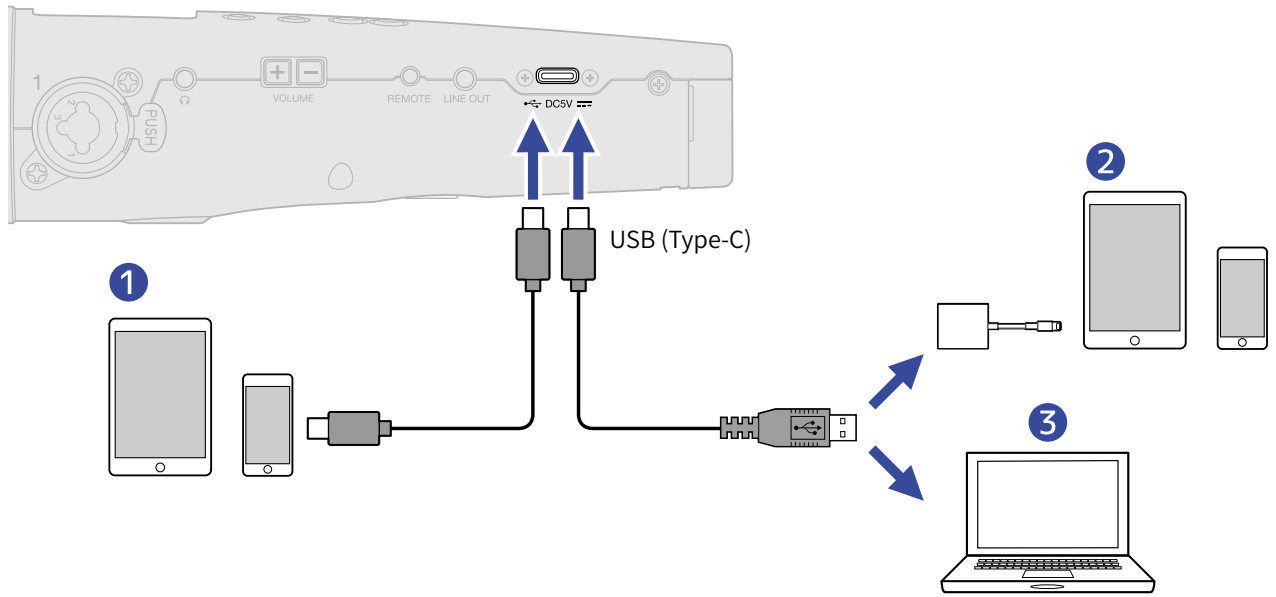

- ① Smartphone/tablet (Android)
- ② Smartphone/tablet (iOS/iPadOS)
- ③ Computer (Windows/Mac)

**NOTE**

- Use a USB cable that supports data transfer.
- Use a Lightning to USB 3 Camera Adapter to connect to an iOS/iPadOS device with a lightning connector.

6. Launch an application on the computer, smartphone or tablet and select the M4 as the “Audio” or “Input/Output” device.

**NOTE**

- Even if “ZOOM M4” cannot be selected in the computer “Sound” settings, the M4 can still be used as a 32-bit float USB mic if it is selected as the “Audio” or “Input/Output” device in an application that supports 32-bit float format.
- See the operation manuals of the applications for information about their operation.

# USB mic muting

When connected using the USB mic function, temporarily muting the sound from the mic is possible so that it is not sent to the computer, smartphone or tablet.

1. Press  when the Home Screen is open (and connected using the USB mic function).

The MUTE message will be shown and output to the computer, smartphone or tablet will be muted.

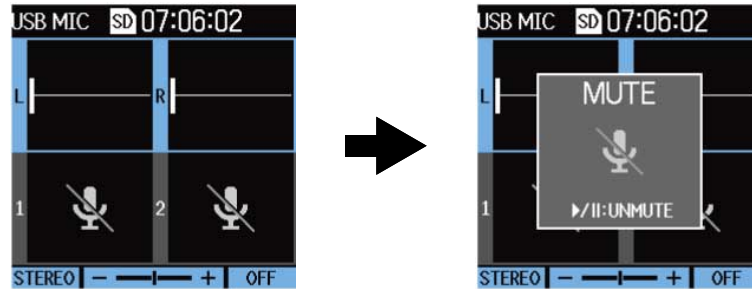

2. Press  when muted.

This unmutes the output and returns to the previous screen.

## NOTE

- The built-in XY mic, INPUT 1 and INPUT 2 will all be muted.
- Sound being recorded and sound output from the headphone and LINE OUT jacks are also muted in the same manner.

# Disconnecting from computers, smartphones and tablets

**1.** Press  when the Home Screen is open (and connection is using the USB mic function).  
This opens the Menu Screen.

**2.** Use  and  to select "Exit USB MIC" and press  to confirm.



**3.** Disconnect the USB cable that is connecting the M4 and the computer, smartphone or tablet.

# Making USB mic settings

When the M4 is used as a USB mic, the monitoring sound and the signal sent to the computer, smartphone or tablet can be set.

## Changing the built-in XY mic stereo/mono setting

The sound captured by the built-in XY mic of the M4 can be mixed to mono for monitoring and sending to the computer, smartphone or tablet. This function is convenient for web streaming and other times when you do not want stereo audio sent to the computer, smartphone or tablet.

**1.** On the Home Screen (when connected using the USB mic function), select the built-in XY mic.  
(→ [Selecting inputs for making settings](#))

**2.** Press **INPUT** repeatedly to select the setting.

The name of the selected setting is shown on the display.

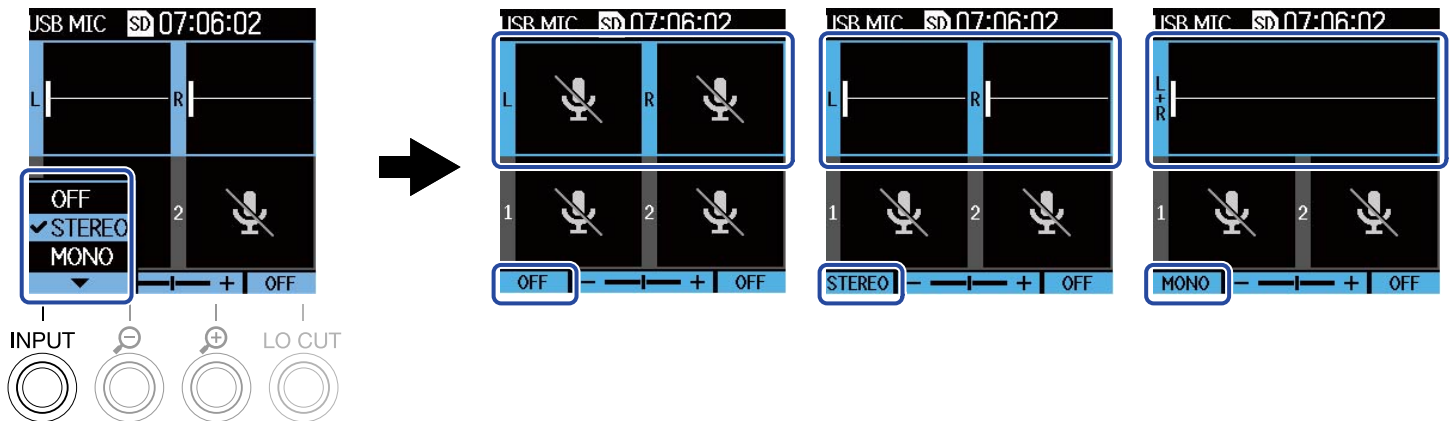

Setting	Explanation
OFF	This turns the built-in XY mic off, so sound from it will not be sent to the computer, smartphone or tablet.
STEREO	Sound from the built-in XY mic will be sent as stereo to the computer, smartphone or tablet.
MONO	Sound from the built-in XY mic will be mixed to mono and sent to the computer, smartphone or tablet.

### NOTE

Sound being recorded and sound output from the headphone and LINE OUT jacks are also switched in the same manner.



## Reducing noise (low-frequency cut)

When using the M4 as a USB mic, low frequencies from the built-in XY mic can be cut, reducing the sound of wind and pop noises, for example.

1. On the Home Screen (when connected using the USB mic function), select the built-in XY mic.  
(→ [Selecting inputs for making settings](#))
2. Press  $\text{LO CUT}$  repeatedly to set the cutoff frequency.  
The selected frequency is shown on the Home Screen.

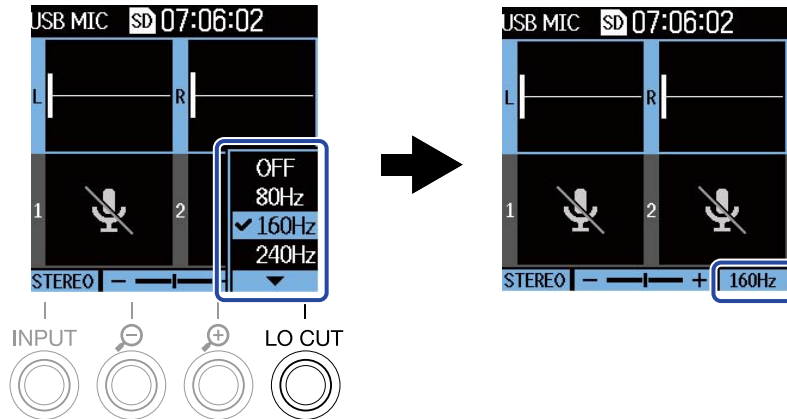

LO CUT can be set to OFF, 80Hz, 160Hz or 240Hz.



# Setting the bit depth

The bit depth can be set for use as a USB mic.



## Precautions when using 32-bit float format

- Always confirm that the app being used on a computer, smartphone or tablet supports 32-bit float format before use.
- Before connecting the M4 to headphones or another device, mute the M4 headphone volume and line output levels. If using an app that does not support 32-bit float format, unexpected loud sound could be output causing harm to hearing, for example.
- A driver is necessary to use 32-bit float format with Windows. Download the driver from the ZOOM website ([zoomcorp.com](http://zoomcorp.com)).



1. Press  when the Home Screen is open (and connection is using the USB mic function). This opens the Menu Screen.

2. Use  and  to select "USB Audio Setting" and press  to confirm.



3. Use  and  to select "Format" and press  to confirm.



4. Use  and  to select the bit depth to use, and press  to confirm.

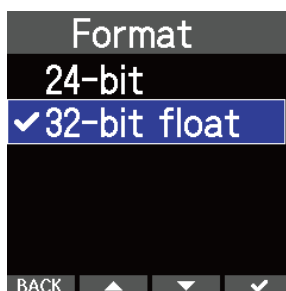



## Enabling direct monitoring

---

This directly outputs the sound being input to the M4 before sending it to the computer, smartphone or tablet. This enables monitoring without latency (direct monitoring function).

1. Press  when the Home Screen is open (and connection is using the USB mic function).

This opens the Menu Screen.

2. Use  and  to select "USB Audio Setting" and press  to confirm.



3. Use  and  to select "Direct Monitor" and press  to confirm.



4. Use  and  to select "On" and press  to confirm.







# Transferring files to computers and other devices

---

By connecting the M4 to a computer, smartphone or tablet, files on the microSD card can be checked and moved.

## Connecting computers, smartphones and tablets

1. Press  when the Home Screen is open.  
This opens the Menu Screen.

2. Use  and  to select "USB" and press  to confirm.

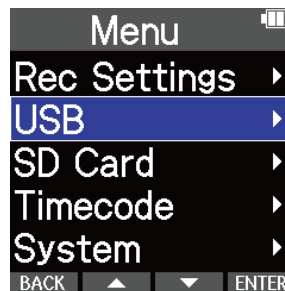

3. Use  and  to select "File Transfer" and press  to confirm.

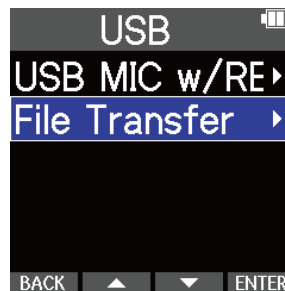

4. Use  and  to select the connected device and press  to confirm.

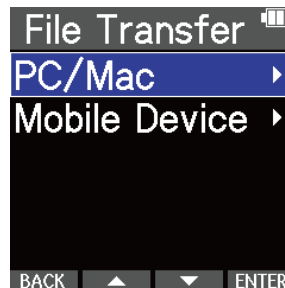

Setting	Explanation
PC/Mac	Use for connecting to a computer.
Mobile Device	Use for connecting to a smartphone or tablet. Please use batteries to power the M4.

This opens the File Transfer Screen.

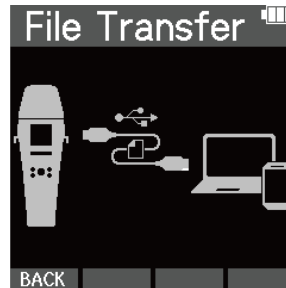

**5.** Use a USB cable (Type-C) to connect the M4 to the computer, smartphone or tablet.

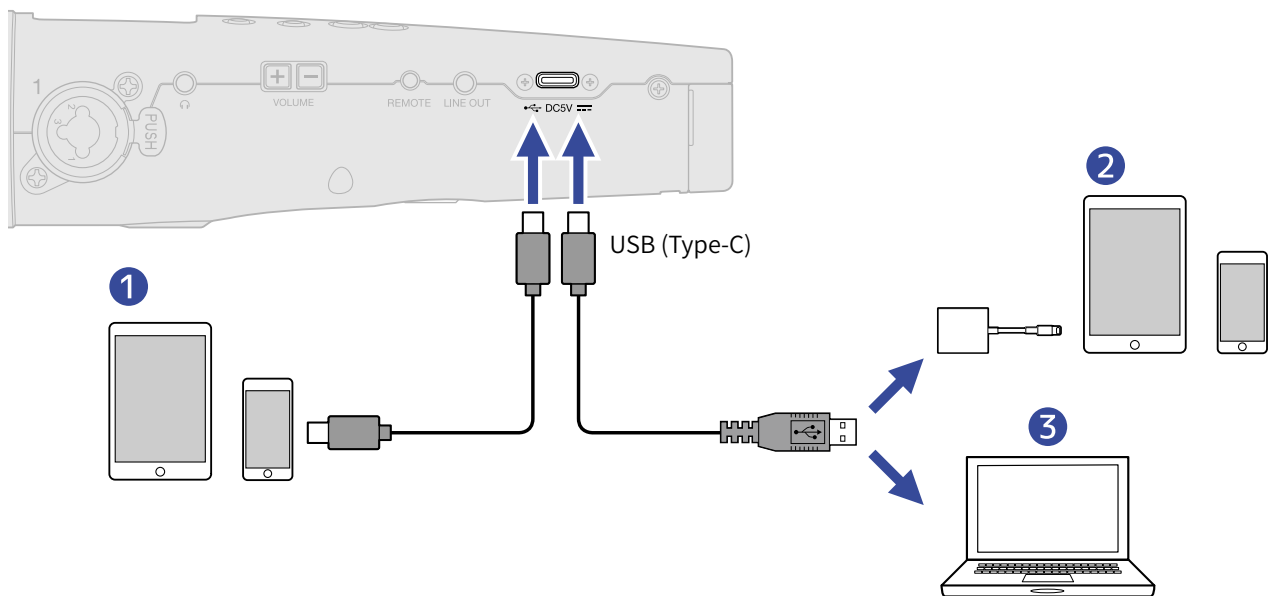





- ① Smartphone/tablet (Android)
- ② Smartphone/tablet (iOS/iPadOS)
- ③ Computer (Windows/Mac)

**NOTE**

- Use a USB cable that supports data transfer.
- Use a Lightning to USB 3 Camera Adapter to connect to an iOS/iPadOS device with a lightning connector.

**6.** Use the computer, smartphone or tablet to work with files saved on the microSD card.

# Disconnecting from computers, smartphones and tablets

1. End the connection from the computer, smartphone or tablet.
  - Windows:  
Select M4 from "Safely Remove Hardware and Eject Media".
  - macOS:  
Drag the M4 icon to the Trash and drop it.
  - Smartphone/tablet:  
Refer to the operation manual for the device.
2. Press  or **BACK** .  
This opens a confirmation screen.
3. Use  and  to select "End" and press  to confirm.
4. Disconnect the USB cable that is connecting the M4 and the computer, smartphone or tablet.

## NOTE



Always conduct step 1 before disconnecting the USB cable.

# Managing microSD cards



## Formatting microSD cards

To maximize the performance of a microSD card, format it for use with the M4.

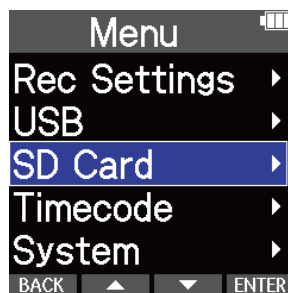

1. Press  when the Home Screen is open.  
This opens the Menu Screen.

2. Use  and  to select "SD Card" and press  to confirm.

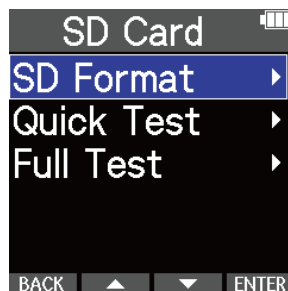

3. Use  and  to select "SD Format" and press  to confirm.



4. Use  and  to select "Execute" and press  to confirm.

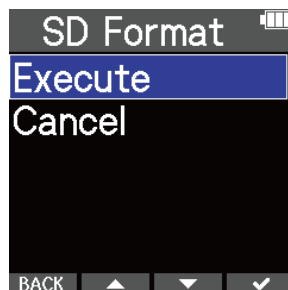

This formats the microSD card.

## NOTE

- The microSD card formatting screen can also be opened by pressing  while turning the power on.
- Always format microSD cards in order to maximize their performance after purchasing them new or using them with a different device.
- Be aware that all data on the microSD card will be deleted when it is formatted.







# Testing microSD cards

This tests whether the microSD card writing speed performance can save data recorded by the M4 without problems.



A Quick Test can be done in a short amount of time, while a Full Test examines the entire microSD card.

## Conducting a quick test

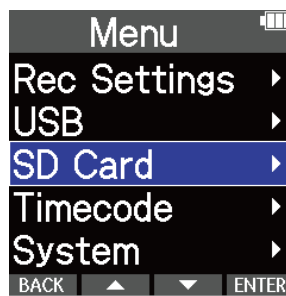

1. Press  when the Home Screen is open.  
This opens the Menu Screen.

2. Use  and  to select "SD Card" and press  to confirm.

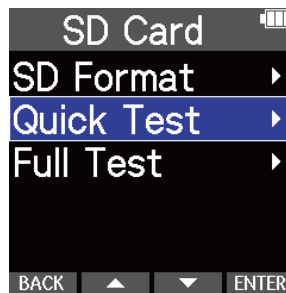

3. Use  and  to select "Quick Test" and press  to confirm.



4. Use  and  to select "Execute" and press  to confirm.  
The card performance test will start.

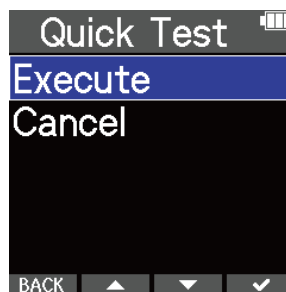

The result of the test will be shown when it completes.

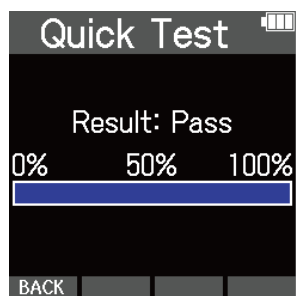

---

**NOTE**

Even if a performance test result is "OK", there is no guarantee that writing errors will not occur. This information is just to provide guidance.

---

**HINT**



Testing can be canceled while in progress by pressing **BACK** .

---



## Conducting a full test

---

1. Press  when the Home Screen is open.  
This opens the Menu Screen.

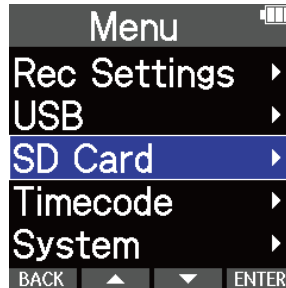

2. Use  and  to select "SD Card" and press  to confirm.

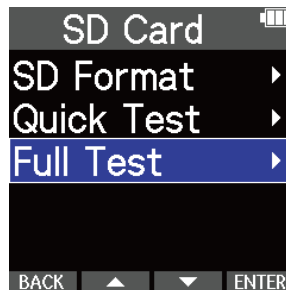

3. Use  and  to select "Full Test" and press  to confirm.



The amount of time required for the full test will be shown.

4. Use  and  to select "Execute" and press  to confirm.  
The card performance test will start.

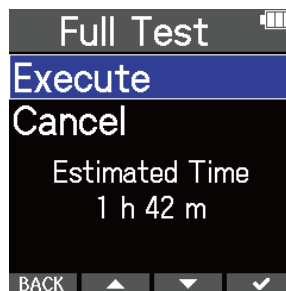

The result of the test will be shown when it completes.

If the access rate MAX reaches 100%, the card will fail (NG).

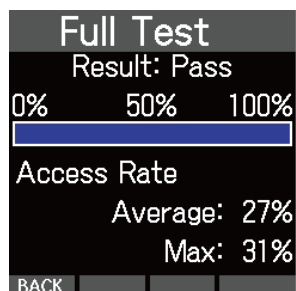

**NOTE**

Even if a performance test result is "OK", there is no guarantee that writing errors will not occur. This information is just to provide guidance.

**HINT**

Testing can be paused by pressing **PAUSE** , and resumed by pressing **RESTART** .

Testing can be canceled while in progress by pressing **BACK** .

# Using timecode

---

## Timecode overview

The M4 can input and output SMPTE timecode.

Timecode is time information written to data when recording video and audio. It is used for video editing, control of other devices, and synchronization of audio and video, for example.

## Using timecode for editing

---

If video and audio data both have recorded timecode, aligning them to a timeline and synchronizing them together is easy when using nonlinear editing software for editing.

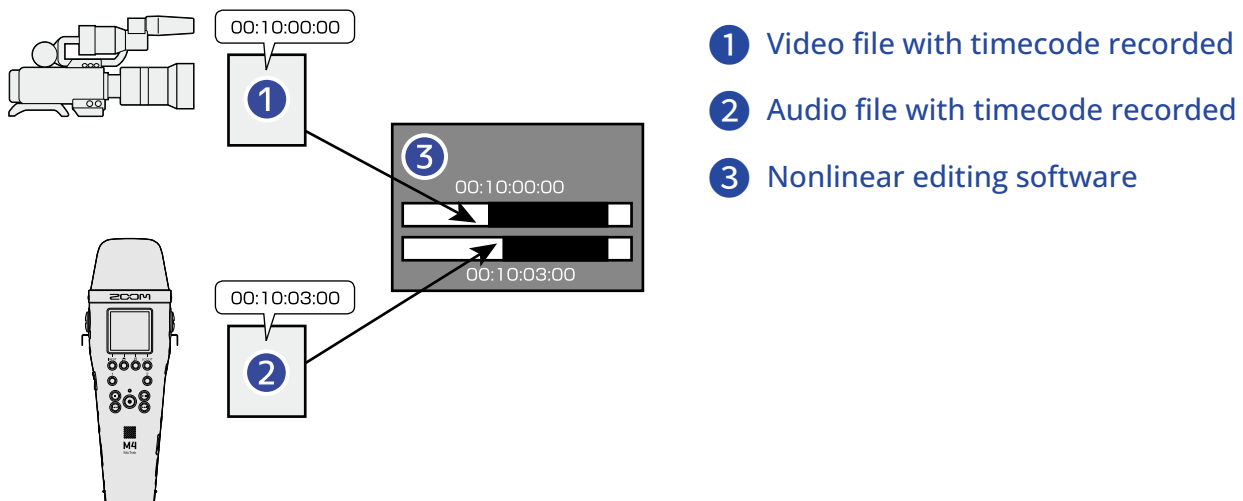

---

### HINT

The M4 uses a high-precision oscillator that enables the generation of accurate timecode with a discrepancy of less than 0.5 frames per 24 hours.

---

## Connection examples

Connections like the following are possible according to application.

### ■ Synchronizing with cameras that do not have timecode input/output connectors

The M4 can write timecode that it generates itself to its own audio data while it simultaneously outputs timecode from its TIME CODE IN/OUT jack.

Connect the TIME CODE IN/OUT jack on the M4 with the audio input jack on the camera for an external mic or other device.

The timecode received by the camera is recorded to the audio of the video data.

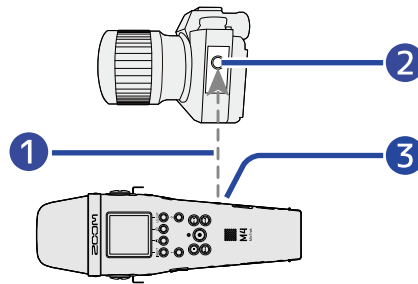

- 1 Timecode
- 2 Audio input jack
- 3 TIME CODE IN/OUT jack (3.5 mm stereo mini)

### ■ Synchronizing with cameras that have timecode input/output connectors

The M4 can write timecode that it generates itself to its own audio data while it simultaneously outputs timecode from its TIME CODE IN/OUT jack.

Connect the TIME CODE IN/OUT jack on the M4 with the timecode input/output jack on the camera.

The timecode received by the camera is recorded with the video data as metadata.

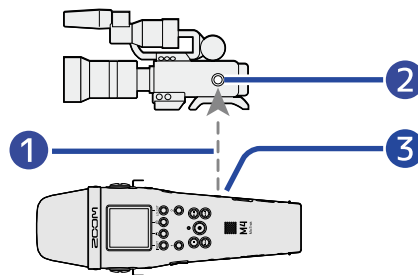

- 1 Timecode
- 2 Timecode input/output jack
- 3 TIME CODE IN/OUT jack (3.5 mm stereo mini)

## ■ Inputting timecode from another device

Timecode is transmitted from the timecode generator.

Both the M4 and the video camera receive timecode and record it with their audio and video data.

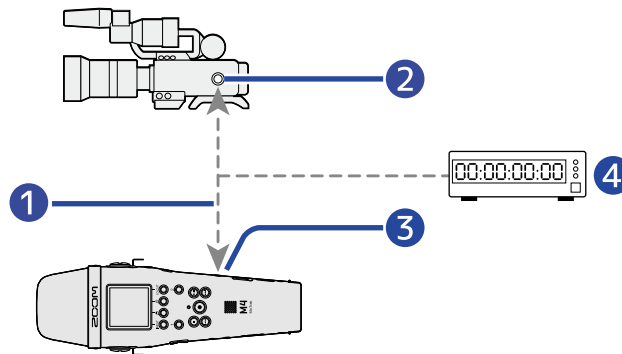

- 1 Timecode
- 2 Timecode input/output jack
- 3 TIME CODE IN/OUT jack (3.5 mm stereo mini)
- 4 Timecode generator



# Making timecode settings

## Setting the timecode mode



Use this setting to enable/disable the M4 timecode function.

When the M4 timecode function is enabled, timecode can be set to run freely or it can be set to follow an external timecode source.

1. Press  when the Home Screen is open.  
This opens the Menu Screen.

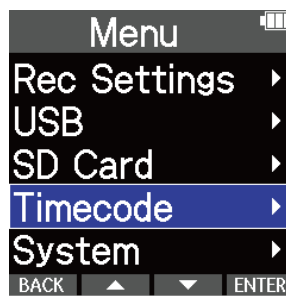

2. Use  and  to select "Timecode" and press  to confirm.

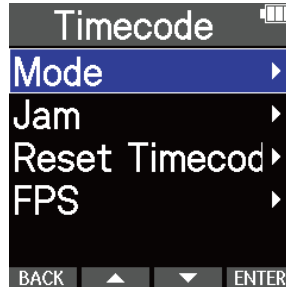

3. Use  and  to select "Mode" and press  to confirm.





4. Use  and  to select the mode to set, and press  to confirm.

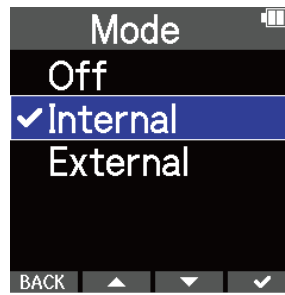



Setting	Explanation
Off	No timecode will be written to recording files. Timecode will not be output from the TIME CODE IN/OUT jack.
Internal	Internal timecode will run at all times.
External	The internal timecode will chase the external timecode.

# Setting the frame rate for internal timecode

When using timecode, frame rates must be set to be the same for devices being used and video and audio data.

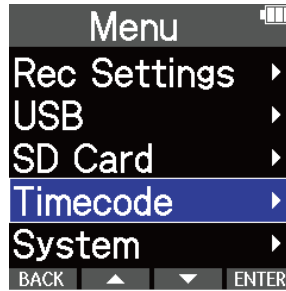

1. Press  when the Home Screen is open.  
This opens the Menu Screen.

2. Use  and  to select "Timecode" and press  to confirm.

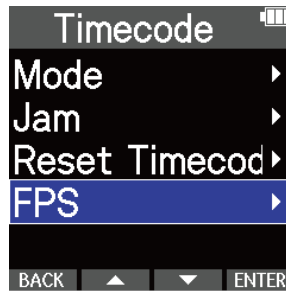

3. Use  and  to select "FPS" and press  to confirm.



4. Use  and  to select a frame rate and press  to confirm.

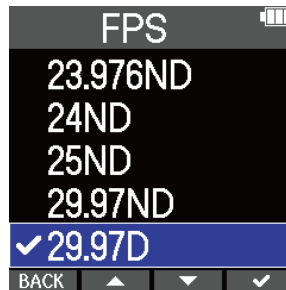

Setting	Explanation
23.976ND	This is the most common frame rate used with HD cameras and other high-definition video recording. The count is slower than the actual time by 0.1%.
24ND	This is the standard frame rate used for film recording. This is also used with HD cameras.
25ND	This is the frame rate for PAL video. This is used for PAL video, which is used in Europe and other regions.

Setting	Explanation
29.97ND	This is a frame rate used for NTSC color video and HD cameras. The count is slower than the actual time by 0.1%. This is used for NTSC video, which is used in Japan, the United States and other countries.
29.97D	This is an adjusted frame rate that uses a drop frame to make NTSC match the actual time. This is used with video for broadcast that requires the actual time frame to be matched.
30ND	This is used to synchronize sound with film that is being transferred to NTSC video. This is the standard frame rate used for black-and-white television in Japan, the United States and other countries.
30D	This rate is used for special applications. This synchronizes at 29.97 fps drop frame with film sound to be transferred to NTSC. The count is faster than the actual time by 0.1%.



**NOTE**

- Frame rate settings must match for devices used and all video and audio data.
- This can only be set when “Mode” is “Internal”. (→ [Setting the timecode mode](#))

# Using external timecode to set the internal timecode (jamming)

Timecode input through the TIME CODE IN/OUT jack can be used to set internal timecode.

1. Press  when the Home Screen is open.  
This opens the Menu Screen.

2. Use  and  to select "Timecode" and press  to confirm.

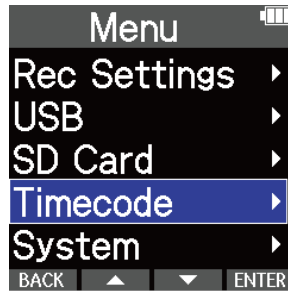

3. Use  and  to select "Jam" and press  to confirm.

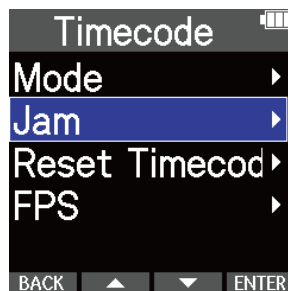

4. Press  .

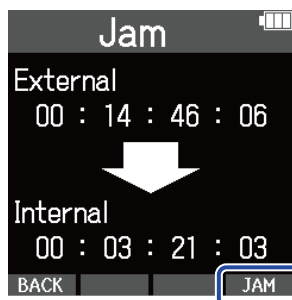

The external timecode value will be used to set the internal timecode.



## NOTE

This can only be set when "Mode" is "Internal". (→ [Setting the timecode mode](#))

## Resetting internal timecode

The internal timecode value can be reset to "00:00:00:00".

1. Press  when the Home Screen is open.  
This opens the Menu Screen.

2. Use  and  to select "Timecode" and press  to confirm.

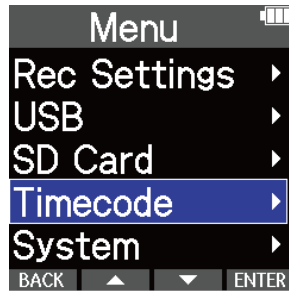

3. Use  and  to select "Reset Timecode" and press  to confirm.

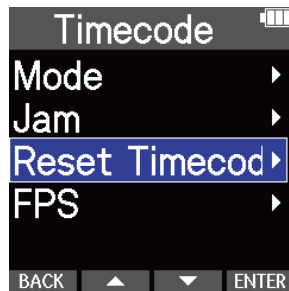

This resets the timecode value to "00:00:00:00".

### NOTE

This can only be set when "Mode" is "Internal". (→ [Setting the timecode mode](#))



# Making various settings

---



## Setting the language shown

The language shown on the M4 screen can be changed.

1. Press  when the Home Screen is open.  
This opens the Menu Screen.

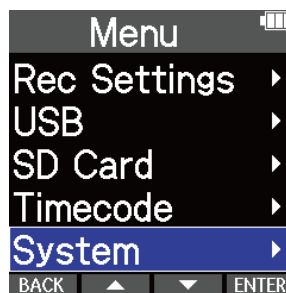
2. Use  and  to select "System" and press  to confirm.



3. Use  and  to select "Language" and press  to confirm.



4. Use  and  to select the language to show, and press  to confirm.



---

### HINT

The first time you turn the power on after purchase, this screen opens automatically.



---

# Setting the date and time

Use this to set the date and time added to recording files.

1. Press  when the Home Screen is open.

This opens the Menu Screen.

2. Use  and  to select "System" and press  to confirm.

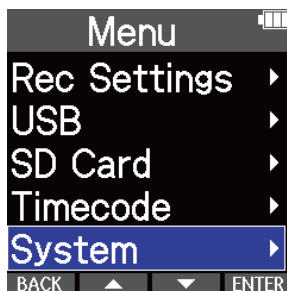



3. Use  and  to select "Date/Time" and press  to confirm.



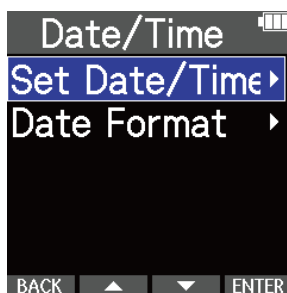

4. Use  and  to select "Set Date/Time" and press  to confirm.



5. Use  and  to select the item to set, and press  to confirm.



6. Use  and  to change the value, and press  to confirm.



7. Repeat steps 5–6 to set the date and time.

8. After setting all items, use  and  to select , and press  to confirm.

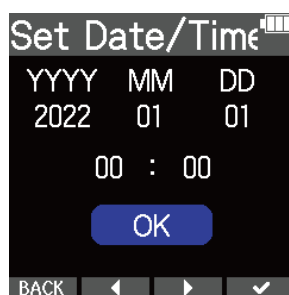

**NOTE**

Changing the date and time will also reset the take numbers used for recording files.

**HINT**

The first time you turn the power on after purchase, this screen opens automatically after you set the date format.





# Setting the date format



The date format used with recording files can be changed.

1. Press  when the Home Screen is open.



This opens the Menu Screen.

2. Use  and  to select "System" and press  to confirm.





3. Use  and  to select "Date/Time" and press  to confirm.

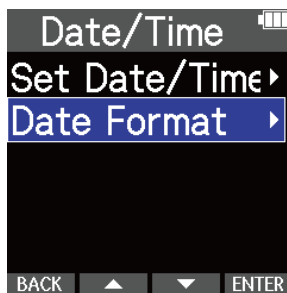

4. Use  and  to select the date format, and press  to confirm.



5. Use  and  to select the date format, and press  to confirm.

The current set date will be shown at the bottom of the screen as a concrete example of the date format set.

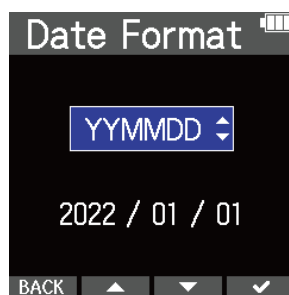

Setting	Explanation
YYMMDD	The date is shown in year, month, day order.
MMDDYY	The date is shown in month, day, year order.
DDMMYY	The data shown in day, month, year order.

**NOTE**

Changing the date format will also reset the take numbers used for recording files.

**HINT**



The first time you turn the power on after purchase, this screen opens automatically after you set the language shown.

# Setting display power saving



To conserve energy, the display backlight can be set to dim after a set amount of time without use.

1. Press  when the Home Screen is open.

This opens the Menu Screen.

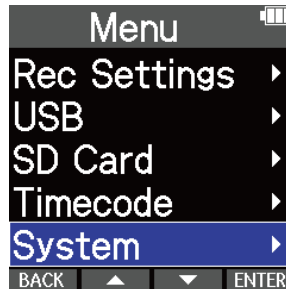
2. Use  and  to select "System" and press  to confirm.





3. Use  and  to select "Display" and press  to confirm.



4. Use  and  to select "Power Saving" and press  to confirm.



5. Use  and  to select a setting, and press  to confirm.





Setting	Explanation
Off	The display backlight always stays bright.
On	The display backlight always stays dark.
30 seconds	The display backlight becomes dark if no operation occurs for 30 seconds.

# Setting the display brightness

The brightness can be adjusted if the display appears too light or too dark, making it difficult to view.

1. Press  when the Home Screen is open.

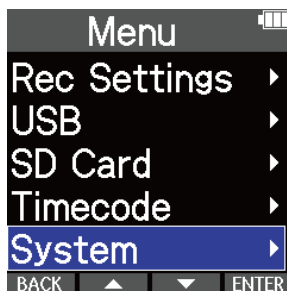

This opens the Menu Screen.

2. Use  and  to select "System" and press  to confirm.

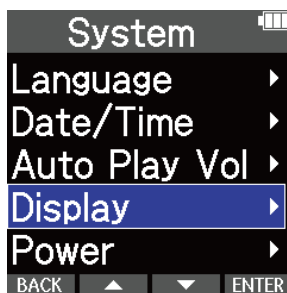

3. Use  and  to select "Display" and press  to confirm.



4. Use  and  to select "Brightness" and press  to confirm.



5. Use  and  to set the display brightness, and press  to confirm.



---

**HINT**



This can be set from 5 to 100.

---



## Setting the type of batteries used

Set the type of battery used by the M4 correctly so that the amount of remaining battery charge can be accurately displayed.

1. Press  when the Home Screen is open.  
This opens the Menu Screen.

2. Use  and  to select "System" and press  to confirm.





3. Use  and  to select "Power" and press  to confirm.



4. Use  and  to select "Battery Type" and press  to confirm.



5. Use  and  to select the battery type, and press  to confirm.

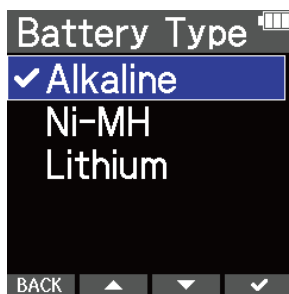

Setting	Explanation
Alkaline	Alkaline batteries
Ni-MH	Nickel-metal hydride batteries
Lithium	Lithium batteries

---

**HINT**

The first time you turn the power on after purchase, the battery type setting is shown after you set the date and time.



---







# Setting the time until the power turns off automatically

The M4 can be set to automatically turn off if it is not operated for a specific amount of time. To keep the power on at all times, set Auto Power Off to Off.

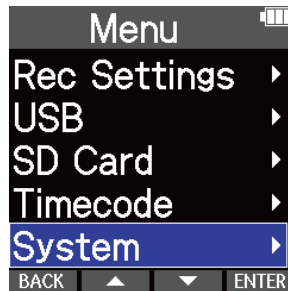

1. Press  when the Home Screen is open.  
This opens the Menu Screen.

2. Use  and  to select "System" and press  to confirm.





3. Use  and  to select "Power" and press  to confirm.

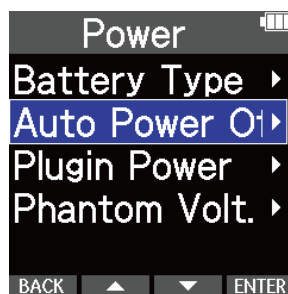

4. Use  and  to select "Auto Power Off" and press  to confirm.



5. Use  and  to select the amount of time until the power turns off, and press  to confirm.

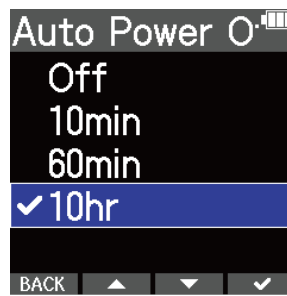

Setting	Explanation
Off	The power will not turn off automatically.
10 min	The power will automatically turn off if it is unused for 10 minutes.
60 min	The power will automatically turn off if it is unused for 60 minutes.
10 hours	The power will automatically turn off if it is unused for 10 hours.

**NOTE**



Regardless of the Auto Power Off setting, the power will not turn off automatically under the following conditions.

- When recording or playing back
- When the M4 is being used as a USB mic
- When the M4 file transfer function is being used
- When a card test is being executed
- When firmware is being updated

# Restoring factory default settings

You can restore the M4 settings to their factory defaults.

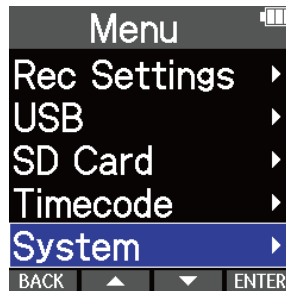

1. Press  when the Home Screen is open.  
This opens the Menu Screen.

2. Use  and  to select "System" and press  to confirm.

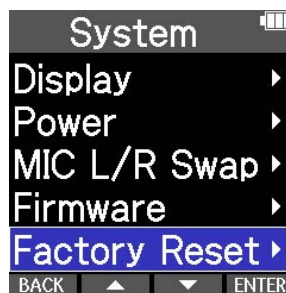

3. Use  and  to select "Factory Reset" and press  to confirm.



4. Use  and  to select "Execute" and press  to confirm.



This will restore the M4 to its factory default state and turn the power off.

## NOTE



Resetting will overwrite all settings to their factory defaults. Be certain before using this function.

# Managing the firmware



## Checking firmware versions

The firmware versions used by the M4 can be checked.

1. Press  when the Home Screen is open.  
This opens the Menu Screen.

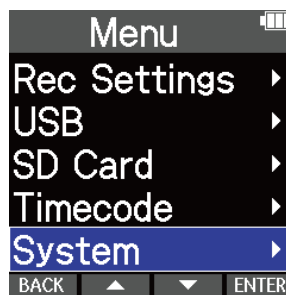
2. Use  and  to select "System" and press  to confirm.



3. Use  and  to select "Firmware" and press  to confirm.



This shows the firmware versions.

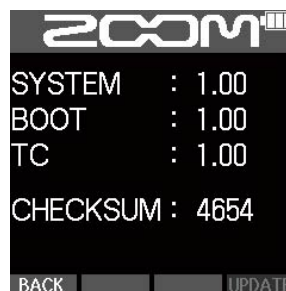

## Updating the firmware

The M4 firmware can be updated to the latest versions.

Files for the latest firmware updates can be downloaded from the ZOOM website ([zoomcorp.com](https://zoomcorp.com)).

Follow the instructions in the “M4 Firmware Update Guide” on the M4 download page.

# Using optional remote controls

The M4 can be operated from a distance using an optional remote control (RC2, RC4, RCH-5 or RCH-6).

1. Connect the remote control to the REMOTE jack on the M4.

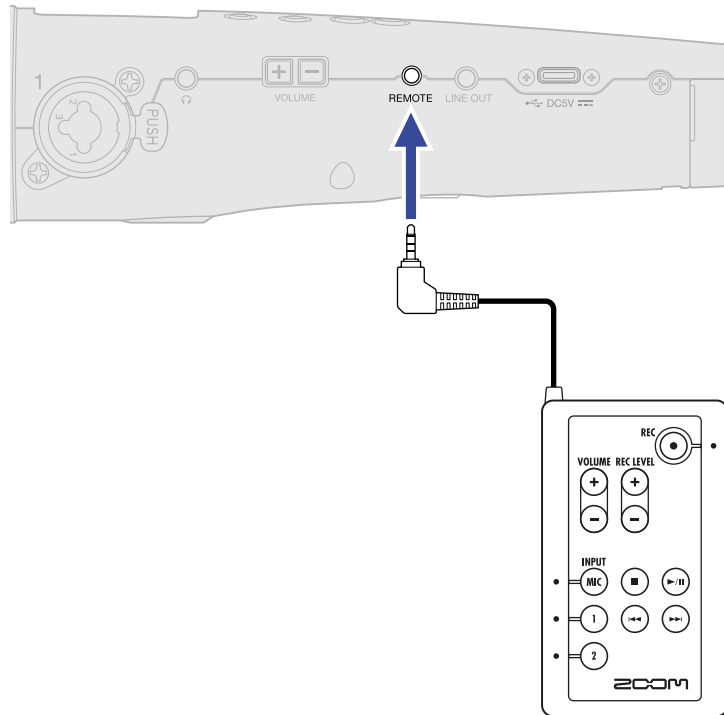

2. Use the remote control.

The highlighted buttons and indicators of each remote control correspond to those on the M4.

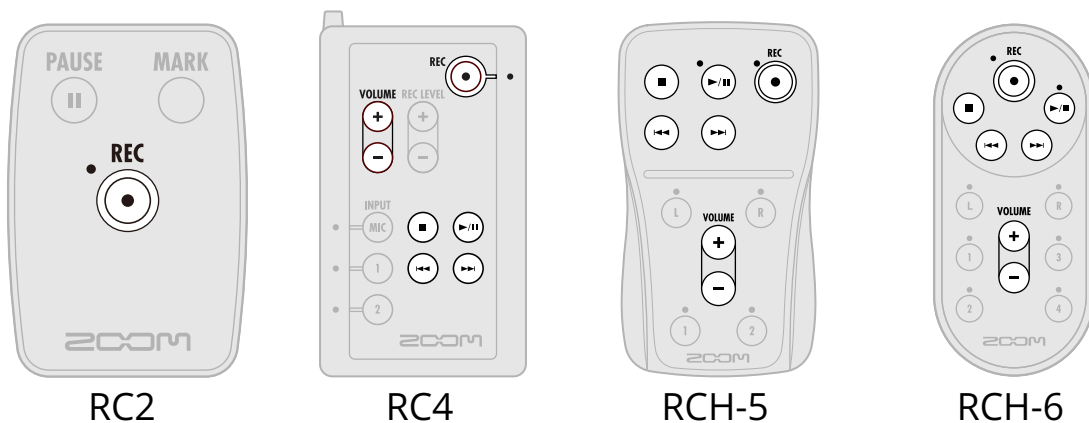

## NOTE

- The M4 hold function has no effect on remote control operations. (→ [Preventing misoperation \(hold function\)](#))

# Appendix

---

## Troubleshooting

If you think that the M4 is operating strangely, check the following items first.

### Recording/playback trouble

---

#### There is no sound or output is very quiet

- Check the orientation of the mic or the volume settings of the connected equipment.
- Confirm that the headphone volume and line output level are not too low. (→ [Monitoring input and playback sounds](#), [Adjusting the line output level](#))
- Check the M4 input source settings. (→ [Changing the audio format used for input from the built-in XY mic](#), [Setting INPUT 1/2 sources, phantom power and stereo linking](#))
- Plug-in power must be supplied if the mic connected to the MIC/LINE IN jack supports plug-in power. (→ [Using plugin power](#))
- Increase the volume amplification on the display for the input signal, and increase the monitoring volume. (→ [Adjusting the volume display size to make checking easier](#))
- Check the phantom power settings. (→ [Setting INPUT 1/2 sources, phantom power and stereo linking](#), [Changing phantom power voltage](#))

#### Monitored sound is distorted

- Adjust the volume amplification on the display. (→ [Adjusting the volume display size to make checking easier](#))

#### Built-in mic sound is distorted

- Move the M4 away from the sound source. Use a windscreen if air is blown at the mic. (→ [Reducing noise \(low-frequency cut\)](#))

#### INPUT 1/2 sound is distorted

- Adjust the volume of the connected device, and confirm that the M4 input source setting is correct. (→ [Setting INPUT 1/2 sources, phantom power and stereo linking](#))

#### Recording is not possible

- Recording can only be started on the Home Screen. (→ [Recording](#))
- Confirm that the microSD card has open space. The available recording time can be checked on the screen when recording is paused. (→ [Home Screen](#))
- Confirm that a microSD card is loaded properly in the card slot. (→ [Inserting microSD cards](#))

- Confirm that the input source setting is not “Off”. (→ [Changing the audio format used for input from the built-in XY mic, Setting INPUT 1/2 sources, phantom power and stereo linking](#))

## Recorded sound cannot be heard or is very quiet

- Confirm that the input source setting is correct for the connected device. (→ [Setting INPUT 1/2 sources, phantom power and stereo linking](#))

## “MIC INPUT OVERLOAD!”, “INPUT 1 OVERLOAD!” or “INPUT 2 OVERLOAD!” messages appear

- The volume input to the mic is too loud. Increase the distance between the mic and the sound source.
- Wind can cause loud noise to be input. We recommend using a windscreen if air is blown directly at the mic, for example, when recording outdoors or when the mic is near the mouth of a speaker. (→ [Reducing noise \(low-frequency cut\)](#))

## The left and right input channels of the built-in mic sound reversed

- Confirm that the correct switching setting is being used for the left and right audio signals input from the built-in XY mic. (→ [Switching the left and right audio signals input from the built-in XY mic](#))

## Other trouble

### The recorder is not recognized by a computer, smartphone or tablet even though the USB port is connected to it.

- Use a USB cable that supports data transfer.
- The operation mode must be set on the M4 to allow the computer, smartphone or tablet to recognize it. (→ [Using as a USB mic, Transferring files to computers and other devices](#))
- When using as a 32-bit float USB mic, confirm that the computer, smartphone or tablet and applications being used support 32-bit float format.
- Even if “ZOOM M4” cannot be selected in the computer “Sound” settings, the M4 can still be used as a 32-bit float USB mic if it is selected as the “Audio” or “Input/Output” device in an application that supports 32-bit float format.
- A driver is necessary to use 32-bit float format with Windows. Download the driver from the ZOOM website ([zoomcorp.com](http://zoomcorp.com)).

### Battery operation time is short

Making the following settings could increase the battery operation time.

- Set the type of batteries used correctly. (→ [Setting the type of batteries used](#))
- Turn off inputs that are not being used. (→ [Changing the audio format used for input from the built-in XY mic, Setting INPUT 1/2 sources, phantom power and stereo linking](#))
- Set the phantom power voltage to 24 V. (→ [Changing phantom power voltage](#))
- Set the display to dim when not used for a certain amount of time. (→ [Setting display power saving](#))
- Reduce the display brightness. (→ [Setting the display brightness](#))



- Reduce the sampling rate used to record files. (→ [Setting the sample rate](#))
- Disconnect unnecessary cables from the headphone and LINE OUT jacks.
- Due to their characteristics, using nickel metal hydride batteries (especially high-capacity ones) or lithium batteries should enable longer use than alkaline batteries when power consumption is high.

## M4 metadata lists

### Metadata contained in BEXT chunks in WAV files

Tag	Explanation	Remarks
zSPEED=	Frame rate	Menu > Timecode > FPS
zTAKE=	Take number	
zUBITS=	User bits	Menu > System > Date/Time
zSCENE=	Scene name	Menu > System > Date/Time
zTAPE=		
zCIRCLED=		
zTRK1=	Track 1 name	Track names are written as follows. zTRK1=TrMicL, zTRK2=TrMicR, zTRK3=Tr1, zTRK4=Tr2
zTRK2=	Track 2 name	
zTRK3=	Track 3 name	
zTRK4=	Track 4 name	
zNOTE=		

## Metadata contained in iXML chunks in WAV files

○ = YES × = NO

iXML master tag	iXML sub tag	Written	Read	Remarks
<PROJECT>		○	×	
<SCENE>		○	○	Menu > System > Date/Time
<TAKE>		○	○	
<TAPE>		○	×	
<CIRCLED>		○	×	
<WILD TRACK>		×	×	
<FALSE START>		×	×	
<NO GOOD>		×	×	
<FILE UID>		○	×	
<UBITS>		○	×	Menu > System > Date/Time
<NOTE>		○	×	
<BEXT>		×	×	
<USER>		×	×	

iXML master tag	iXML sub tag	Written	Read	Remarks
<SPEED>				
<SPEED>	<NOTE>	○	×	
<SPEED>	<MASTER_SPEED>	○	×	Menu > Timecode > FPS
<SPEED>	<CURRENT_SPEED>	○	×	Menu > Timecode > FPS
<SPEED>	<TIMECODE_RATE>	○	×	Menu > Timecode > FPS
<SPEED>	<TIMECODE_FLAG>	○	×	Menu > Timecode > FPS
<SPEED>	<FILE_SAMPLE_RATE>	○	○	Menu > Rec Settings > Sample Rate
<SPEED>	<AUDIO_BIT_DEPTH>	○	×	
<SPEED>	<DIGITIZER_SAMPLE_RATE>	○	×	Menu > Rec Settings > Sample Rate
<SPEED>	<TIMESTAMP_SAMPLES_SINCE_MIDNIGHT_HI>	○	×	
<SPEED>	<TIMESTAMP_SAMPLES_SINCE_MIDNIGHT_LO>	○	×	
<SPEED>	<TIMESTAMP_SAMPLE_RATE>	○	×	Menu > Rec Settings > Sample Rate



iXML master tag	iXML sub tag	Written	Read	Remarks
<SYNC_POINT_LIST>				
<SYNC_POINT>	<SYNC_POINT_TYPE>	x	x	
<SYNC_POINT>	<SYNC_POINT_FUNCTION>	x	x	
<SYNC_POINT>	<SYNC_POINT_COMMENT>	x	x	
<SYNC_POINT>	<SYNC_POINT_LOW>	x	x	
<SYNC_POINT>	<SYNC_POINT_HIGH>	x	x	
<SYNC_POINT>	<SYNC_POINT_EVENT_DURATION>	x	x	

iXML master tag	iXML sub tag	Written	Read	Remarks
<HISTORY>				
<HISTORY>	<ORIGINAL_FILENAME>	○	x	
<HISTORY>	<PARENT_FILENAME>	x	x	
<HISTORY>	<PARENT_UID>	x	x	

iXML master tag	iXML sub tag	Written	Read	Remarks
<FILE_SET>				
<FILE_SET>	<TOTAL_FILES>	○	x	
<FILE_SET>	<FAMILY_UID>	○	x	
<FILE_SET>	<FAMILY_NAME>	x	x	
<FILE_SET>	<FILE_SET_START_TIME_HI>	x	x	
<FILE_SET>	<FILE_SET_START_TIME_LO>	x	x	
<FILE_SET>	<FILE_SET_INDEX>	○	x	

iXML master tag	iXML sub tag	Written	Read	Remarks
<TRACK_LIST>				
<TRACK_LIST>	<TRACK_COUNT>	○	×	
<TRACK>	<CHANNEL_INDEX>	○	×	
<TRACK>	<INTERLEAVE_INDEX>	○	×	
<TRACK>	<NAME>	○	×	
<TRACK>	<FUNCTION>	×	×	

# Specifications

Input and output channels	Inputs	Built-in mic (stereo)	1	
		MIC/LINE (mono)	2	
		 /LINE IN	1	
	Outputs	LINE OUT	1	
		Headphones	1	
		Built-in speaker (mono)	1	
Inputs	Built-in mic	90° XY stereo format		
		Directionality	Unidirectional	
		Sensitivity	-42 dB/1 Pa at 1 kHz	
		Maximum sound pressure input	135 dB SPL	
	MIC/LINE (mono)	Connector	XLR/TRS combo jacks × 2 (XLR: 2 HOT, TRS: TIP HOT)	
		Input gain	Adjustment unnecessary (dual A/D converter circuit used)	
		Input impedance	MIC: 3 kΩ or more LINE: 3 kΩ or more	
		Maximum input level	MIC: +4 dBu LINE: +24 dBu	
		Phantom power	+24/+48 V Channel total 10 mA or less	
		Equivalent input noise	-127 dBu or less (IHF-A) with volume display amplification at maximum and 150Ω input	
	 /LINE IN (supports plug-in power)	Connector	Stereo mini jack × 1	
		Input gain	Adjustment unnecessary (dual A/D converter circuit used)	
		Input impedance	2 kΩ or more	
	Outputs	LINE OUT	Connector	Stereo mini jack × 1
			Maximum output level	+1 dBu
			Output impedance	110 Ω or less
		Headphones	Connector	Stereo mini jack × 1
			Maximum output level	20 mW + 20 mW (into 32Ω load)
Output impedance			15 Ω or less	

	Built-in speaker	500mW 8Ω mono speaker
Recorder	Maximum simultaneous recording tracks	4
	Maximum simultaneous playback tracks	4
	Recording formats	WAV 44.1/47.952/48/48.048/96/192 kHz, 32-bit float mono/stereo BWF and iXML formats supported
	Recording media	4–32GB cards compatible with the microSDHC specification 64GB–1TB cards compatible with the microSDXC specification
Display		1.54-inch full-color LCD (240 × 240)
USB	Connector	USB Type-C • Use a USB cable that supports data transfer. USB bus power is supported.
	USB Mic	USB 2.0 High Speed 48 kHz 24-bit/32-bit float 4-in/2-out
	File transfer	USB 2.0 High Speed
Timecode	Connector	3.5mm stereo mini (TIP: input, RING: output)
	Modes	Off, Internal, External
	Frame rate	23.976 ND, 24 ND, 25 ND, 29.97 ND, 29.97 D, 30 ND, 30 D
	Precision	±0.2 ppm
	Allowed input level	0.2 – 5.0 Vpp
	Input impedance	4.6 kΩ
	Output level	3.3 Vpp
	Output impedance	50 Ω or less
REMOTE		Dedicated remote control (ZOOM RC2, RC4, RCH-5 or RCH-6)
Power		4 AA batteries (alkaline, NiMH or lithium) AC adapter (ZOOM AD-17): DC 5 V/1 A • USB bus power is supported.

<p>Estimated continuous operation times using batteries</p> <ul style="list-style-type: none"> <li>• These values are approximate.</li> <li>• Continuous battery operation times were determined using in-house testing methods. They will vary greatly according to use conditions.</li> </ul>	<p>2-track recording (built-in XY mic), 48kHz/32-bit float, phantom power off, no headphones, no line out, timecode off, no remote, display power saving on, display brightness at 60</p>	<p>Alkaline batteries: about 19 hours NiMH batteries (1900 mAh): about 14.5 hours Lithium batteries: about 31 hours</p>
	<p>4-track recording (built-in XY mic with INPUT 1/2), 48kHz/32-bit float, phantom power off, headphones used (33Ω load), no line out, timecode off, no remote, display power saving on, display brightness at 60</p>	<p>Alkaline batteries: about 10 hours NiMH batteries (1900 mAh): about 8.5 hours Lithium batteries: about 18.5 hours</p>
Power consumption	5 W maximum	
Dimensions	70.2 mm (W) × 206.2 mm (D) × 47.0 mm (H)	
Weight (including batteries)	325 g	

Note: 0 dBu = 0.775 Vrms





ZOOM CORPORATION

4-4-3 Kanda-surugadai, Chiyoda-ku, Tokyo 101-0062 Japan

[zoomcorp.com](https://zoomcorp.com)