

# Q8n-4K

Handy Video Recorder

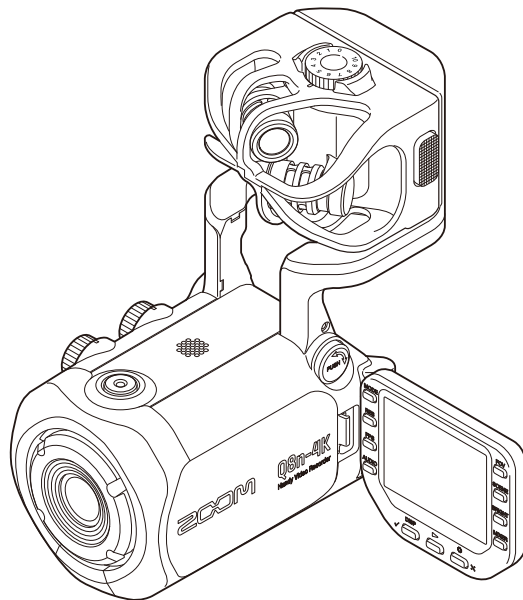

## Operation Manual

You must read the Usage and Safety Precautions before use.

©2022 ZOOM CORPORATION

Copying or reprinting this manual in part or in whole without permission is prohibited.

Product names, registered trademarks and company names in this document are the property of their respective companies. All trademarks and registered trademarks in this document are for identification purposes only and are not intended to infringe on the copyrights of their respective owners.

Proper display is not possible on grayscale devices.

# Notes about this Operation Manual

---

The contents of this document and the specifications of the product could be changed without notice.

- Windows® is a trademark or registered trademark of Microsoft® Corporation.
- iPhone, iPad, iPadOS and Mac are trademarks of Apple Inc.
- App Store is a service mark of Apple Inc.
- iOS is a trademark or registered trademark of Cisco Systems, Inc. (USA).
- Android™ and Google Play are trademarks or registered trademarks of Google LLC.
- The microSDXC logo is a trademark.
- The Bluetooth® word mark and logo are registered trademarks of Bluetooth SIG, Inc. and these marks are used under license by ZOOM CORPORATION.
- The terms HDMI and HDMI High-Definition Multimedia Interface, and the HDMI Logo are trademarks or registered trademarks of HDMI Licensing Administrator, Inc. in the United States and other countries.
- Other product names, registered trademarks and company names in this document are the property of their respective companies.
- All trademarks and registered trademarks in this document are for identification purposes only and are not intended to infringe on the copyrights of their respective owners.
- Recording from copyrighted sources, including CDs, records, tapes, live performances, video works and broadcasts, without permission of the copyright holder for any purpose other than personal use is prohibited by law. ZOOM CORPORATION will not assume any responsibility related to infringements of copyrights.
- The illustrations and display screens in this document could differ from the actual product.



# Contents

---

Notes about this Operation Manual.....	2
Functions of parts.....	6
Back (display closed).....	6
Back (display open).....	7
Left side.....	8
Right side.....	9
Front.....	10
Top.....	11
Bottom.....	12
Preparations.....	13
Installing the battery.....	13
Recharging the battery.....	14
About the mic arm.....	15
Inserting microSD cards.....	16
Turning the power on/off.....	17
Setting up when first turned on (language setting / date and time setting).....	18
Connecting.....	20
Connecting / disconnecting mic capsules.....	20
Connecting mics / instruments / mixers.....	21
Adjusting audio (setting input/output).....	23
Enabling channels to record.....	23
Using phantom power.....	23
Setting phantom power voltage.....	24
Adjusting recording (input) levels.....	25
Using the PAD function.....	26
Mixer Screen.....	27
Reducing noise (low frequency cut).....	28
Setting effects (Comp/Limiter/Gate).....	29
Recording.....	31
Recording Screen.....	31
Selecting a recording mode.....	33
Setting the video recording format.....	34
Setting the audio recording format.....	36
Adjusting the video quality.....	37
Starting recording.....	40
Playing recordings.....	43
Starting playback.....	43
Playback Screen.....	44
Playback operations.....	45
Enabling continuous playback.....	46

Changing the audio channel for playback.....	47
<b>Managing files.....</b>	<b>48</b>
Displaying file information.....	48
Deleting files.....	49
<b>Using USB functions.....</b>	<b>50</b>
Connecting to a computer or iOS/iPadOS device.....	50
Turning the power on when connected to a computer.....	53
Using as a web camera.....	54
Using as a USB mic.....	56
Managing files recorded on the SD card.....	57
<b>Managing SD cards.....</b>	<b>59</b>
Checking SD card information.....	59
Formatting SD cards.....	61
<b>Operating from an iOS/iPadOS/Android device.....</b>	<b>63</b>
Connecting an iOS/iPadOS/Android device.....	63
Disconnecting from the iOS/iPadOS/Android device.....	65
<b>Using connected to a TV / monitor by HDMI.....</b>	<b>66</b>
Checking the Recording Screen on an HDMI-compatible TV / monitor.....	66
Playback on an HDMI-compatible TV / monitor.....	67
<b>Setting the unit.....</b>	<b>69</b>
Setting the volume of the operation sound (Beep).....	72
Enabling Power Saving.....	73
Setting the date and time.....	77
Setting the language shown.....	79
Restoring default settings.....	81
<b>Managing the firmware.....</b>	<b>83</b>
Checking the firmware versions.....	83
Updating the firmware.....	84
<b>Mic capsule information.....</b>	<b>85</b>
Checking mic capsule information.....	85
Using optional mic capsules.....	87
Using the XAH-8.....	88
Using the VRH-8.....	89
Using the XYH-6.....	92
Using the XYH-5.....	93
Using the MSH-6.....	95
Using the SSH-6.....	96
Using the SGH-6.....	97
Using the EXH-6.....	98
<b>Troubleshooting.....</b>	<b>100</b>
There is no sound or output is very quiet.....	100
Recorded sound cannot be heard or is very quiet.....	100
Recording audio/video is not possible.....	100
The recorder becomes warm.....	100

A "Low Speed Card!" warning appears frequently / Stopping recording takes a very long time.....	101
Charging is slow or not possible.....	101
Computer does not recognize it even though it is connected to a USB port.....	101
A channel keeps blinking on the Recording Screen.....	101
Specifications.....	102

# Functions of parts

## Back (display closed)

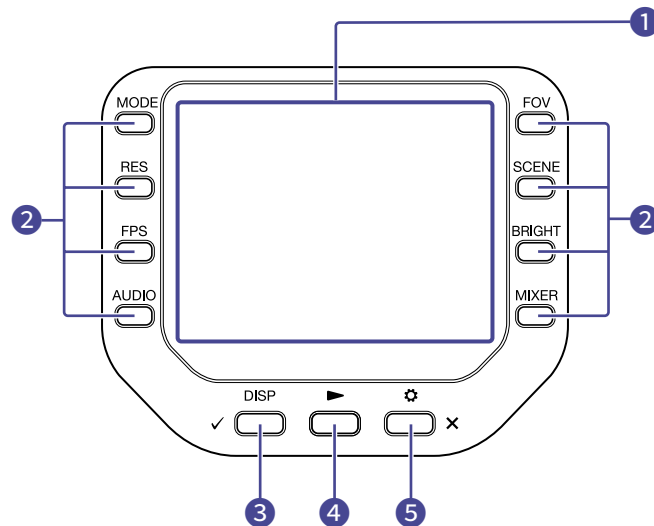

- 1 Display (LCD)**  
This shows the video and various types of information.
- 2 Function buttons**  
Use these to operate the functions shown on the display.
- 3 DISP/Check button**  
Change what is shown on the Recording Screen and Playback Screen. Use this to confirm operations on confirmation screens.
- 4 Play button**  
Use this to play files recorded by the Q8n-4K.
- 5 Settings/Exit button**  
Use this to open and close the SETTINGS Screen, for example. Use this to cancel on setting and confirmation screens.

## Back (display open)

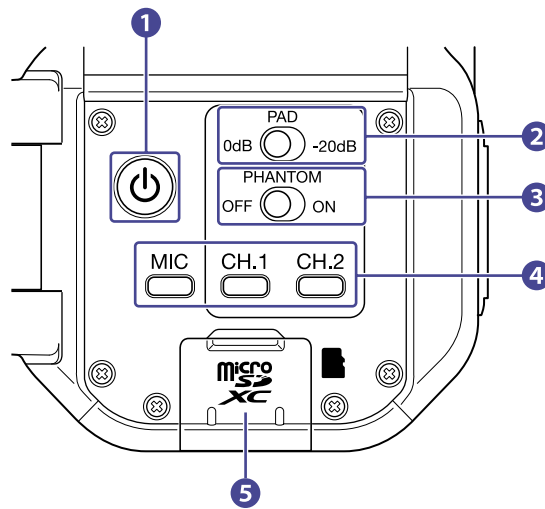

- 1 Power button**  
This turns the power on/off.
- 2 PAD switch**  
This attenuates the input signals of equipment connected to Inputs 1/2 by 20 dB.
- 3 PHANTOM switch**  
This turns Input 1/2 phantom power ON/OFF.  
The phantom power voltage can be set to +12 V / +24 V / +48 V. (→ [Using phantom power](#))
- 4 Channel buttons**  
These turn each channel on/off.
- 5 microSD card slot**  
Insert a microSD card here.

## Left side

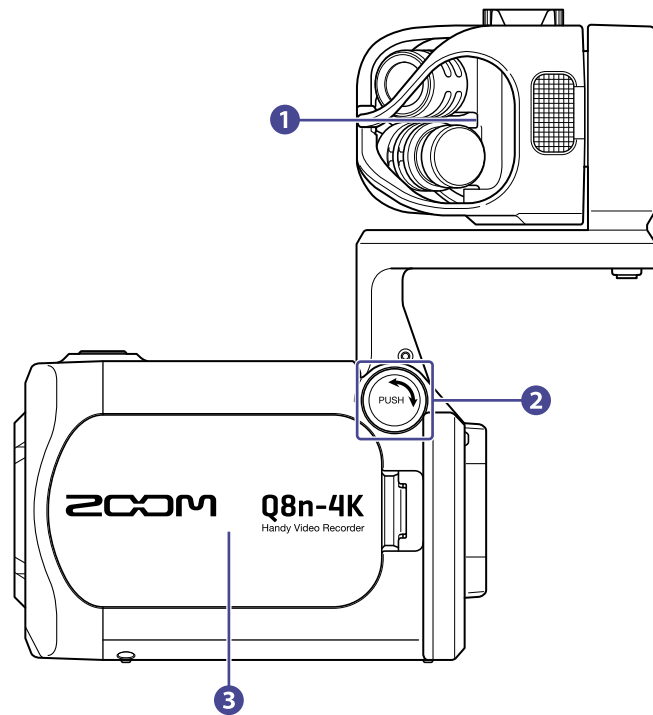

**1** Mic capsule

Other mic capsules can be swapped for different applications.

**2** UNLOCK button

Press in to enable moving the mic arm.

**3** Battery cover

Remove this when installing or removing a battery.



## Right side

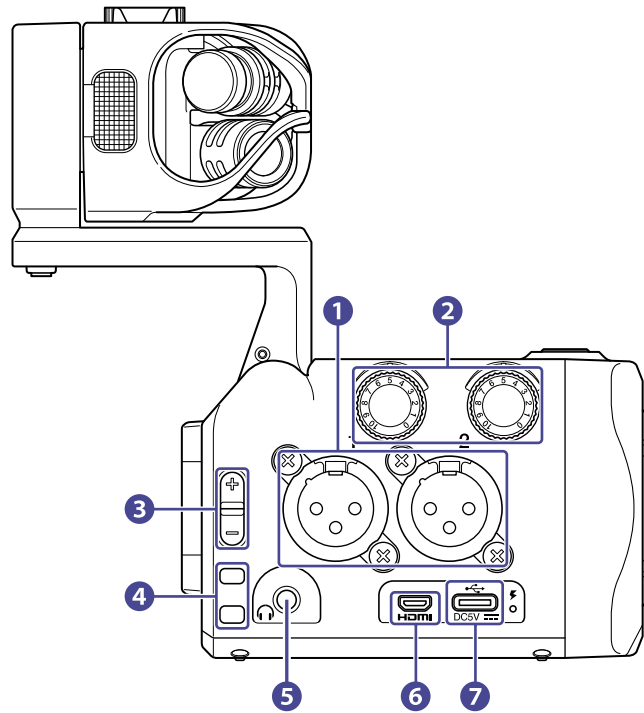

### 1 Inputs 1/2

Connect mics and instruments to these. These can be used with XLR plugs.

### 2 Input volume 1/2

These adjust input volumes.

### 3 Output volume

This adjusts output volume.

### 4 Strap holes

Use these to attach a strap.

### 5 Headphone output jack

This can output sound to headphones.

### 6 Micro HDMI port

This can output video and audio to an HDMI-compatible TV or other device.

### 7 USB (Type-C) port

Connect this to a computer or iOS/iPadOS device to use the Q8n-4K as a web camera, card reader or USB mic.

A dedicated AC adapter (ZOOM AD-17) can also be connected here to use AC power. Connecting this when the power is off will charge the battery.

## Front

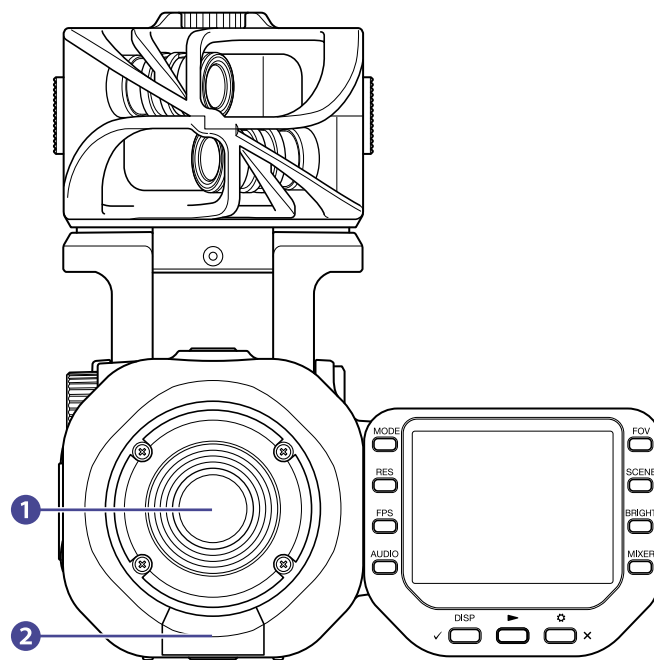

### 1 Lens

This lens has F2.8 brightness and a 150° wide angle.

### 2 REMOTE connector

Connect a BTA-1 or other dedicated wireless adapter here. This enables operation of the Q8n-4K from an iOS/iPadOS/Android device using a dedicated controller app.

# Top

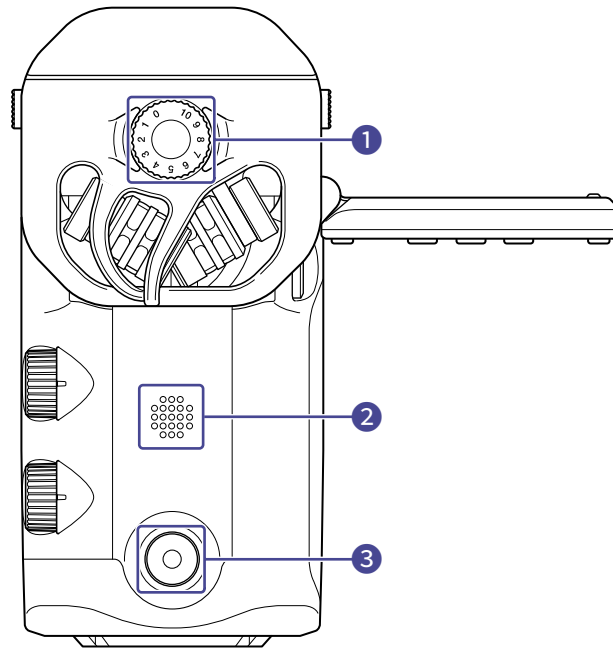

- 1 Mic input volume**  
This adjusts the mic input volume.
- 2 Speaker**  
This outputs the sound of files and the beep.
- 3 Record button**  
This starts and ends recording video/audio.

## Bottom

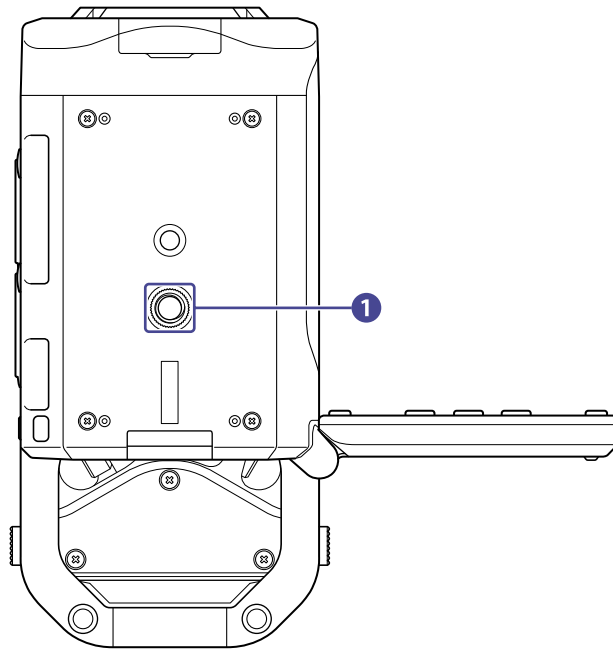

### 1 Tripod mounting threads

Use these screw threads to attach a tripod (not included).

# Preparations

---

## Installing the battery

1. Turn the power off, and open the battery cover while pressing the latch.

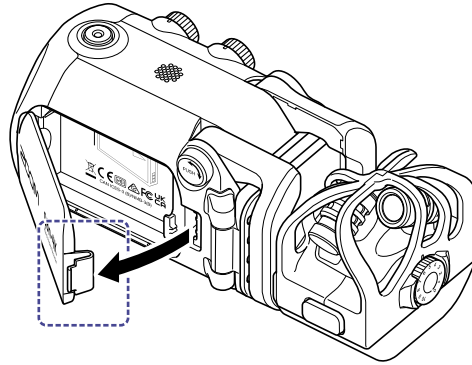

2. Install the rechargeable battery.

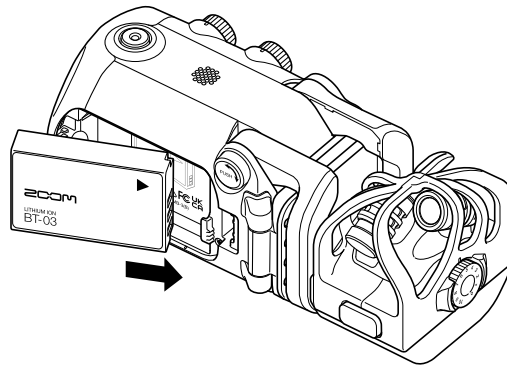

3. Close the battery cover.

# Recharging the battery

1. Turn the Q8n-4K off.
2. Connect a USB power supply (running computer or ZOOM AD-17 AC adapter).

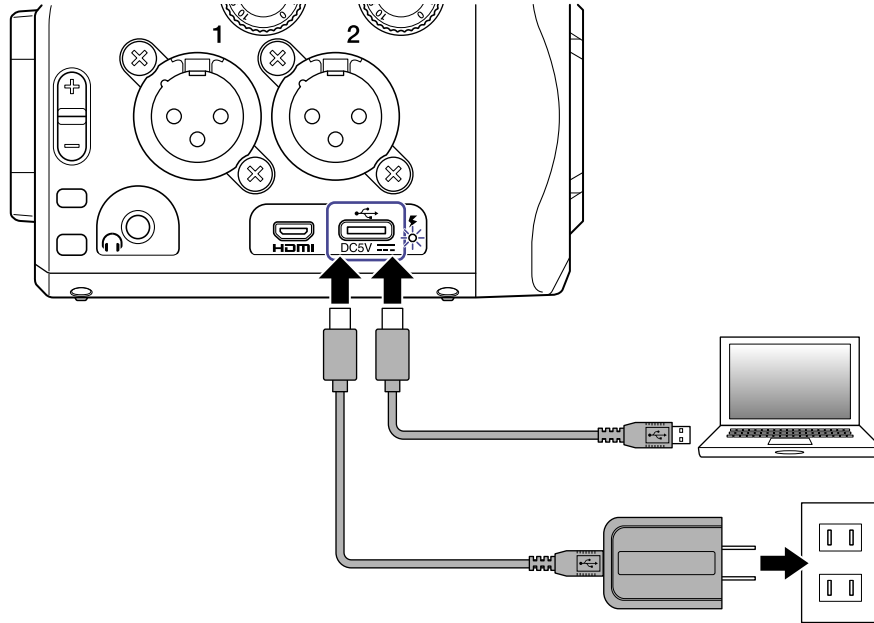

While the battery is charging, the charging LED will stay lit.

3. When charging is complete, disconnect the cable from the USB power supply. After charging has completed, the charging LED will become unlit.

## NOTE:

- The battery will not charge when the power is on.
- The ambient temperature should be between 5°C and 35°C when charging. Charging at other temperatures can cause the battery to overheat, break or deteriorate.
- Do not leave the cable connected for a long time after charging is complete.
- In addition, regarding battery use, follow the instructions in Precautions for Li-ion battery.

## About the mic arm

### Raising the mic arm

---

While pressing , raise the mic arm until it reaches the fixed position.

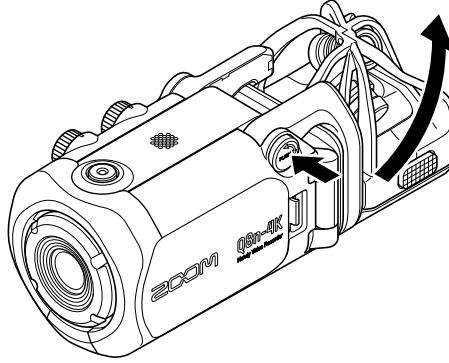

### Lowering the mic arm

---

While pressing , lower the mic arm.

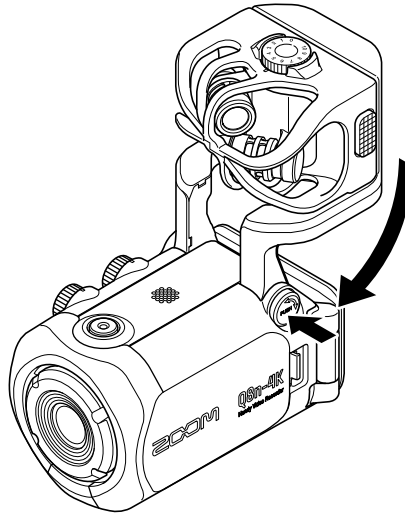

# Inserting microSD cards

1. Turn the power off and open the microSD card slot cover.

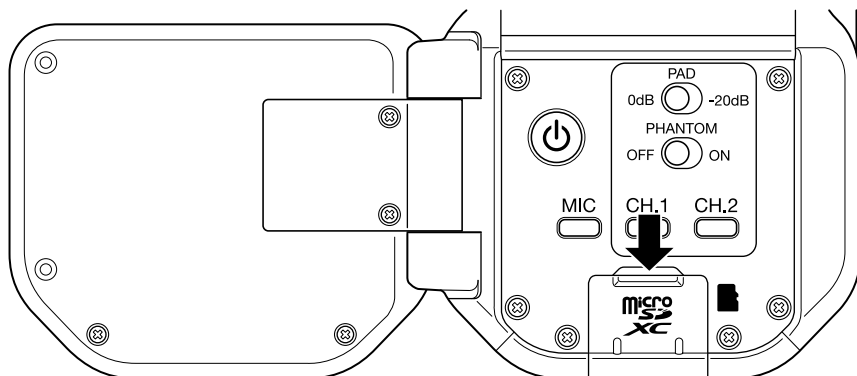

2. Insert a microSD card into the card slot.

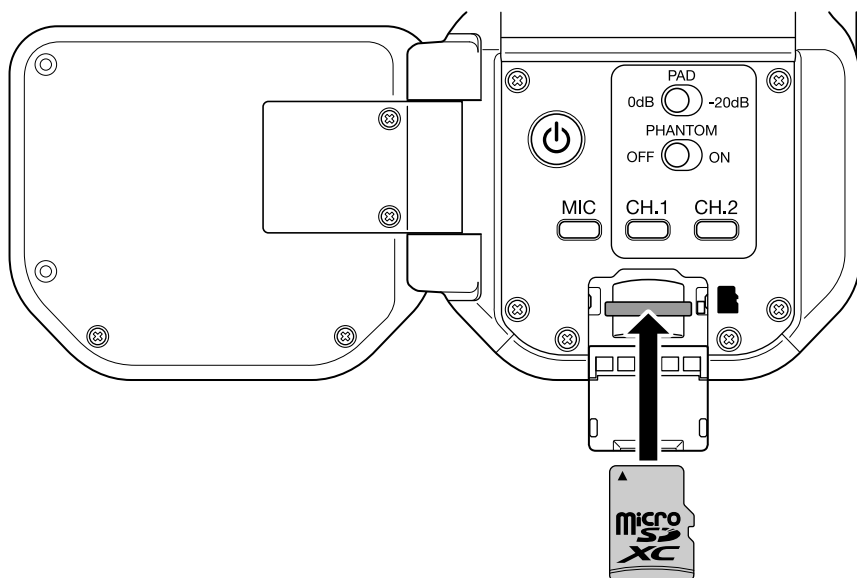

To remove a microSD card, push it further into the slot and then pull it out.

## NOTE:

- Supported recording media  
microSDHC: 4 GB – 32 GB  
microSDXC: 64 GB – 512 GB
- Use a microSD card that is Class 10 or higher.  
When recording at 4K resolution, use a microSD card that is UHS Speed Class 3 or higher.
- When recording for long periods of time with a microSDHC card, recording files will be split every 4 GB.  
When using a microSDXC card, recording to a single file is possible even if the file size exceeds 4 GB.



# Turning the power on/off

## Turning the power on

1. Open the display (LCD).
2. Press .

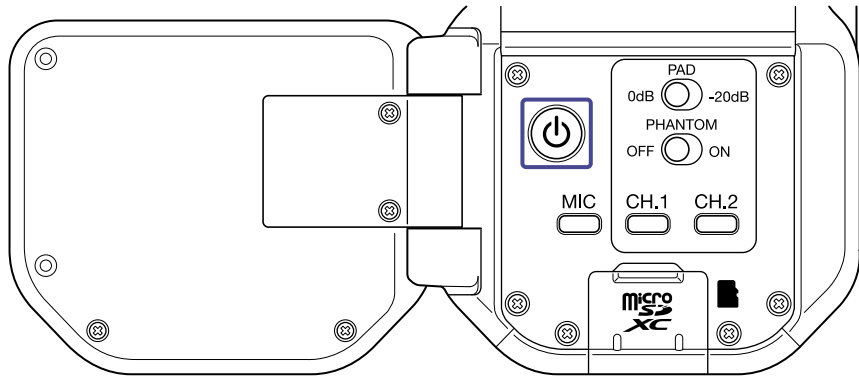

## Turning the power off

1. Press and hold .

After "Goodbye See You !" is displayed, the power turns off.

**NOTE:**

When Auto Power Off is set to on, the power will be turned off automatically after a certain period of time.

# Setting up when first turned on (language setting / date and time setting)

Language setting / date and time setting screens automatically appear when first turned on or when first turned on after being reset.

1. Turn the power on.  
The Language Screen opens.

2. Use  and  to select the language.

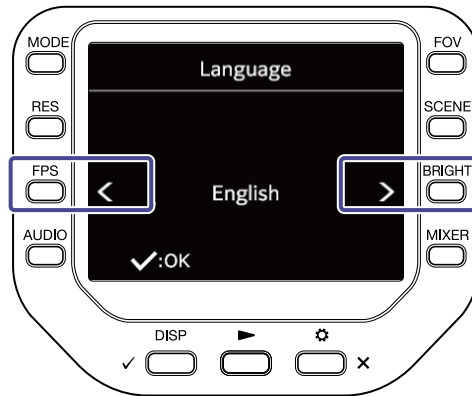

3. Press .

The language is set and the SET DATE Screen opens.

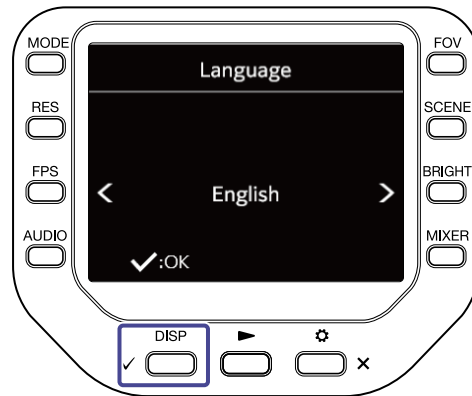

4. Press the corresponding  to change the date and time.

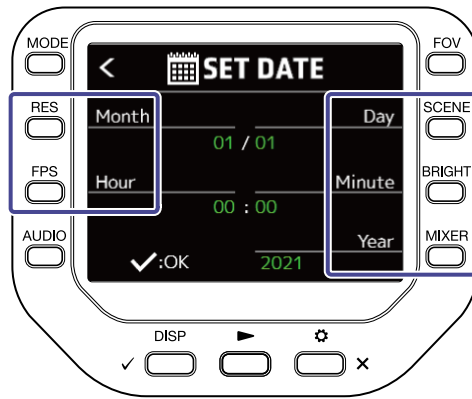

5. Press .

The date and time are set and the Recording Screen opens.

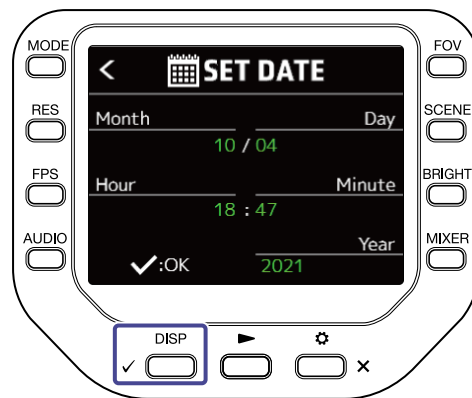

**NOTE:**

If four minutes or more have passed with the battery removed while the power is off, the date and time setting could be reset.

# Connecting

## Connecting / disconnecting mic capsules

### Connecting mic capsules

Push a mic capsule into place until it locks.

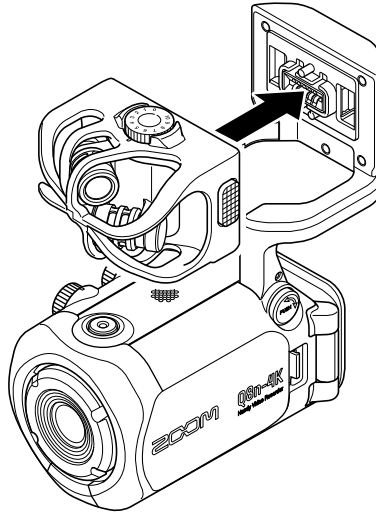

### Disconnecting mic capsules

While pressing the buttons on the left and right sides of the mic, pull it out of the unit.

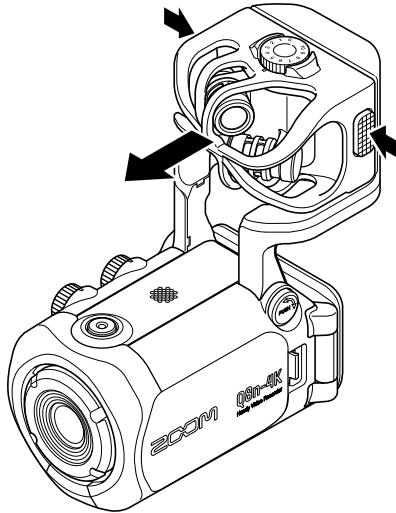

#### NOTE:

- Do not use too much force when disconnecting. Doing so could damage the mic capsule and the unit.
- Recording will stop if a mic capsule is removed during recording.

# Connecting mics / instruments / mixers

You can connect mics, mixers, and other instruments to Inputs 1 and 2 of the Q8n-4K. The L/R input from the mic capsule and Inputs 1/2 can be used together to record up to 4 channels at the same.

## Concert video recording

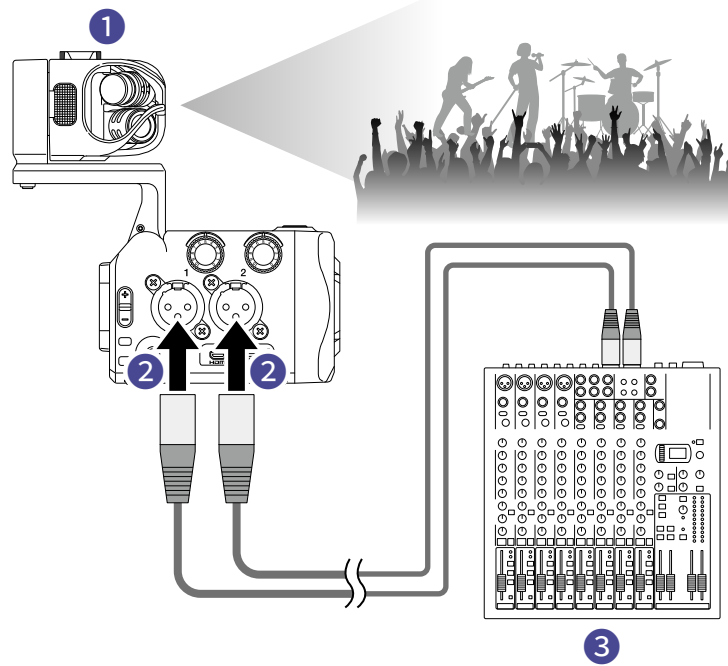

### 1 L/R input

This records the sound of the entire concert hall.

### 2 Inputs 1/2

Connect to the line outputs from the PA mixer to record the clear sound of instruments and vocals.

### 3 PA mixer

# Guitar performance video recording

---

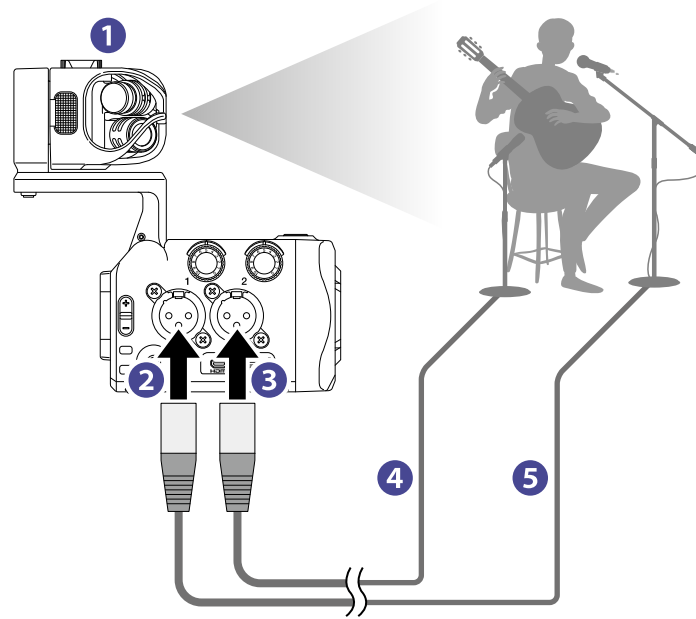

**1** L/R input

This records the sound of the room where vocals and guitar are combined.

**2** Input 1

Connect to a vocal mic to record a clear singing voice.

**3** Input 2

Connect to a guitar mic to record clear sound.

**4** Guitar mic

**5** Vocal mic

---

**HINT:**

Phantom power (+12 V / +24 V / +48 V) can be supplied to condenser mics.

---

# Adjusting audio (setting input/output)

## Enabling channels to record

1. Press the channel buttons of the channels that you want to record.

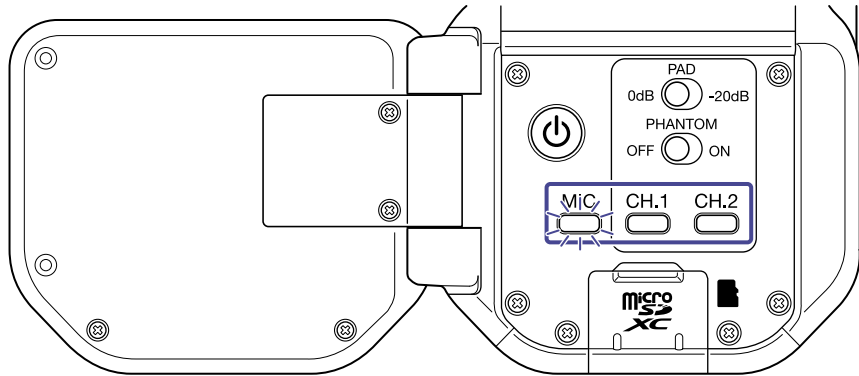

The button indicators for the selected channel buttons light red and you will be able to monitor the signals input on these channels through the Headphone output.

2. To record Inputs 1/2 as a stereo file (stereo link), press **CH.1** and **CH.2** at the same time.

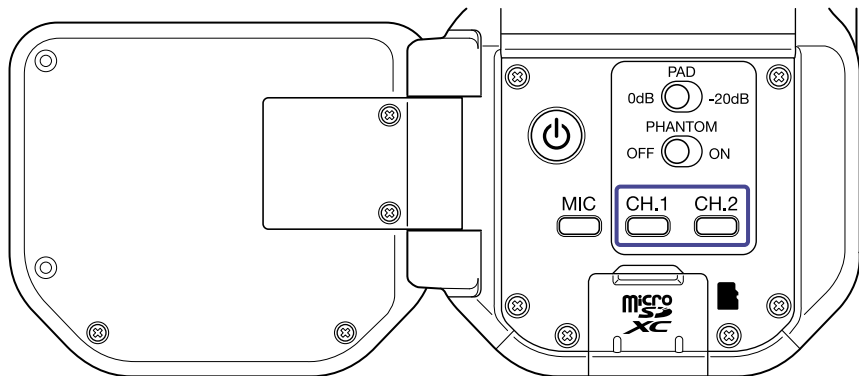

To end the stereo link, press **CH.1** and **CH.2** at the same time again.

## Using phantom power

Inputs 1/2 support phantom power. They can supply power at +12 V / +24 V / +48 V.

To turn phantom power on, slide <sup>PHANTOM</sup> to the ON side.

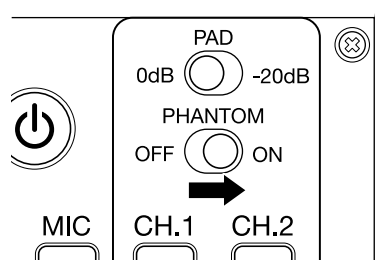

# Setting phantom power voltage

1. Press  on the Recording Screen.  
The SETTINGS Screen opens.



2. Press  SYSTEM on the SETTINGS Screen.  
The SYSTEM Screen opens.

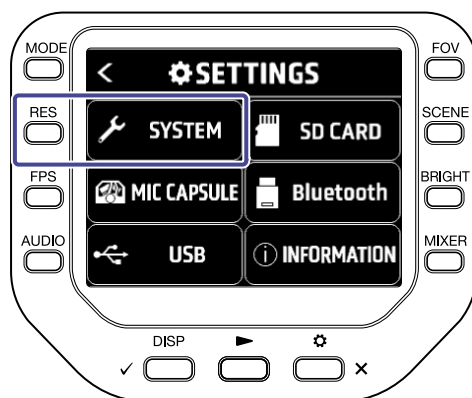

3. Press "PhantomVoltage".

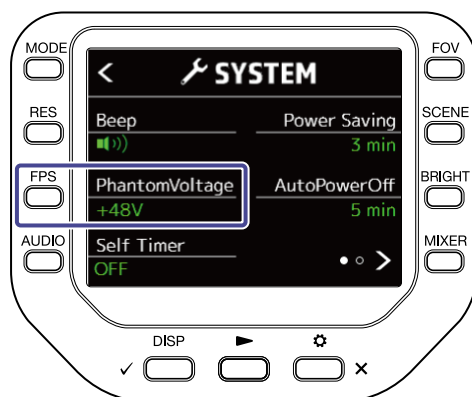





# Adjusting recording (input) levels

## When using a mic capsule

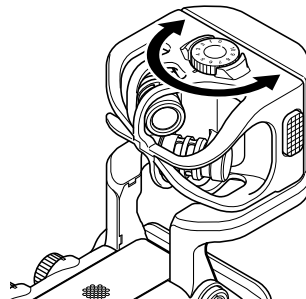
Turn .



## When using Inputs 1/2

Turn  on the right side of the unit.

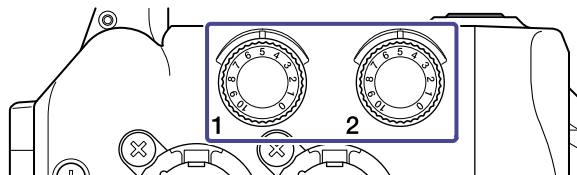

### HINT:

If an input clips, the button indicator for the channel button will blink. Adjust the level so that the indicator does not blink even when loud sounds are input.

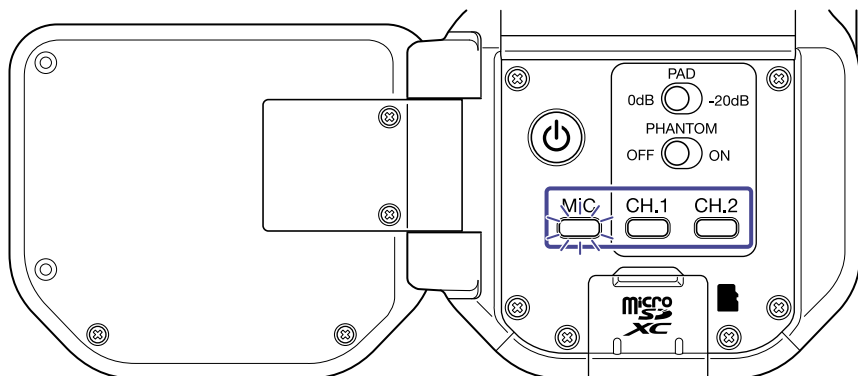

## Using the PAD function

Turn the PAD function on by sliding  to the -20dB side to allow connection of mixers and other devices with a rated output level of +4 dB.

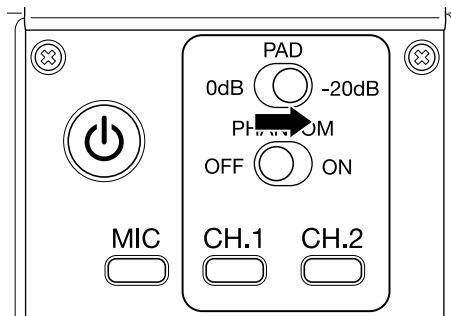







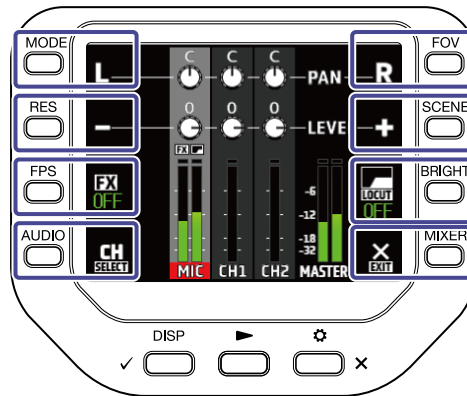

# Mixer Screen

1. Press  on the Recording/Recording Standby Screen, Webcam Screen, or USB Mic Screen. The Mixer Screen opens.



2. Press  to set. On the Mixer Screen, you can set PAN / LEVEL / FX / LOCUT for each channel.



Button	Explanation
	Pan the sound to the left.
	Pan the sound to the right.
	Lower the volume.
	Raise the volume.
	Set effects.
	Reduce noise.
	Change the selected channel.
	Exit the Mixer Screen.

**NOTE:**

The Mixer Screen cannot be displayed during recording / web camera use.

## Reducing noise (low frequency cut)

You can reduce the sound of wind, vocal pops and other noise.

1. Press  on the Mixer Screen to select a channel.

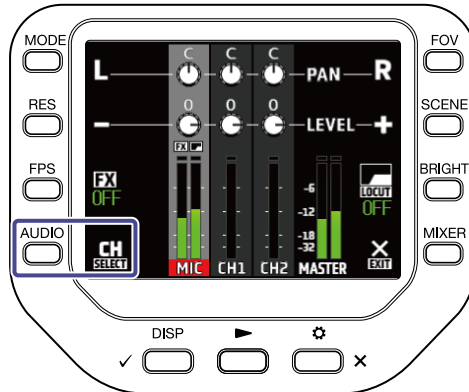

2. Press  to select a setting.

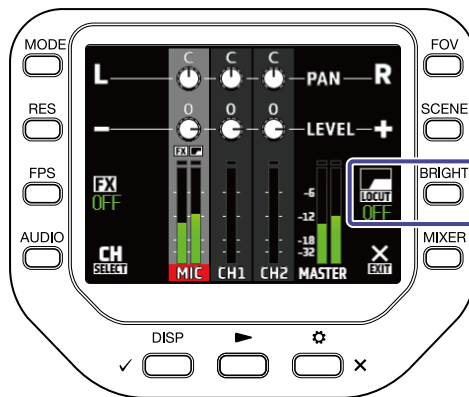

Setting	Explanation
OFF	Low-frequency noise reduction is disabled.
80Hz	Cut audio below 80 Hz.
120Hz	Cut audio below 120 Hz.
160Hz	Cut audio below 160 Hz.
200Hz	Cut audio below 200 Hz.
240Hz	Cut audio below 240 Hz.

## Setting effects (Comp/Limiter/Gate)

You can record clearer sound by adjusting the volume according to the input signal level.

1. Press **CH SELECT** on the Mixer Screen to select a channel.

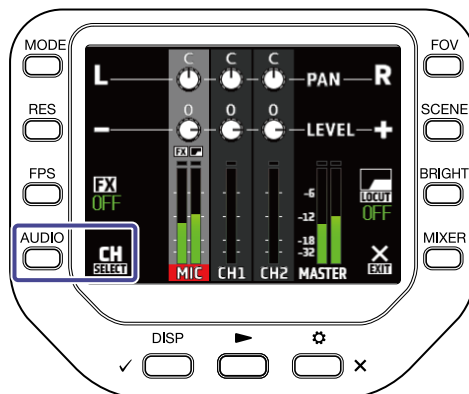

2. Press **FX** to select a setting.

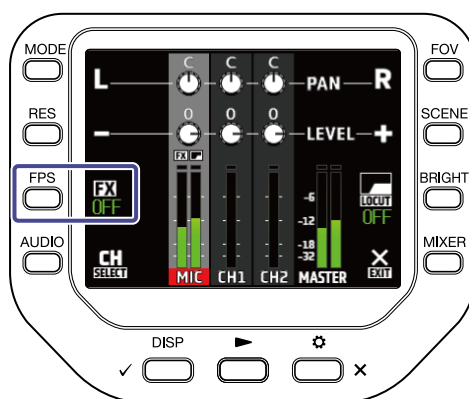

Setting	Explanation
OFF	Effects are disabled.
Compressor (Comp)	This raises low-level sounds and compresses high-level sound. When recording bands, for example, this can increase the sound pressure, which increases the impact of the audio.
Limiter	This keeps the volume below a certain level to prevent the sound from being distorted.
Leveler	This automatically adjusts the recording volume to keep it at a certain level when input sound level is low. This is effective when the volume differences are great, such as when an MC speaks between concert performances.
De-esser (DeEss)	This makes voices sound better by suppressing sibilants such as "s" sounds in conversations.

Setting	Explanation
Noise Gate (Gate)	When the input is below a certain level, this suppresses background noise.

# Recording

## Recording Screen

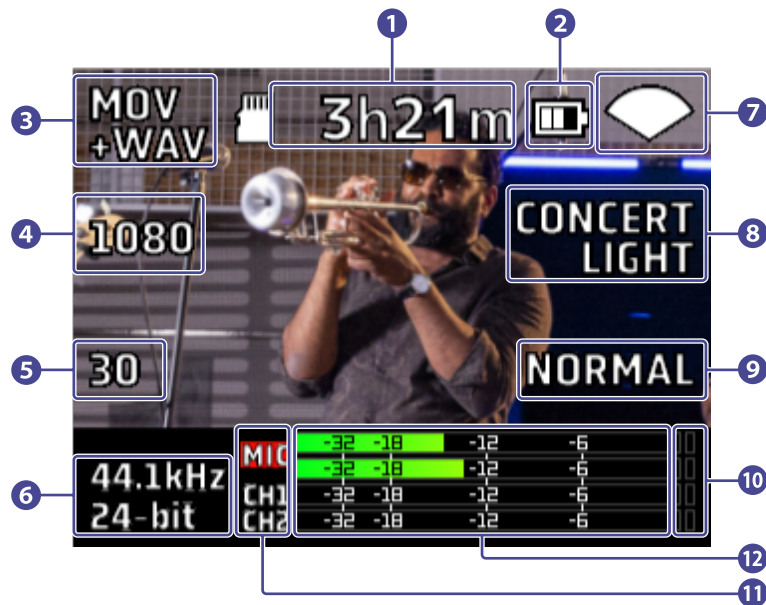

- 1 Available recording time**  
This shows the available recording time.
- 2 Remaining battery level**  
This shows the remaining battery level. When the remaining battery level is low, charge the battery or connect the AC adapter.
- 3 Recording mode**  
This shows the current recording mode.
- 4 Resolution**  
This shows the current resolution.
- 5 Frame rate**  
This shows the current frame rate.
- 6 Recording format**  
This shows the current recording format.
- 7 Field of view**  
This shows the current field of view.
- 8 Scene setting**  
This shows the current scene setting.

**9** Brightness

This shows the current brightness.

**10** Clip indicators

If a clip indicator lights, adjust the input level or Mixer level, or set the Limiter.

**11** Channels

These show the ON/OFF status of each channel. If a channel blinks, adjust the input level.

**12** Level meters

These show the level (post fader) of each channel.



# Selecting a recording mode

You can change the recording mode on the Recording Screen.

1. Press  on the Recording Screen.



Setting	Explanation
MOV	Record as MOV files containing both video and stereo audio.
MOV+WAV	WAV files are saved separately for each channel in addition to MOV files.
WAV(STEREO)	Stereo audio is saved as WAV files.
WAV(MULTI)	Stereo audio and audio for each channel are separately saved as WAV files.

File name	Explanation	Recording mode			
		MOV	MOV +WAV	WAV (STEREO)	WAV (MULTI)
ZOOMXXXX.MOV	A MOV file with recorded video and stereo audio	✓	✓		
ZOOMXXXX.WAV	A stereo WAV file with recorded audio			✓	✓
ZOOMXXXX_MIC.WAV	A stereo WAV file with recorded audio from the mic capsule		✓		✓
ZOOMXXXX_INPUT1.WAV	A mono WAV file with recorded audio from Input 1		✓		✓
ZOOMXXXX_INPUT2.WAV	A mono WAV file with recorded audio from Input 2		✓		✓
ZOOMXXXX_INPUT12.WAV	A stereo WAV file with recorded audio from stereo-linked Inputs 1/2		✓		✓

**NOTE:**

The WAV file for each channel is a recording of audio that is not affected by the Mixer PAN / LEVEL / FX / LOCUT settings.

## Setting the video recording format

### Setting the resolution

1. Press  to change the resolution.



Setting	Resolution	Explanation	File size
4K	3840 x 2160	Use when video quality is the top recording priority.	Large ↕ Small
1080	1920 x 1080	This is suitable for all kinds of video recording.	
720	1280 x 720	This is suitable for long-time recording.	

**NOTE:**

4K and 60 fps / 50 fps cannot be selected at the same time. Select 4K and 30 fps when giving priority to video quality or select 1080 and 60 fps when giving priority to frame rate.

## Setting the frame rate

1. Press  to change the frame rate.



Setting	Frame rate	Explanation
60	60 fps	This is suitable for recording a fast-moving subject or recording smooth-moving video.
50	50 fps	
30	30 fps	This is the standard frame rate.
25	25 fps	
24	24 fps	This is suitable for recording movies and music videos.

# Setting the audio recording format

You can change the audio recording format on the Recording Screen.

1. Press  on the Recording Screen.



Setting	Explanation
96kHz/24-bit	The higher the sampling frequency (kHz) and bit rate are set, the better the audio quality will be.
96kHz/16-bit	
48kHz/24-bit	
48kHz/16-bit	
44.1kHz/24-bit	
44.1kHz/16-bit	

**NOTE:**

When MOV+WAV or WAV (MULTI) is selected for the recording mode, 96 kHz cannot be selected.





# Adjusting the video quality

You can adjust the video quality on the Recording Screen.

## Adjusting the field of view

1. Press  on the Recording Screen.



Setting	Explanation
 WIDE	This widens the field of view.
 .	↑
 ●	Standard
 .	↓
 TELE	This narrows the field of view.

# Selecting a scene

1. Press  on the Recording Screen.



Setting	Explanation
AUTO	Settings change according to the recording conditions.
INDOOR	Settings are optimized for indoor recording.
OUTDOOR	Settings are optimized for outdoor recording.
CONCERT LIGHT	Settings are suitable for concert lighting that is bright and changes drastically.
NIGHT	Settings are suitable for night and other dark situations.

# Adjusting the brightness

1. Press  on the Recording Screen.





Setting	Explanation
HIGH	Bright
NORMAL	Standard
LOW	Dark

# Starting recording

1. Press  on the Recording Screen.

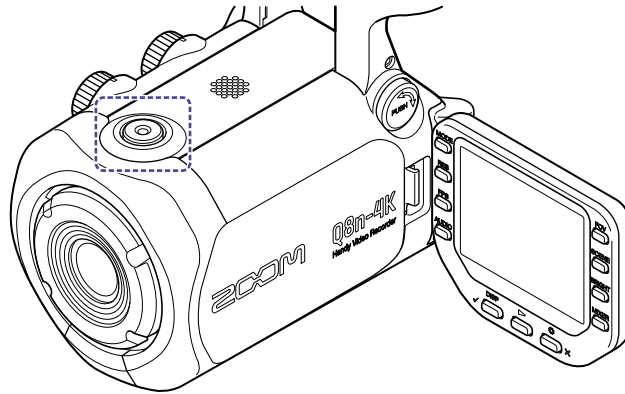
Recording starts.



Press  again to stop recording.

## NOTE:

During recording, only the Field of view (FOV) and the brightness (BRIGHT) settings can be changed. To change other settings or open the Mixer Screen, stop recording.



# Using the Self Timer function

You can set the Self Timer on the SYSTEM Screen.

1. Press  on the Recording Screen.  
The SETTINGS Screen opens.





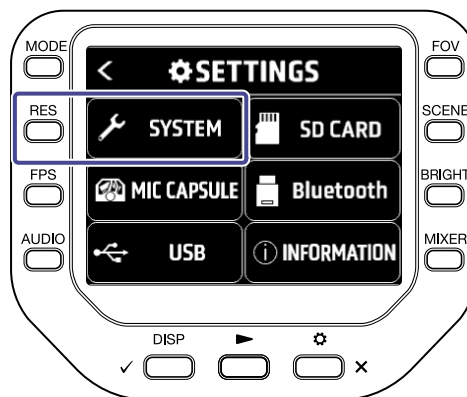

2. Press  on the SETTINGS Screen.  
The SYSTEM Screen opens.





### 3. Press "Self Timer".



Setting	Explanation
OFF	Start recording right after pressing  .
3 sec	Start recording 3 seconds after pressing  .
5 sec	Start recording 5 seconds after pressing  .
10 sec	Start recording 10 seconds after pressing  .

**HINT:**

By pressing  during the countdown, you can start recording immediately.

By pressing   during the countdown, you can interrupt it and cancel the self timer.

# Playing recordings

## Starting playback

1. Press  on the Recording Screen.

Playback of the last recorded file or last played file will start.



To stop playback and return to the Recording Screen, press  x.

### NOTE:

Only video and audio files recorded with the Q8n-4K can be played back.

# Playback Screen

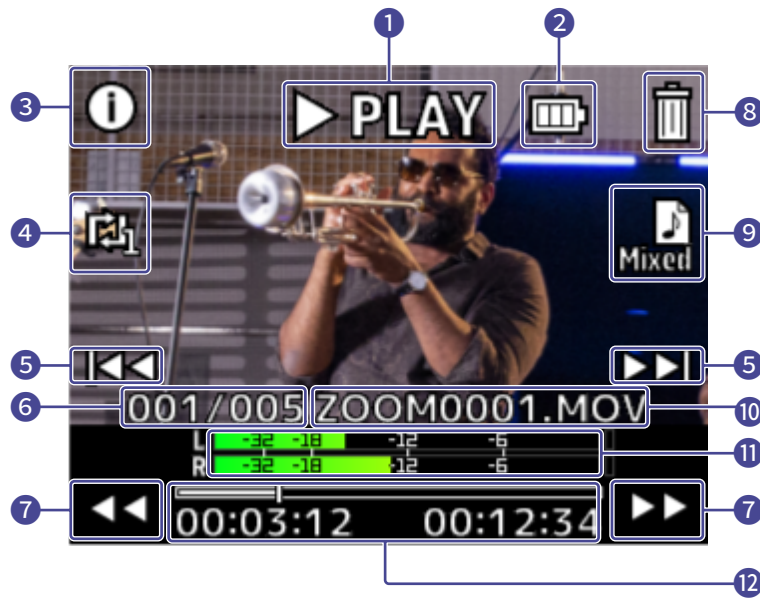

## 1 Playback status

This shows the current playback status.

## 2 Remaining battery level

This shows the remaining battery level. When the remaining battery level is low, charge the battery or connect the AC adapter.

## 3 File information

This shows information about the playing file.

## 4 Repeat setting

Change the repeat setting.

## 5 File selection

Select a file to play back.

## 6 File number

This shows the file number being played back / total number of files.

## 7 Playback position search

Search backward and forward for the playback position.

## 8 File deletion

Delete a file being played back.

## 9 Audio channel selection

Select the audio channel to play back.

## 10 File name

This shows the name of the file being played back.

### 11 Level meters

These are the level meters for the audio from the selected channels.

### 12 Playback position

This shows the current playback position, elapsed time, and video length.

**NOTE:**

After a certain period of time from the start of playback, icons will automatically disappear from the previous screen. If you want to show them again, press   <sup>DISP</sup>.

## Playback operations

The following operations are possible during playback.



Button	Explanation
⏩	Skip 10 seconds forward. Press and hold to search forward.
⏪	Skip 10 seconds backward. Press and hold to search backward.
⏭	Skip to the next file.
⏮	Skip to the previous file.
⏸	Pause / resume playback.

**NOTE:**



When the length of the file to be played back is no more than one minute, pressing ⏩ / ⏪ skips one second forward / back one second.

# Enabling continuous playback

Continuous playback can be set on the Playback Screen.

1. Press  on the Playback Screen.



Setting	Explanation
 REPEAT OFF	After one file completes playing back, it returns to the beginning of the file and playback stops.
 REPEAT ONE	After one file completes playing back, it returns to the beginning of the file and repeats playback.
 REPEAT ALL	After one file completes playing back, the next file plays back without stopping. The files are played back in the order of recorded time. After the latest file is played back, the first file will be played back continuously.

# Changing the audio channel for playback

When playing a file recorded in MOV+WAV or WAV (MULTI) format, you can change the audio channel for playback on the Playback Screen.

1. Press  on the Playback Screen.



Setting	Explanation
<b>Mixed</b> MIXED	Plays back the audio recorded with MIC, CH1 and CH2 and adjusted by the Mixer.
<b>MIC</b> MIC	Plays back the audio recorded with the mic capsule.
<b>CH1</b> CH1	Plays back the audio recorded with Input 1.
<b>CH2</b> CH2	Plays back the audio recorded with Input 2.
<b>1/2</b> CH1/CH2	Plays back the audio recorded with stereo-linked Inputs 1/2.

# Managing files

## Displaying file information

File information can be shown on the Playback Screen.

1. Press **i** on the Playback Screen.

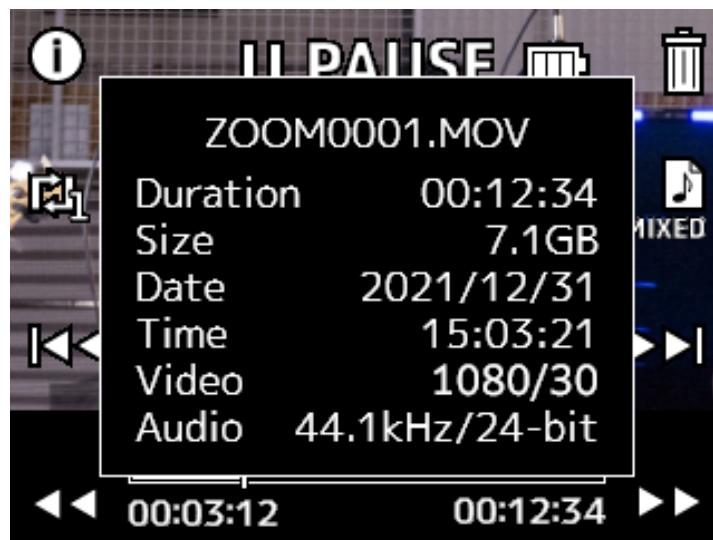

Press any button to return to the Playback Screen.



# Deleting files

You can delete files that are playing back or stopped on the Playback Screen.

1. Press  on the Playback Screen.

The Deletion confirmation screen opens



2. Press  <sup>DISP</sup> to delete the file.



To cancel the deletion, press  <sup>DISP</sup> x.

# Using USB functions

## Connecting to a computer or iOS/iPadOS device

Use a USB cable to connect to a computer or iOS/iPadOS device and use the Q8n-4K as a web camera, card reader or USB mic.

1. Press  on the Recording Screen.



The SETTINGS Screen opens.

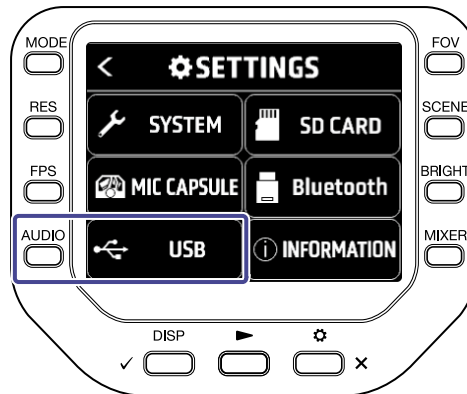

2. Press  .

The USB Screen opens.



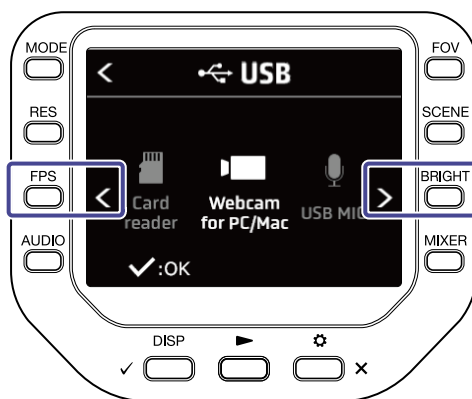

3. Press  or  to select the function to use.

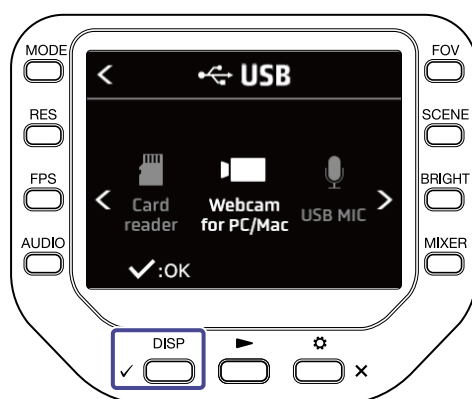

4. Press  .



If you select "Card reader" or "USB MIC", go to step 5.  
If you select "Webcam for PC/Mac", go to step 7.

5. Press  or  to select the device to connect.

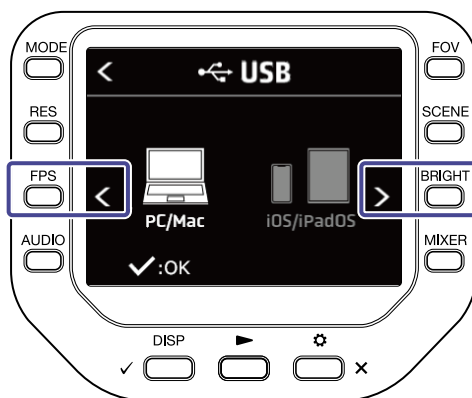

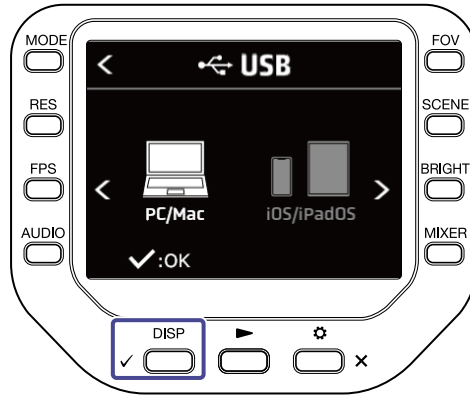

6. Press .



If you select "PC/Mac", go to step 7.

If you select "iOS/iPadOS", go to step 9.

7. Press  or  to select the power supply.

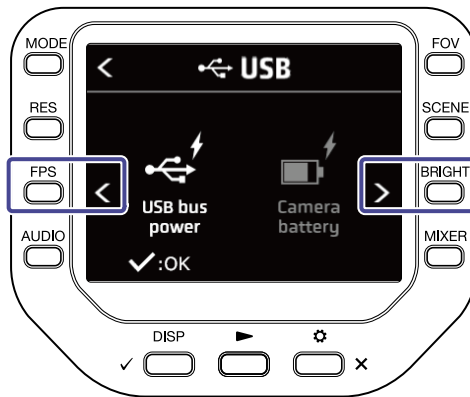

8. Press .

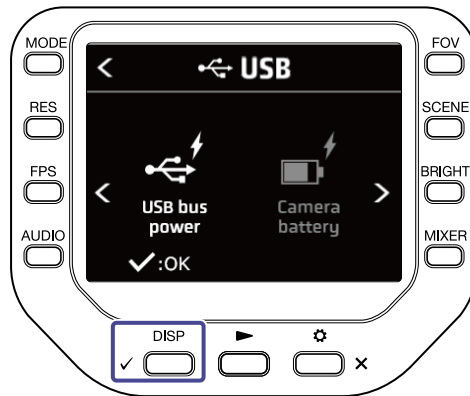

9. Connect a computer or iOS/iPadOS device with a USB cable.

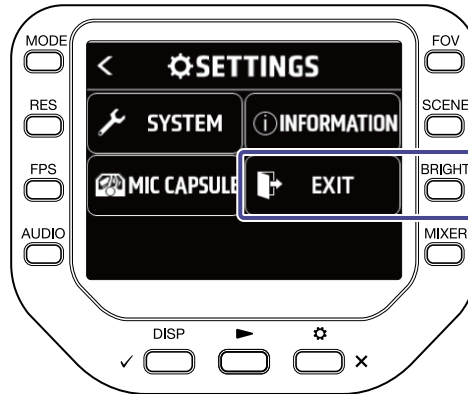

**10.** To end use, press  **EXIT** on the SETTINGS Screen.



## Turning the power on when connected to a computer

The USB setting Screen will appear.

You can use a USB function by selecting the corresponding item.

To open the Recording Screen, press  or  x.

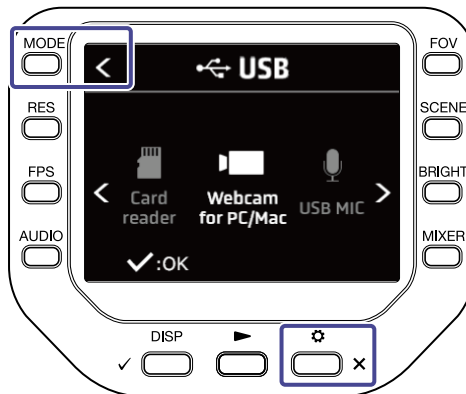

## Using as a web camera

You can use the Q8n-4K as a web camera to output audio and video signals to a computer.

1. Connect the Q8n-4K to a computer.

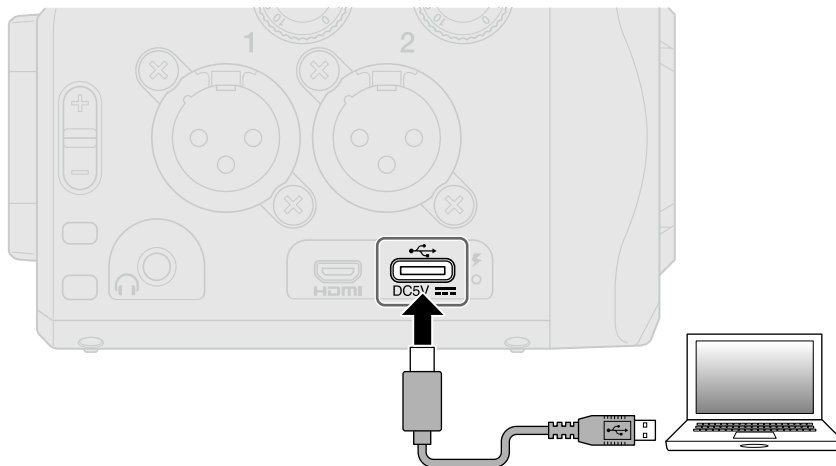

**NOTE:**

Web camera use is not possible with an iOS/iPadOS device.

2. Launch an application that uses a camera on the computer, and select the Q8n-4K.

**NOTE:**

The Q8n-4K can simultaneously transmit video and audio with resolutions up to 1080 p HD and 48 kHz/16-bit to a computer

The Q8n-4K cannot output computer playback signals.

3. To end the connection, conduct the necessary disconnection procedures on the computer.

# Compensating for lags between video and audio

If a timing difference occurs between the video and audio when using the recorder as a web camera, you can set an audio delay time so that it matches the timing of the video.

1. During web camera use, press **DELAY**.



2. Press **+10ms** or **-10ms** to adjust the delay time.



Pressing **+10ms** lengthens the delay time by +10 ms and pressing **-10ms** shortens the delay time by -10 ms.

Setting	Explanation
0 ms	The delay time can be set in increments of 10 ms. The maximum delay time is 300 ms.
↕	
300 ms	

# Using as a USB mic

The Q8n-4K can be used as a USB mic to input audio to a computer or iOS/iPadOS device.

1. Connect the Q8n-4K to a computer or iOS/iPadOS device with a USB cable (Type-C).

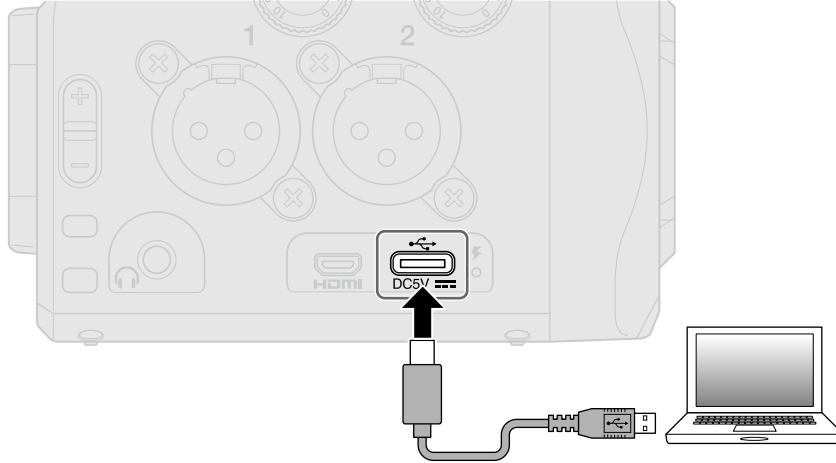

2. Launch an application that uses a mic on the computer or iOS/iPadOS device, and select the Q8n-4K.
3. To end the connection, conduct the necessary disconnection procedures on the computer or iOS/iPadOS device.

## Enabling direct monitoring

The input sound can be monitored directly during web camera use or USB mic use.

1. During web camera use or USB mic use, press **DIRECT MONITOR**.

Direct monitoring is turned ON/OFF.





# Managing files recorded on the SD card.

The Q8n-4K can be used as a card reader to read and write data from computers and iOS/iPadOS devices.

1. Connect the Q8n-4K to a computer or iOS/iPadOS device with a USB cable (Type-C).

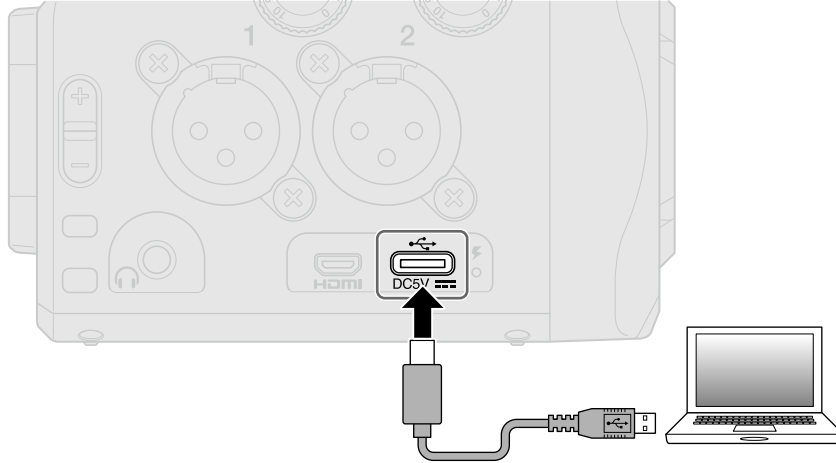

2. Open a file management screen on the computer or iOS/iPadOS device and show the contents of the microSD card in the Q8n-4K.
3. Work with the files on the microSD card.
4. To end the connection, conduct the necessary disconnection procedures on the computer or iOS/iPadOS device.

5. Press  x.  
The SETTINGS Screen opens.

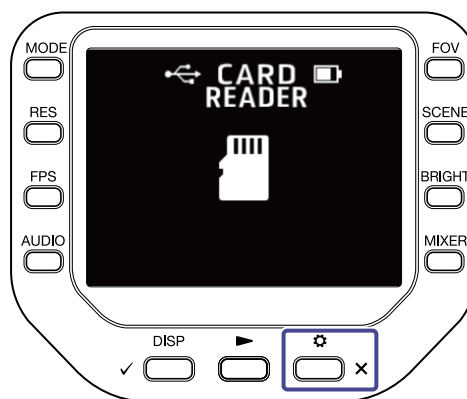

6. Press  on the SETTINGS Screen.

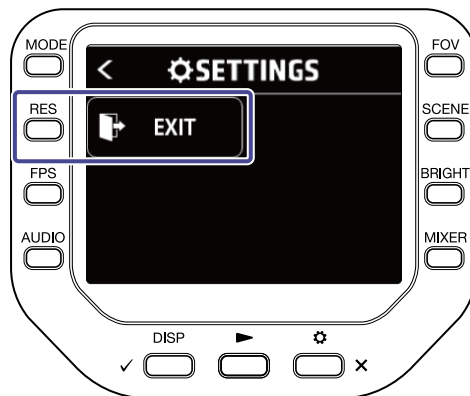

# Managing SD cards

## Checking SD card information

You can check the free space and size of microSD cards.

1. Press  on the Recording Screen to open the SETTINGS Screen.



2. Press  to open the SD CARD Screen.

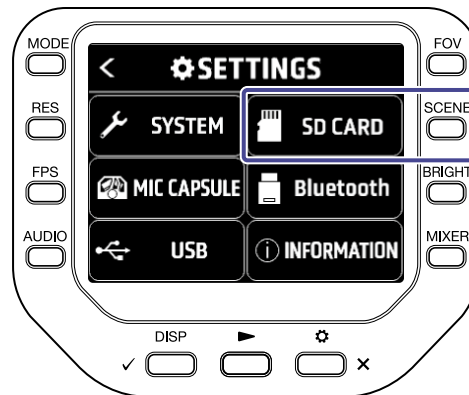

### 3. Press "SD Info".

The SD card information will be shown.

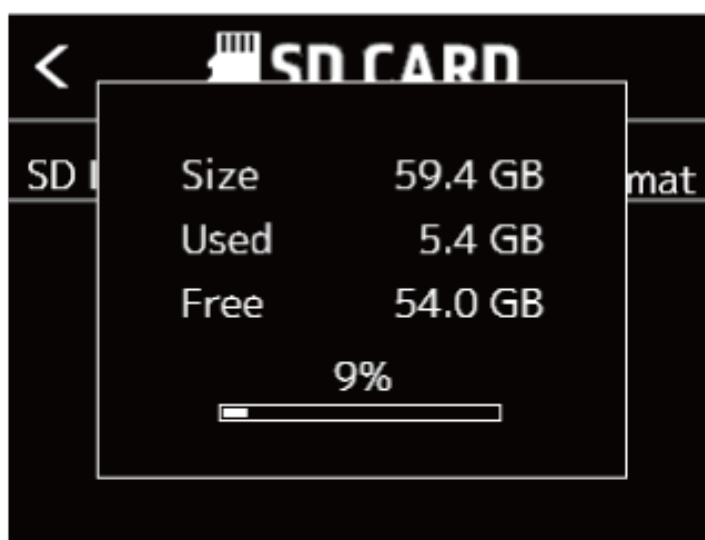
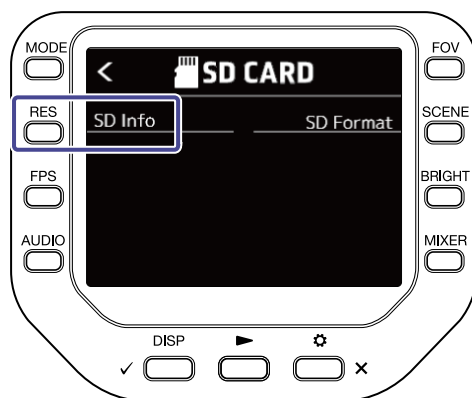

Press any button to turn off the display.

# Formatting SD cards

1. Press  on the Recording Screen to open the SETTINGS Screen.



2. Press  to open the SD CARD Screen.

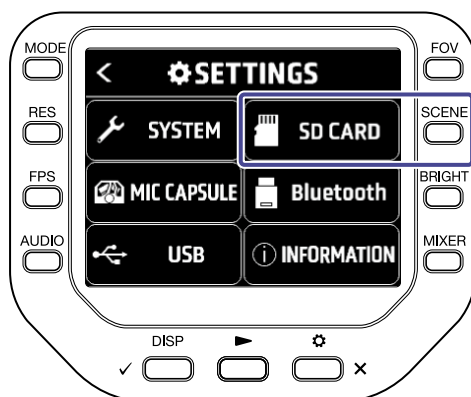

3. Press "SD Format" on the SD CARD Screen.

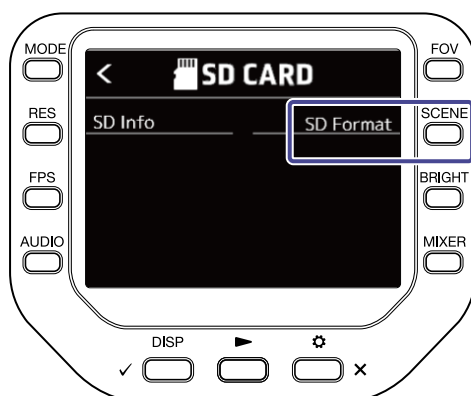

4. Press  to start SD card formatting.

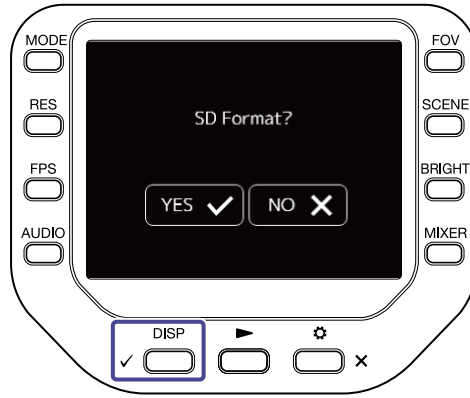

To cancel formatting, press  x.

# Operating from an iOS/iPadOS/Android device

## Connecting an iOS/iPadOS/Android device

When a dedicated wireless adapter (e.g. BTA-1) is connected, the Q8n-4K can be operated from an iOS/iPadOS/Android device using the dedicated Q8n Control app.

**NOTE:**

The Q8n Control app must be installed on the iOS/iPadOS/Android device in advance. The Q8n Control app can be downloaded from the App Store or Google Play.

For app setting and operation procedures, see the manual for the Q8n Control app.

1. Remove the REMOTE connector cover and connect a BTA-1 or other dedicated wireless adapter.

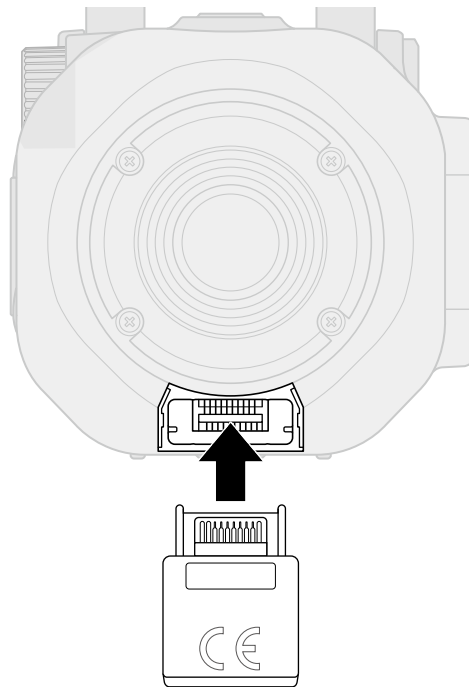

2. Press  on the Recording Screen.  
The SETTINGS Screen opens.



3. Press  on the SETTINGS Screen.

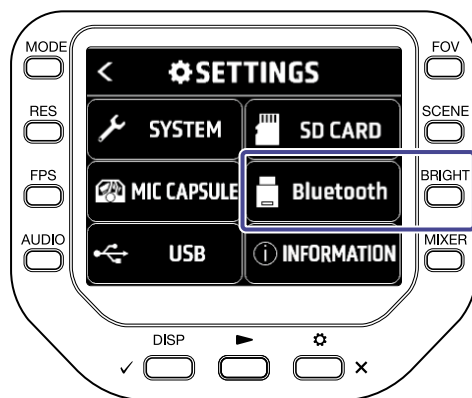

4. Press "Connect".

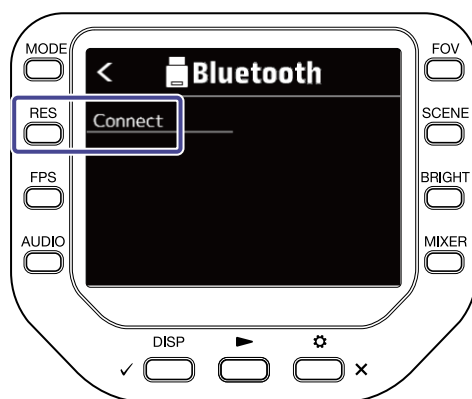

5. Launch the Q8n Control app on the iOS/iPadOS/Android device, and conduct connection procedures.



# Disconnecting from the iOS/iPadOS/Android device

1. Press  on the Recording Screen.



2. Press  on the SETTINGS Screen.

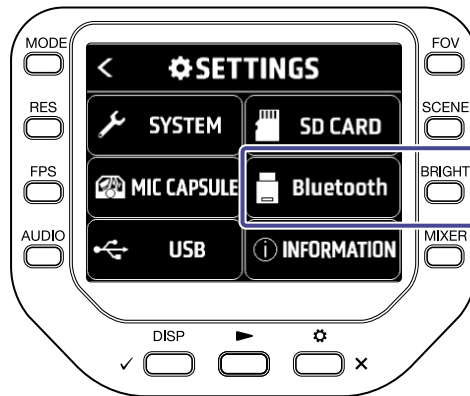

3. Press "Disconnect".

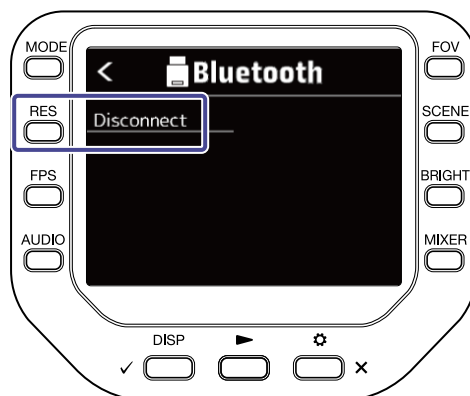

# Using connected to a TV / monitor by HDMI

Use an HDMI cable to connect with a TV / monitor to view the Q8n-4K video recordings on it.

You can play / stop the recorded video by using the remote control of the HDMI-CEC-compatible TV.

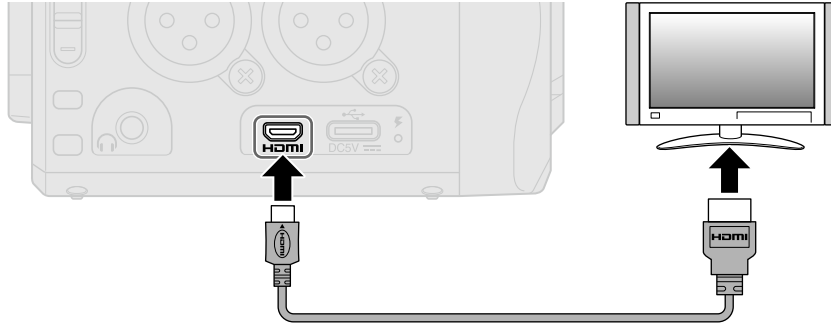

## Checking the Recording Screen on an HDMI-compatible TV / monitor

You can view Q8n-4K video recordings on a TV / monitor by using an HDMI cable.

If you connect an HDMI cable (commercially-available) to the Micro HDMI port, you can view Q8n-4K video recordings when the Recording Screen is open.



### 1 Available recording time

This shows the available recording time.

### 2 Remaining battery level

This shows the remaining battery level. When the remaining battery level is low, charge the battery or connect the AC adapter.

### 3 Color buttons

Use the TV remote control red button to change the screen display and use the yellow button to play the video.

## Playback on an HDMI-compatible TV / monitor

You can view Q8n-4K video recordings on a TV / monitor by using an HDMI cable.

1. Connect the Q8n-4K to a TV / monitor with an HDMI cable (commercially-available).

2. Press  to play back the video and audio.

The recorded file will be played back on the TV / monitor screen.

During TV / monitor output, the unit can be operated with its own controls or the TV remote control.



#### 1 File number

This shows the file number being played / total number of files .

#### 2 File name

This shows the name of the file being played back.

#### 3 Remaining battery level

This shows the remaining battery level. When the remaining battery level is low, charge the battery or connect the AC adapter.

#### 4 Color buttons

Use the TV remote control blue button to select the sound source, use the red button to change the screen display, and use the yellow button to open the Recording Screen.

#### 5 Up and down buttons

Select the file to be played.

**6 Left and right buttons**

Search backward and forward for the playback position.

**7 Enter button**

Start / pause playback.

**8 Playback position**

The current playback position, elapsed time, and video length are displayed.

**NOTE:**

- Some TVs / monitors do not support some audio formats, so correct playback might not always be possible.
- Since there is a risk of feedback when the Recording Screen is open, mute the audio output of the TV / monitor.
- Only video files recorded with the Q8n-4K can be played back.
- During HDMI connection, the beep is not output.

# Setting the unit

You can make various settings for the Q8n-4K on the SYSTEM Screen.

- 1. Press  on the Recording Screen.  
The SETTINGS Screen opens.



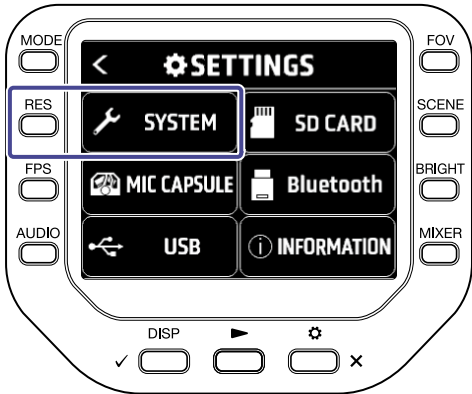

- 2. Press  on the SETTINGS Screen.  
The SYSTEM Screen opens.

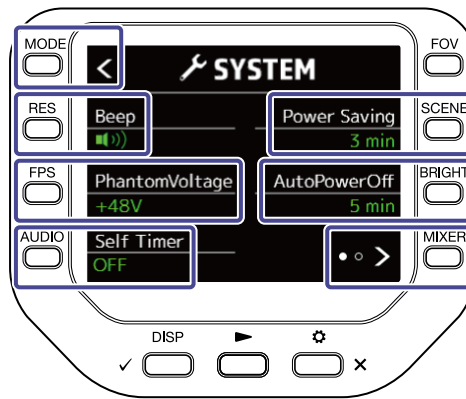





You can make the following settings on the SYSTEM Screen.

Button	Explanation
	Return to the SETTINGS Screen.
"Beep"	Adjust the volume of the operation sound (beep).
"PhantomVoltage"	Change the phantom power voltage.
"Self Timer"	Set the self timer.
"Power Saving"	Set the display backlight time.
"AutoPowerOff"	Set the automatic power off function.
	Proceed to the next SYSTEM Screen.

Press  on the SYSTEM Screen to proceed to the next SYSTEM Screen.

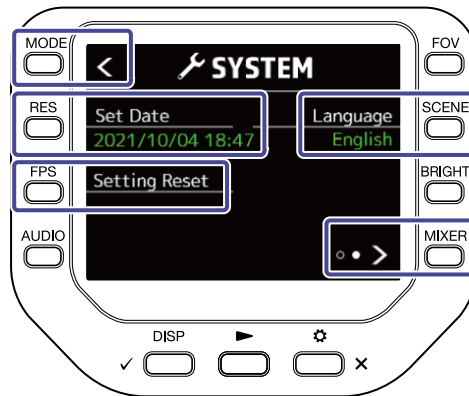
You can make the following settings on the next SYSTEM Screen.



Button	Explanation
	Return to the SETTINGS Screen.
"Set Date"	Change the date and time.
"Setting Reset"	Reset the settings.
"Language"	Change the language.
	Return to the previous SYSTEM Screen.

# Setting the volume of the operation sound (Beep)

Set the volume of the Q8n-4K operation sound.

1. Press  on the Recording Screen.

The SETTINGS Screen opens.



2. Press  SYSTEM on the SETTINGS Screen.

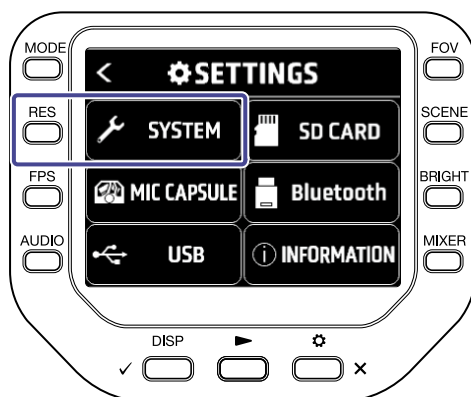

The SYSTEM Screen opens.

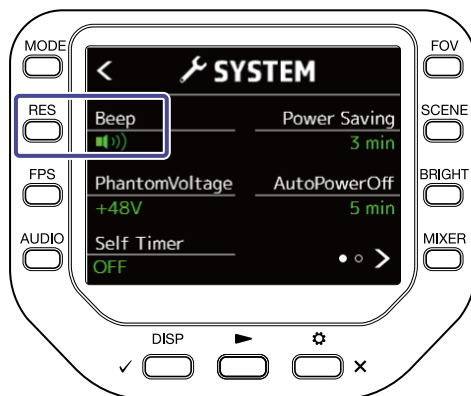

3. Press "Beep" to set the volume.





Setting	Explanation
	No operation sound is output.
	A low-volume operation sound is output.
	A high-volume operation sound is output.

4. Press  x twice.

This reopens the Recording Screen.

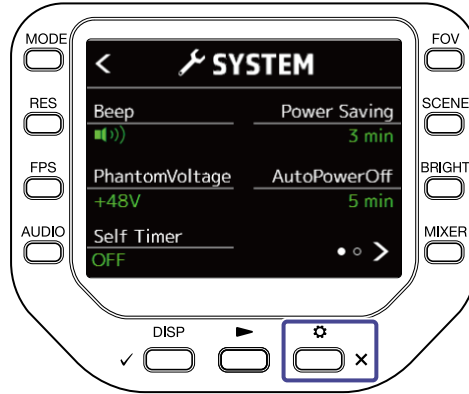

## Enabling Power Saving

### Setting the display backlight time

Power can be saved by shortening the amount of time that the backlight stays lit.

1. Press  x on the Recording Screen.

The SETTINGS Screen opens.



2. Press  on the SETTINGS Screen.

The SYSTEM Screen opens.

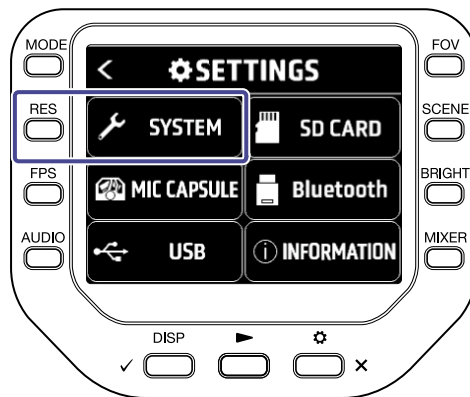

3. Press "Power Saving", and set the time until the backlight dims.

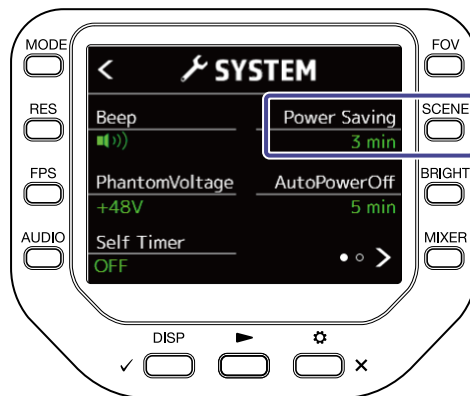

Setting	Explanation
OFF	The backlight always stays bright.
1 min	The backlight dims if no operation occurs for 1 minute.
3 min	The backlight dims if no operation occurs for 3 minutes.
5 min	The backlight dims if no operation occurs for 5 minutes.

4. Press  x twice.

This reopens the Recording Screen.

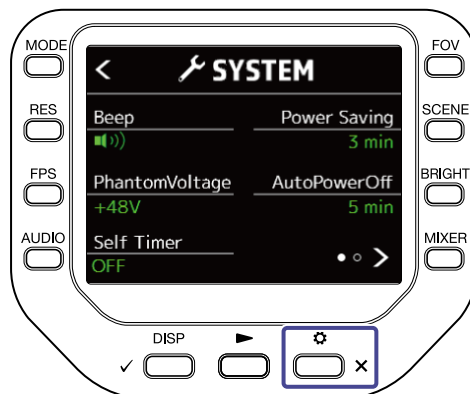

# Setting the Auto Power Off function

Set the unit to turn off automatically if not used at all for a set amount of time when running on battery power.

**NOTE:**

This function is disabled during recording and playback as well as when it is powered through its USB port.

1. Press  on the Recording Screen  
The SETTINGS Screen opens.



2. Press  on the SETTINGS Screen.  
The SYSTEM Screen opens.

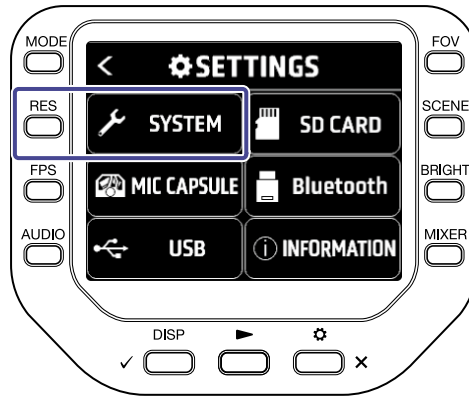

3. Press "AutoPowerOff", and set the time until the power turns off.



Settings	Explanation
OFF	The Auto Power Off function is disabled.
1 min	The power will turn off automatically 1 minute after the last operation.
3 min	The power will turn off automatically 3 minutes after the last operation.
5 min	The power will turn off automatically 5 minutes after the last operation.

4. Press  x twice.

This reopens the Recording Screen.

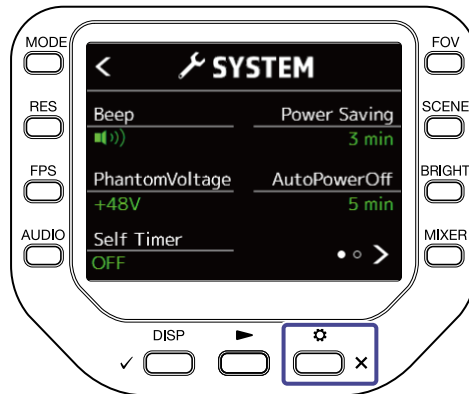

# Setting the date and time

If the date and time are set, you can add the recording date and time to files.

1. Press  on the Recording Screen.

The SETTINGS Screen opens.



2. Press  SYSTEM on the SETTINGS Screen.

The SYSTEM Screen opens.

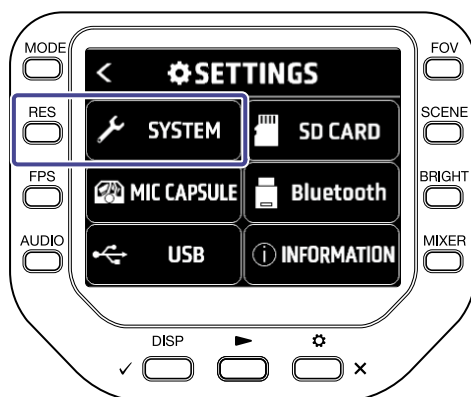

3. Press .

The next SYSTEM Screen opens.

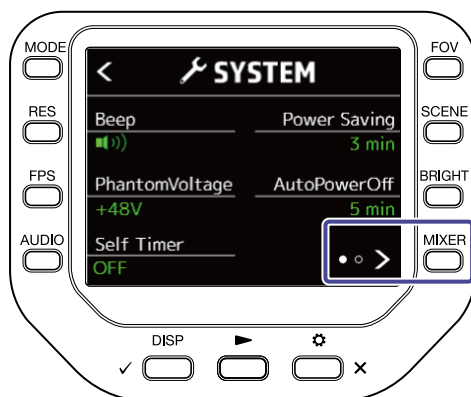

4. Press "Set Date"  
The SET DATE Screen opens.

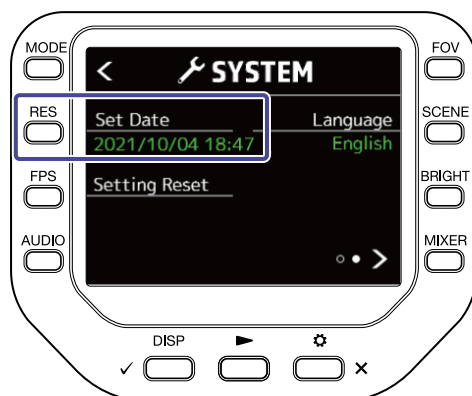

5. Press the corresponding  to change the date and time.

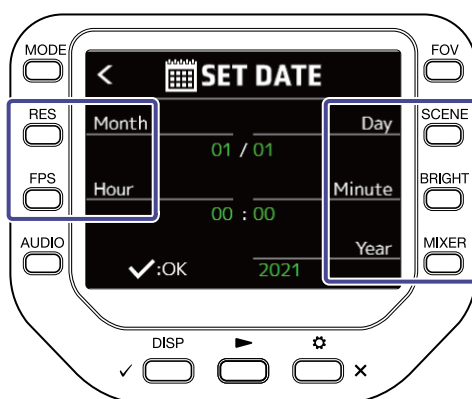

6. Press .  
This reopens the SYSTEM Screen.

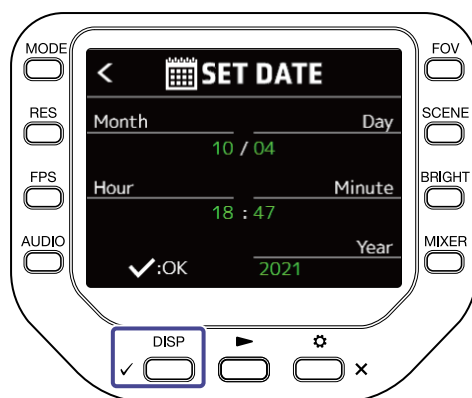

# Setting the language shown

Set the language shown on the display.

1. Press  on the Recording Screen.  
The SETTINGS Screen opens.



2. Press  SYSTEM on the SETTINGS Screen.  
The SYSTEM Screen opens.

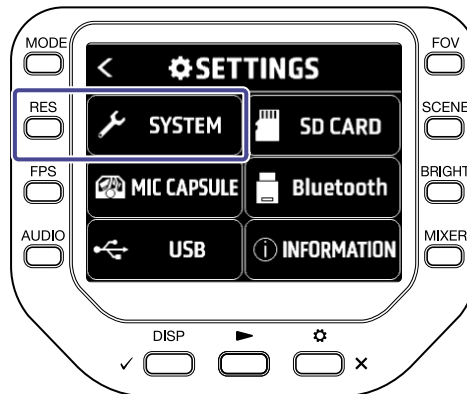

3. Press .  
The next SYSTEM Screen opens.

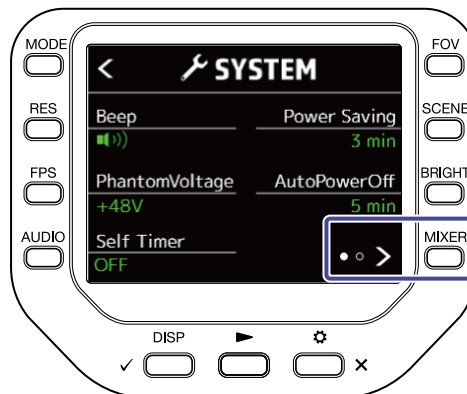

4. Press "Language", and set the language.

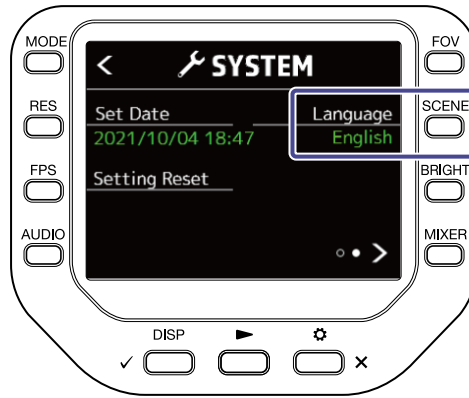

5. Press  x twice.

This reopens the Recording Screen.

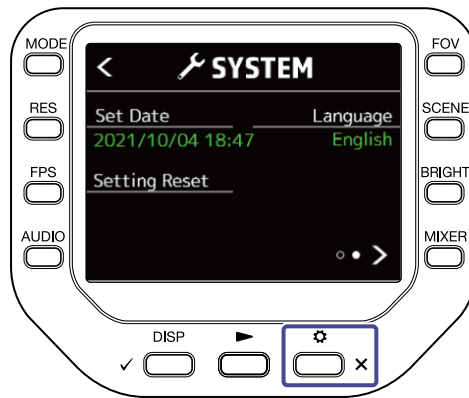



# Restoring default settings

You can restore all Q8n-4K settings to their factory defaults.

1. Press  on the Recording Screen.  
The SETTINGS Screen opens.



2. Press  on the SETTINGS Screen.  
The SYSTEM Screen opens.

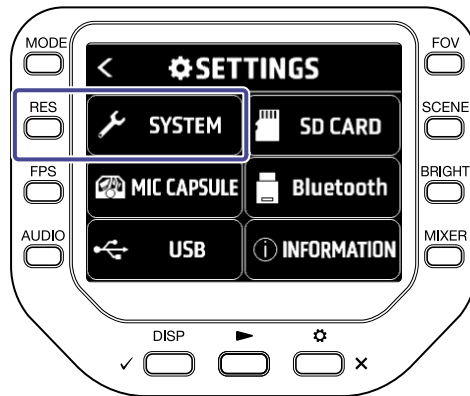

3. Press .  
The next SYSTEM Screen opens.

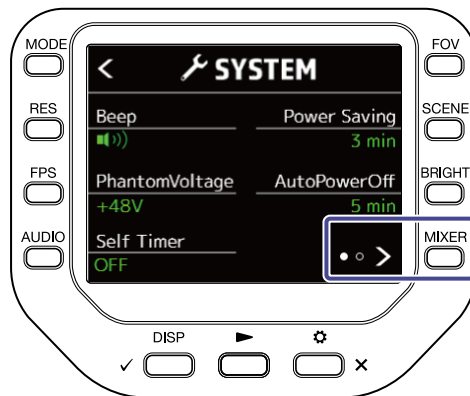

**4.** Press "Setting Reset".

The reset confirmation screen opens.

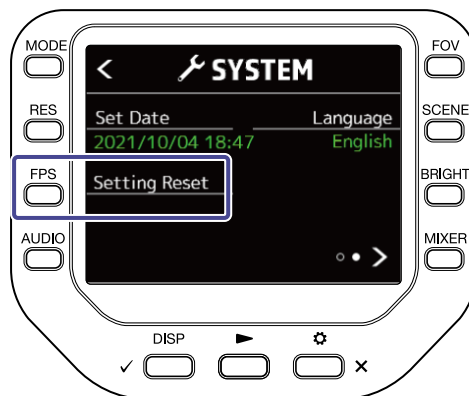

**5.** Press .

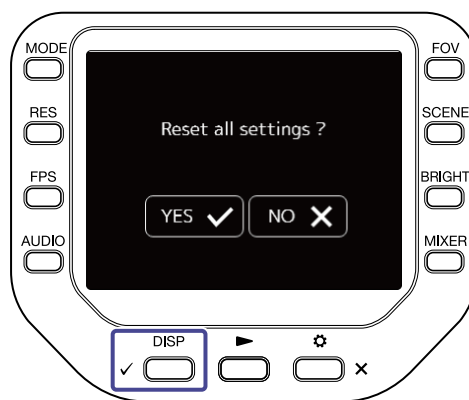

This starts resetting the Q8n-4K.

After resetting completes, the power will automatically turn off.

To cancel resetting, press  x.

# Managing the firmware

## Checking the firmware versions

The firmware versions used by the Q8n-4K can be checked.

1. Press  on the Recording Screen.  
The SETTINGS Screen opens.



2. Press  on the SETTINGS Screen.

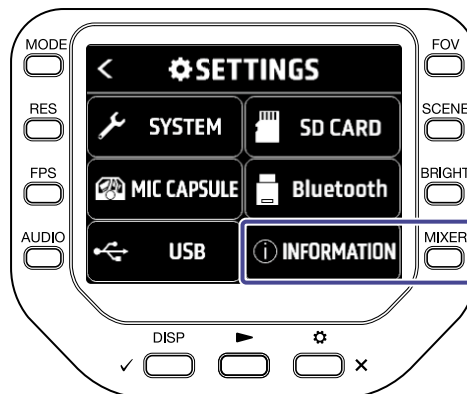

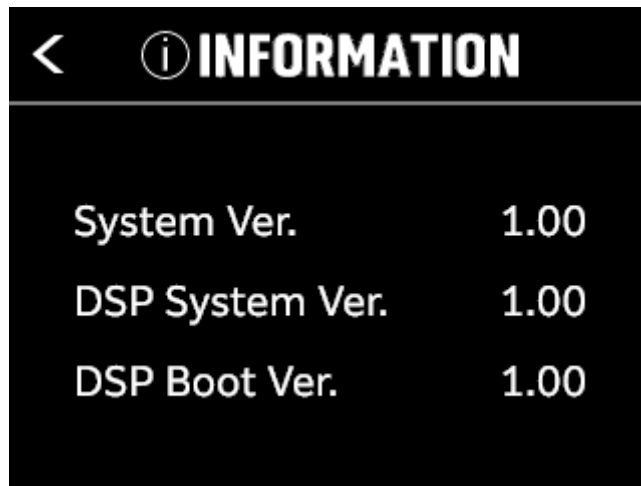

This shows the Q8n-4K firmware versions.

3. Press  x twice

This reopens the Recording Screen.

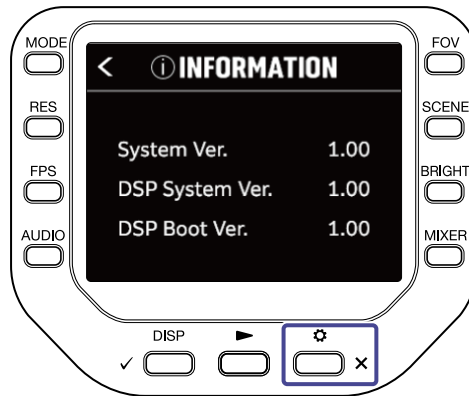

## Updating the firmware

The Q8n-4K firmware can be updated to the latest versions.

The latest firmware update file can be downloaded from the ZOOM website ([zoomcorp.com](https://zoomcorp.com)).

Refer to Q8n-4K Firmware Update Guide on the Q8n-4K download page.

# Mic capsule information

## Checking mic capsule information

1. Press  on the Recording Screen.  
The SETTINGS Screen opens.



2. Press  on the SETTINGS Screen.  
The MIC CAPSULE Screen opens.

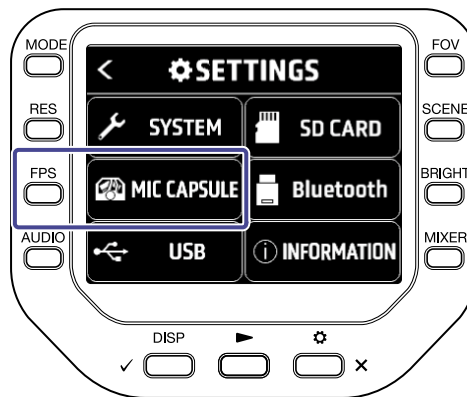

### 3. Press "Information".

Information about the mic capsule is shown.

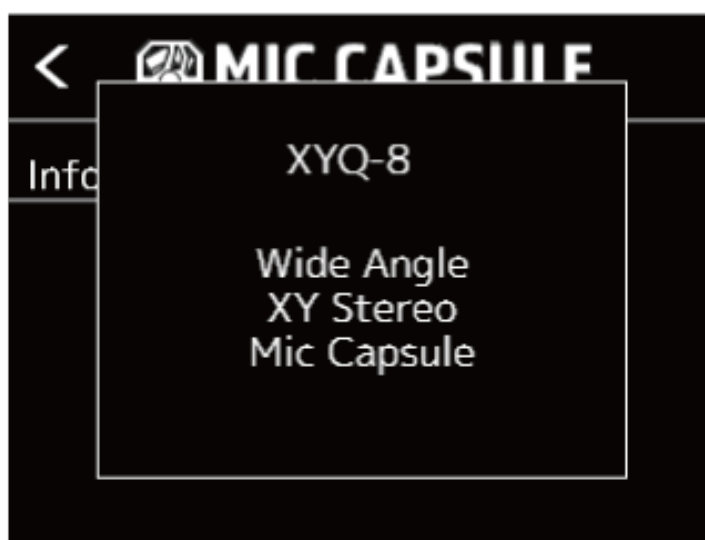
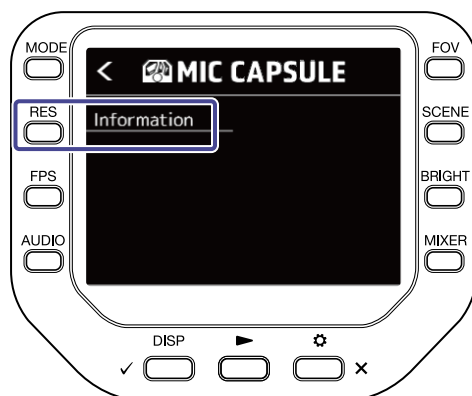

Press any button to close the information.



## Using optional mic capsules

The Q8n-4K allows mic capsules to be switched for different circumstances.

When using optional mic capsules, there is basically no difference in the display and operation from when using the included mic capsule. However, you can change settings specific to each mic capsule.

The table below shows which mic capsules are compatible with the Q8n-4K.

Mic capsule		Description	Compatible with the Q8n-4K
	XAH-8	XY-AB stereo mic	✓
	VRH-8	Ambisonic VR mic	✓
	EXH-8	4-channel XLR input	Not compatible
	XYH-6	90/120° angle-switchable XY stereo mic	✓
	XYH-5	XY stereo mic with shock mount	✓
	MSH-6	Mid-side stereo mic	✓

Mic capsule		Description	Compatible with the Q8n-4K
	SSH-6	Mid-side stereo shotgun mic	✓
	SGH-6	Shotgun mic	✓
	EXH-6	2-channel XLR/TRS input	✓

## Using the XAH-8



The XAH-8 is a stereo mic capsule that can use two stereo formats ("XY" and "AB"). There is basically no difference in the display and operation from when using the included mic capsule.



## Using the VRH-8



The VRH-8 is an Ambisonic mic capsule that can capture 360° audio recordings with four mics to produce vertical spread and front-back depth. It supports three audio recording formats: AmbiX, FuMa and Ambisonics A.

### Functions when using a VRH-8 with a Q8n-4K:

- Available audio recording formats
  - 48 kHz/24-bit
  - 48 kHz/16-bit
  - 44.1 kHz/24-bit
  - 44.1 kHz/16-bit
- Available recording modes
  - MOV+WAV
  - WAV(MULTI)
- Audio channels that can be played back
  - MIXED: audio of stereo mixdown selected during recording
  - Ambix/FuMa/Ambisonics A: W channel audio (Omni)
- The VRH-8's mic position is fixed at upright.
- INPUT 1 and INPUT 2 jacks are disabled.

# Changing audio recording formats

You can set the audio recording format to AmbiX, FuMa or Ambisonics A.

1. Press  on the Recording Screen.  
The SETTINGS Screen opens.

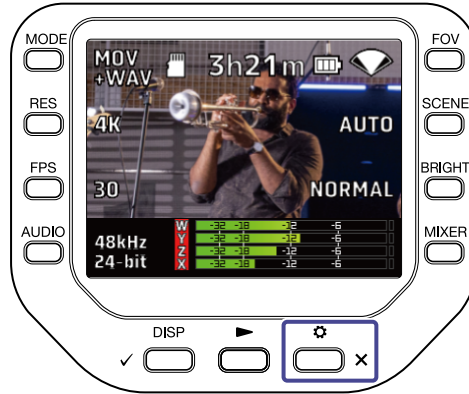

2. Press  on the SETTINGS Screen.  
The MIC CAPSULE Screen opens.

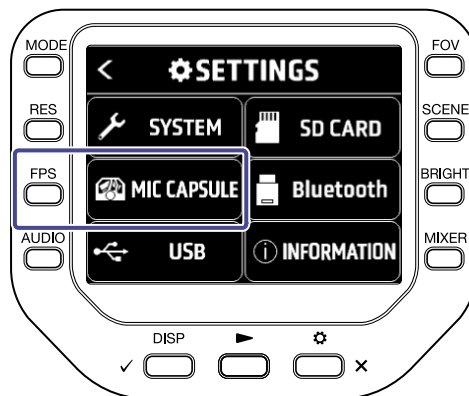

3. Press "Format".  
The audio recording format changes.

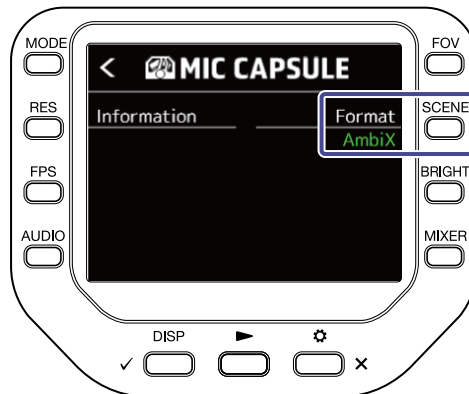



## Changing stereo mixdown modes

You can select a mixdown mode for stereo audio files when using the VRH-8.

Mixdown mode	Explanation
360° OMNI	This outputs a mono mix of sound from all directions.
90° STEREO	This outputs stereo sound from the front 90°.

1. Press  on the Recording/Recording Standby Screen, Webcam Screen, or USB Mic Screen.  
The Mixer Screen opens.



2. Press  or .
- Mixdown mode changes.

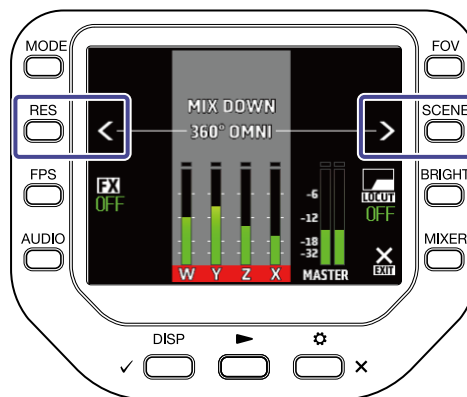

# Using the XYH-6



The XYH-6 is an XY stereo mic capsule that allows you to set the angle between mics to 90° or 120°. The XYH-6 also has a MIC/LINE IN input jack (that supports plug-in power) to input sound from external devices.

## Using plug-in power

Make the following setting when a mic that supports plug-in power is connected to the MIC/LINE IN input jack of the mic capsule.

1. Press  on the Recording Screen.  
The SETTINGS Screen opens.



2. Press  on the SETTINGS Screen.  
The MIC CAPSULE Screen opens.

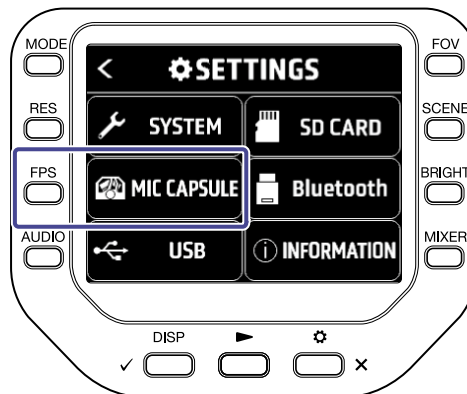

### 3. Press "Plug-in Power".

Plug-in Power is turned on and the mic is supplied with power.

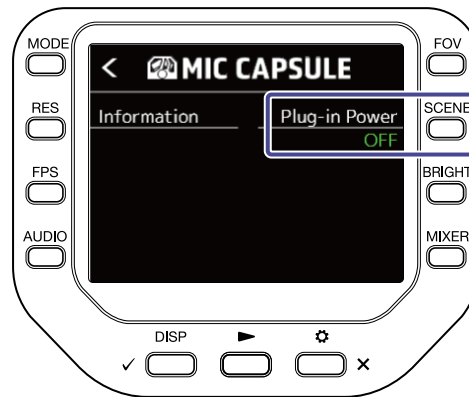

## Using the XYH-5



The XYH-5 is an XY stereo mic capsule equipped with a shockmount mechanism. The XYH-5 also has a MIC/LINE IN input jack (that supports plug-in power) to input sound from external devices.

## Using plug-in power

Make the following setting when a mic that supports plug-in power is connected to the MIC/LINE IN input jack of the mic capsule.

### 1. Press on the Recording Screen.

The SETTINGS Screen opens.



2. Press  on the SETTINGS Screen.

The MIC CAPSULE Screen opens.

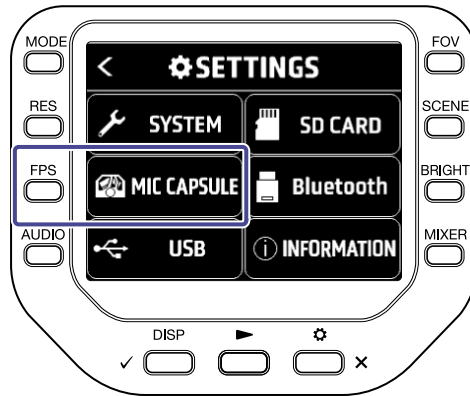

3. Press "Plug-in Power".

Plug-in Power is turned on and the mic is supplied with power.

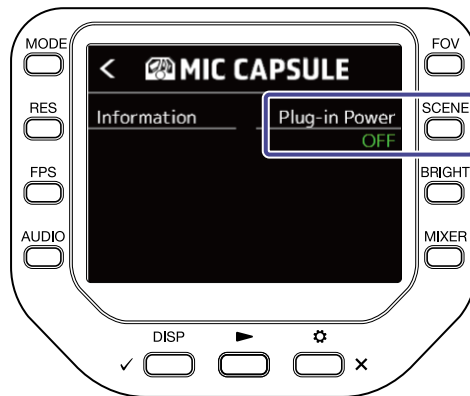

# Using the MSH-6



The MSH-6 is a mid-side stereo mic capsule with a forward-facing, unidirectional mic (mid) and a side-facing, bi-directional mic (side). You can change the stereo width freely by adjusting the MS side level.

## Adjusting the side level

You can set the side level (stereo width) from 0° (mono) to 150° in 30° increments when using the MSH-6.

1. Press  on the Recording Screen.  
The SETTINGS Screen opens.



2. Press  on the SETTINGS Screen.  
The MIC CAPSULE Screen opens.

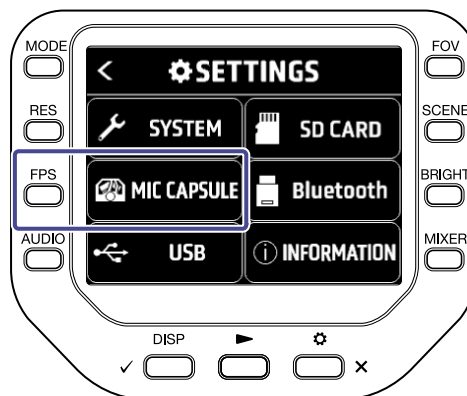

3. Press "MS Side Level".  
The MS side level changes.

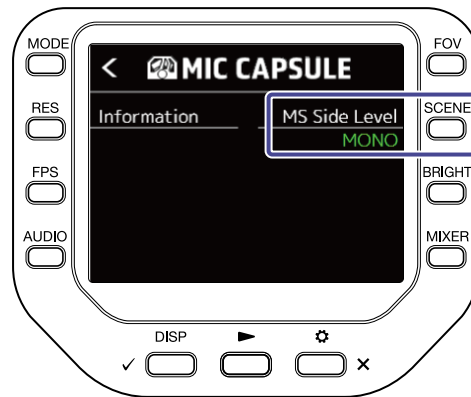



## Using the SSH-6



The SSH-6 is a mid-side stereo mic capsule that includes a super-directional shotgun mic (mid) for picking up sound from the center and a bidirectional mic (side) for picking up sounds from the left and right. You can change the stereo width freely by adjusting the side level.

## Adjusting the side level

You can set the side level (stereo width) from 0° (mono) to 150° in 30° increments when using the SSH-6.

1. Press   on the Recording Screen.  
The SETTINGS Screen opens.





2. Press  on the SETTINGS Screen.

The MIC CAPSULE Screen opens.

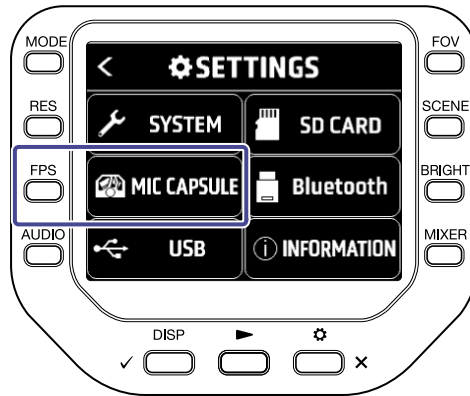

3. Press "MS Side Level".

The MS side level changes.

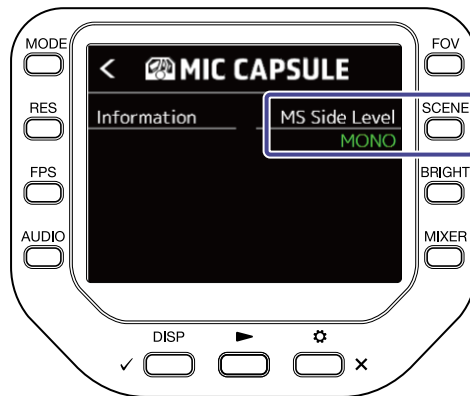

## Using the SGH-6



The SGH-6 is a mono shotgun mic capsule with a super-directional mic that suppress ambient noise and focuses on the desired sound. Mono audio is input to L/R MIC channels. There is basically no difference in the display and operation from when using the included mic capsule.

# Using the EXH-6



The EXH-6 is an XLR/TRS combo capsule that provides additional external inputs for two channels. Signals from dynamic mics, line-level instruments, mixers and portable music players, for example, can be input through it.

## Mixing stereo signals to mono

When using the EXH-6, you can mix the inputs of its two channels to mono.

When Mono Mix is ON, a mono mix of the audio from both EXH-6 external inputs will be sent to both MIC L/R channels.

1. Press  on the Recording Screen.  
The SETTINGS Screen opens.



2. Press  on the SETTINGS Screen.  
The MIC CAPSULE Screen opens.

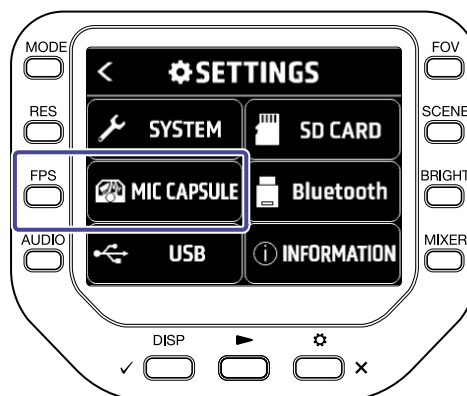

3. Press "Mono Mix".  
Mono Mix turns on.

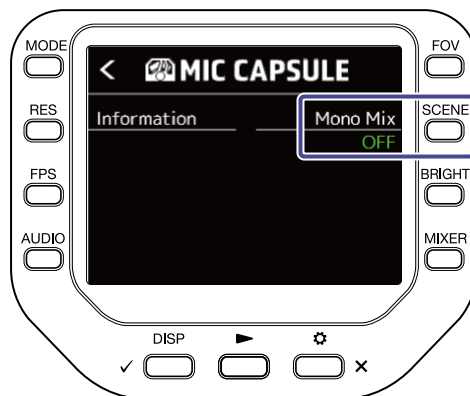

# Troubleshooting

---

## There is no sound or output is very quiet

- Check the connections with connected output devices and their volume settings.
- Confirm that the Q8n-4K volume is not set low.

## Recorded sound cannot be heard or is very quiet

- If you are using a mic capsule, confirm that the input level settings are suitable and that it is oriented correctly. (→ [Adjusting audio \(setting input/output\)](#))
- Check the input level settings. (→ [Adjusting audio \(setting input/output\)](#))
- If another device is connected to an input jack, raise the output level of that device.
- If a condenser mic is connected to an input jack, check the phantom power and phantom power voltage settings. (→ [Using phantom power](#))
- If using an input jack, confirm that PAD is set appropriately. (→ [Using the PAD function](#))

## Recording audio/video is not possible

- Confirm that the button indicators for the channels to be recorded are lit red.
- Confirm that the microSD card has open space. (→ [Checking SD card information](#))
- Confirm that a microSD card is loaded properly in the card slot. (→ [Inserting microSD cards](#))

## The recorder becomes warm

- The unit and the microSD card might become warm but this is not a malfunction.
- If the internal temperature becomes too high when using the Q8n-4K, a warning will sound and the power will turn off automatically. Wait for the temperature to decrease before using it again.

## A “Low Speed Card!” warning appears frequently / Stopping recording takes a very long time

- microSD cards can become worn out. Speed can decrease after repeated writing and erasing.
- Formatting the card with the Q8n-4K might improve this. (→ [Formatting SD cards](#))
- If formatting a microSD card does not improve this, we recommend replacing the card. Please check the list of cards that have been confirmed to work on the ZOOM website ([zoomcorp.com](https://zoomcorp.com))

## Charging is slow or not possible

- The battery will not charge while the power is on. (→ [Recharging the battery](#))

## Computer does not recognize it even though it is connected to a USB port

- Confirm that the USB cable being used supports data transfer.

## A channel keeps blinking on the Recording Screen

- Lower the input volume, set the PAD switch to -20 dB, or lower the output level of the external device.

# Specifications

Image sensor		1/2.3" 16 M-pixel CMOS sensor
Lens		F 2.8, 150° FOV
Video format		MPEG-4 AVC/H.264 (MOV)
Video resolutions		4K/30, 25, 24 fps 1080/60, 50, 30, 25, 24 fps 720/60, 50, 30, 25, 24 fps
Audio formats		WAV: 96 kHz/24-bit, 16-bit 48 kHz/24-bit, 16-bit 44.1 kHz/24-bit, 16-bit
Audio functions		LoCut: Off / 80 Hz / 120 Hz / 160 Hz / 200 Hz / 240 Hz Fx: Off / Limiter / Compressor / Leveler / DeEsser / NoiseGate Level: $-\infty$ dB – +10 dB Pan: L100 – Center – R100 Delay: 0 ms, 10 ms ... 300 ms (only during web camera use) Direct Monitor: On/Off (only during web camera and USB mic use)
Image functions	FOV	5 steps
	SCENE	AUTO / INDOOR / OUTDOOR / NIGHT / CONCERT LIGHT
	Self timer	OFF / 3 sec / 5 sec / 10 sec
	BRIGHT	LOW / NORMAL / HIGH
Display		2.0" full-color LCD 320 × 240
Audio inputs	MIC	XY Mic: XYQ-8 (120° XY stereo mic) Maximum sound pressure: 120 dB SPL Input gain: $-\infty$ dB – 43 dB
	INPUT 1/2	Input connector: XLR Input gain (PAD OFF): $-\infty$ dB – 55 dB Input impedance : 1.8 k $\Omega$ or more Maximum permissible input level: +26 dBu (PAD ON) Phantom power: +12 V / +24 V / +48 V Equivalent input noise: -120 dBu or less
Output connectors		Combined line/headphone stereo mini jack HDMI micro Type D
Built-in speaker		300 mW 8 $\Omega$ mono speaker
Recording media		microSD / microSDHC / microSDXC (512 GB maximum)

USB	<p>USB Type-C          &lt; WEBCAM &gt;          Class: UVC 1.0 + UAC 1.0          Formats: 720 p, 1080 p WVGA video          48 kHz/16-bit audio stereo output          &lt; CARD READER &gt;          Class: USB Mass Storage          &lt; USB MIC &gt;          Class: UAC 1.0, Format: 44.1 kHz/16-bit          2-input/2-output          Note: card reader and USB mic functions support iOS/iPadOS devices          Note: supports USB bus power operation          Note: Use USB cable that supports data transfer.</p>
REMOTE	ZOOM BTA-1 or other dedicated wireless adapter
Power	<p>Lithium-ion battery: DC 4.2 V maximum voltage, DC 3.7 V nominal voltage, 1600 mAh capacity          AC adapter (ZOOM AD-17): DC 5 V/1 A</p>
Recharging times	<p>By USB 2.0 port: about 4 hours and 30 minutes          By USB 3.0 port: about 3 hours          Using ZOOM AD-17: about 3 hours</p>
Battery operation time	<p>4K/30: 1 hour and 20 minutes          1080/30: 2 hours and 30 minutes          Note: Times when MOV mode, 48 kHz/24-bit, XYQ-8 connected, no XLR input, Power Saving enabled</p>
External dimensions	<p>Main unit (mic arm lowered): 159 mm (D) × 68 mm (W) × 65 mm (H)          Main unit (mic arm raised) : 134 mm (D) × 68 mm (W) × 135 mm (H)          Mic: 45 mm (D) × 66 mm (W) × 51 mm (H)</p>
Weight	367 g (including battery)



ZOOM CORPORATION

4-4-3 Kanda-surugadai, Chiyoda-ku, Tokyo 101-0062 Japan

[zoomcorp.com](https://zoomcorp.com)