

L-20R

LiveTrak

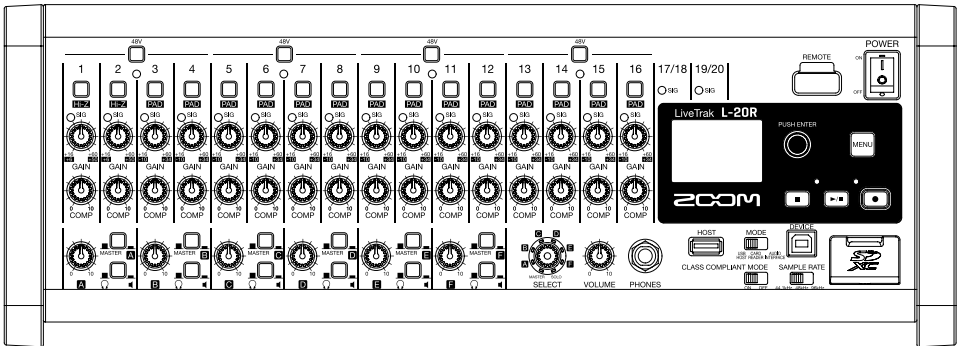

Quick Guide

You must read the Usage and Safety Precautions before use.



The Operation Manual can be downloaded from the ZOOM website (www.zoom.jp/docs/l-20r). This page has files in PDF and ePub formats.
 The PDF file format is suitable for printing on paper and reading on a computer.
 The ePub format can be read with electronic document readers and is designed for reading on smartphones and tablets.

Product overview

The ZOOM LiveTrak **L-20R** is a digital mixer that can be controlled remotely from a distance using an iPad. Install the dedicated L-20 Control app on your iPad.

Copyrights

- © Windows® is a trademark or registered trademark of Microsoft® Corporation.
- © Macintosh, macOS and iPad are trademarks or registered trademarks of Apple Inc.
- © iOS is a trademark or registered trademark of Cisco Systems, Inc. and used under license.
- © App Store is a service mark of Apple Inc.
- © The SD, SDHC and SDXC logos are trademarks.
- © The Bluetooth® word mark and logo are registered trademarks of Bluetooth SIG, Inc. and these marks are used under license by Zoom Corporation. Other trademarks and trade names are the property of their respective companies.
- © Other product names, registered trademarks and company names in this document are the property of their respective companies.

Note: All trademarks and registered trademarks in this document are for identification purposes only and are not intended to infringe on the copyrights of their respective owners.

Recording from copyrighted sources, including CDs, records, tapes, live performances, video works and broadcasts, without permission of the copyright holder for any purpose other than personal use is prohibited by law. Zoom Corporation will not assume any responsibility related to infringements of copyrights.

Equipment connection example

This example shows live PA system connections.

Front

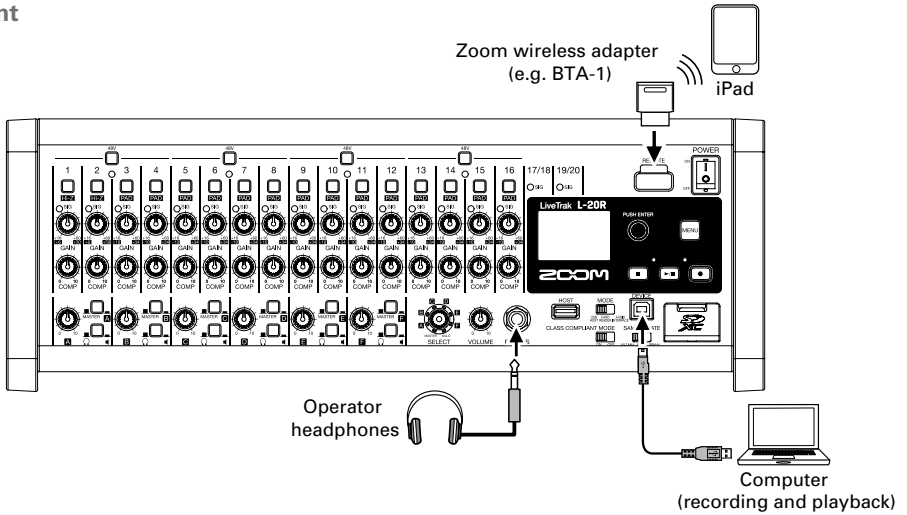

Back

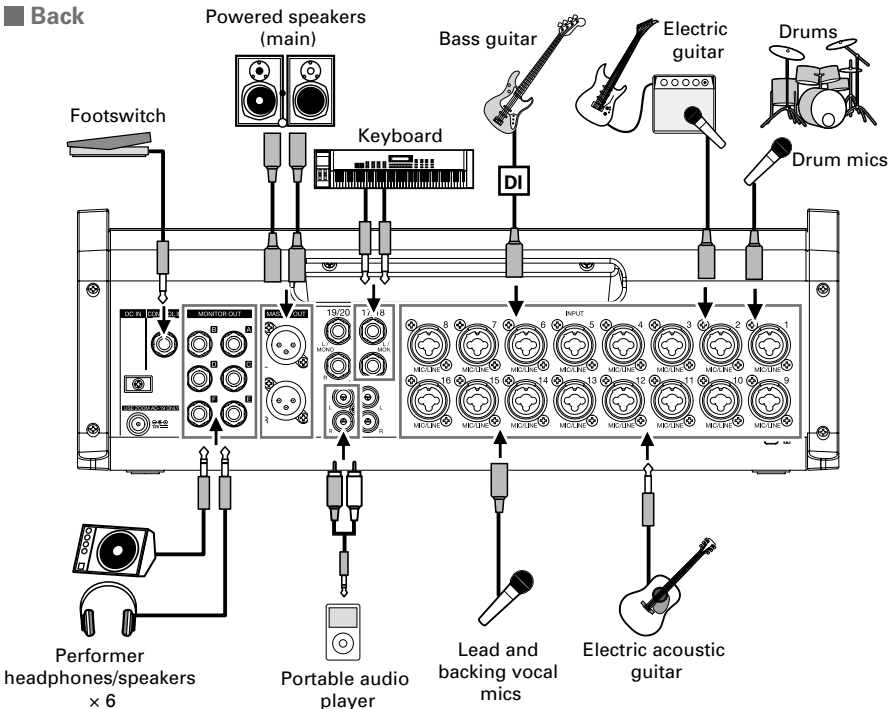

Names of parts

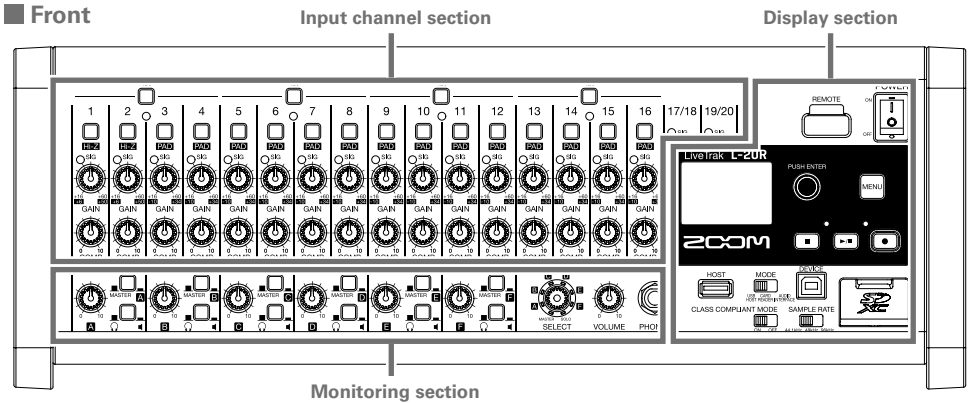

Input channel section

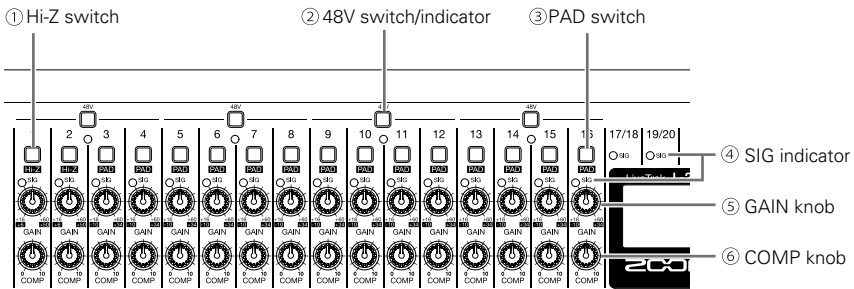

① Hi-Z switch

Use to switch the input impedance of MIC/LINE input jack 1 (or 2).

② 48V switch/indicator

This turns 48 V phantom power on or off.

③ PAD switch

This attenuates (reduces) the input signal of the equipment connected to MIC/LINE input jacks 3–16 by 26 dB.

④ SIG indicator

This shows the signal level after adjustment by the GAIN knob.

The indicator color changes according to the signal level. Adjust so that it does not light red.

Lit red: Input signal level is close (–3 dBFS or higher) to the clipping level (0 dBFS)

Lit green: Input signal level is between –48 dBFS and –3 dBFS compared to the clipping level (0 dBFS)

⑤ GAIN knob

Use to adjust the input gain of the mic preamp.

⑥ COMP knob

Use to adjust the amount of compression.

Monitoring section

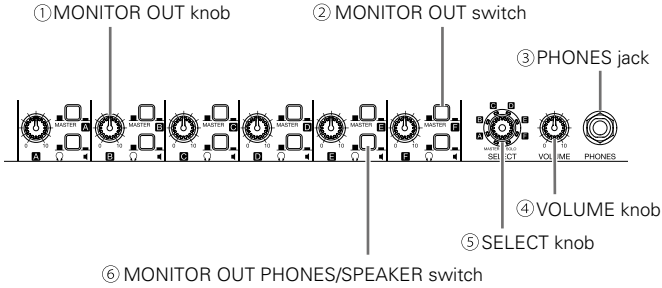



① MONITOR OUT knob

Use to adjust the volume of the signal output from the MONITOR OUT jacks.

② MONITOR OUT switch

This switches the signal output from the MONITOR OUT jacks.

MASTER (): The signal after adjustment by the master fader will be output.

A-F (): The signal set by the fader mode is output.

③ PHONES jack

Connect headphones here.

④ VOLUME knob

Use this to adjust the volume of the PHONES jack.

⑤ SELECT knob

Use this to select the signal output from the PHONES jack.

The options are MASTER, SOLO and MONITOR OUT A-F.



MASTER: The signals after adjustment by the master fader will be output.



A-F: The signal set by the fader mode is output.

SOLO: The signals of soloed channels are output.

⑥ MONITOR OUT PHONES/SPEAKER switch

Use this to select the type of equipment connected to the MONITOR OUT jack.

 (): Select this when headphones are connected. The signal output from the MONITOR OUT jack will be stereo.

 (): Select this when a speaker is connected. The signal output from the MONITOR OUT jack will be balanced mono.

Display section

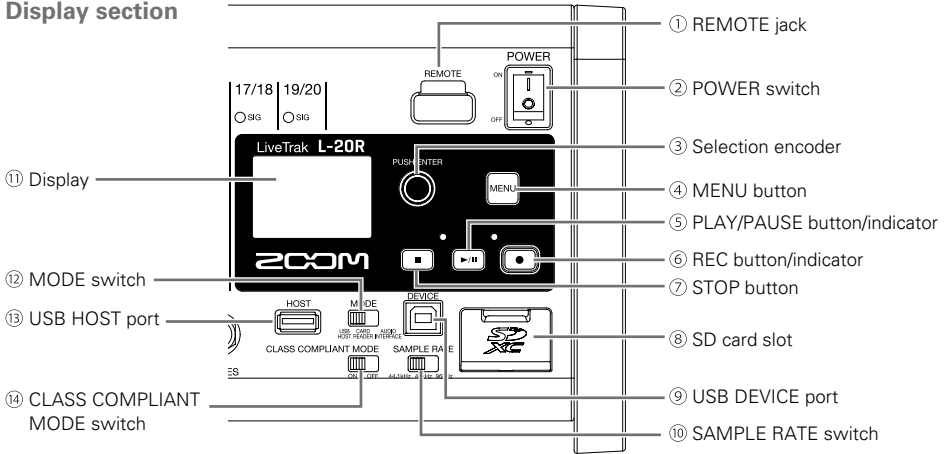

① REMOTE jack

A Zoom wireless adapter (e.g. BTA-1) can be connected here.

② POWER switch

This turns the unit on and off.

Switch to I to turn the power on. Switch to O to turn the power off.

When the POWER switch setting is changed to OFF, the current mixer settings are automatically saved in the unit and in the settings file in the project folder on the SD card.

③ Selection encoder

Use this to change menus and values and to move between items.

④ MENU button

This opens the menu.

⑤ PLAY/PAUSE button/indicator

This starts and pauses recorder playback, and the indicator shows the status.

⑥ REC button/indicator

This puts the recorder into standby, and the indicator shows the recording status.

⑦ STOP button

This stops the recorder.

⑧ SD card slot

This slot is for SD cards.

⑨ USB DEVICE port

This USB 2.0 port is for connecting with a computer.

⑩ SAMPLE RATE switch

Set the sampling rate used by the unit.

This cannot be changed after starting up.

⑪ Display

This shows the recorder status and menu screen.

12 MODE switch

Set whether to use as a USB HOST, card reader or audio interface. This cannot be changed after starting up.

13 USB HOST port

This USB 2.0 HOST port is for connecting USB flash drives.

14 CLASS COMPLIANT MODE switch

Use this to turn Class Compliant Mode on/off. This cannot be changed after starting up.

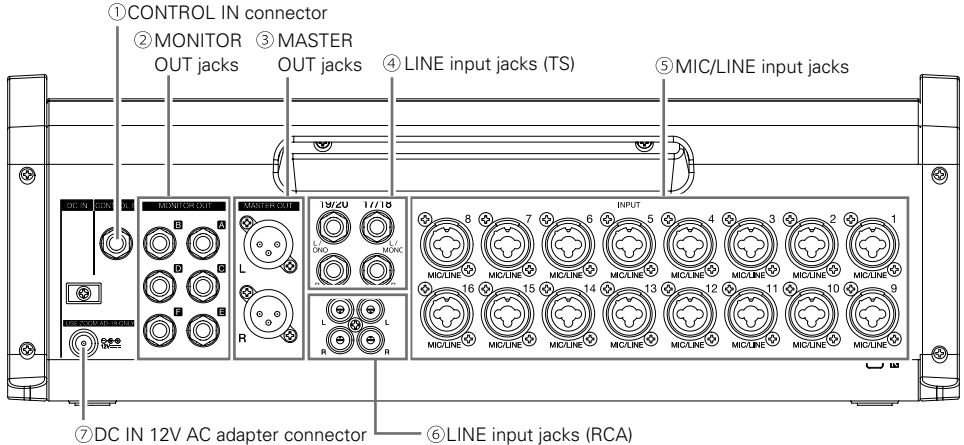
Back

① CONTROL IN connector

A footswitch (ZOOM FS01) can be connected here.

The footswitch can be assigned to one function: starting/stopping recorder playback, manually punching in/out or muting/unmuting the built-in effect.

② MONITOR OUT jacks

These jacks output signals after volume adjustment by the MONITOR OUT knobs.

③ MASTER OUT jacks

These jacks output signals after volume adjustment by the master fader.

④ LINE input jacks (TS)

Use these input jacks to connect line level equipment.

For example, connect keyboards or audio devices. These can be used with 1/4-inch (unbalanced) phone plugs. If only the left LINE input jack (TS) channel is connected, it will be handled as a mono channel.

⑤ MIC/LINE input jacks

These input jacks have built-in mic preamps.

Connect mics, keyboards and guitars to them. These can be used with both XLR and 1/4-inch (balanced or unbalanced) phone plugs.

⑥ LINE input jacks (RCA)

Use these input jacks to connect line level equipment.

For example, connect audio devices. These can be used with RCA pin connectors.

If both the RCA and TS LINE input jacks are connected, the TS input jacks will be used.

⑦ DC IN 12V AC adapter connector

Connect the included AC adapter here.

Installing L-20 Control

Install the dedicated L-20 Control app on an iPad.
This app can be used to operate the **L-20R**.

1. Use the iPad to scan the following 2D code, and install L-20 Control from the App Store.



Connecting the L-20R with an iPad

Pairing beforehand is necessary to use an iPad for control.

NOTE

Install the dedicated L-20 Control app on the iPad before connecting.

1. While the **L-20R** is off, connect a Zoom wireless adapter (e.g. BTA-1)
2. Turn the **L-20R** power on.

NOTE

Confirm that the output devices connected to the **L-20R** are turned off.

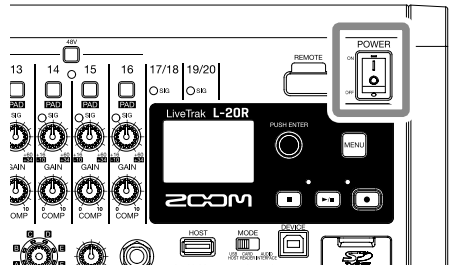

3. Launch the dedicated app on the iPad.
4. Make the connection on the app settings screen.

HINT



See the Operation Manual for app settings and operations.

Setting the date and time

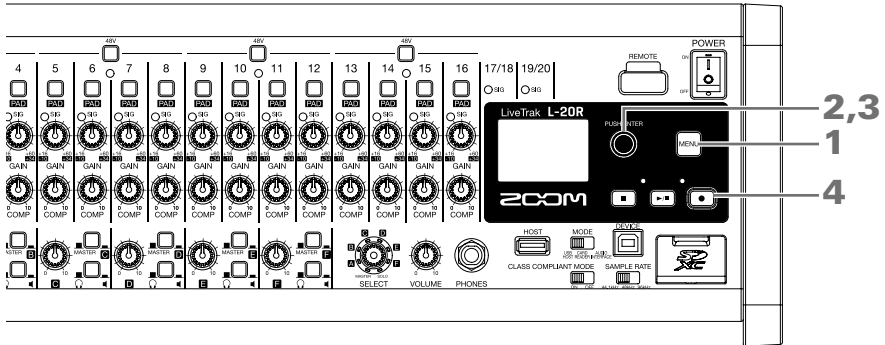

The first time you turn the power on after purchase, you must set the date/time.



1. Press .
2. Select SYSTEM > DATE/TIME.

Move cursor: Turn 
Confirm: Press 

3. Set the date and time.

Move cursor or change value: Turn 
Select item/confirm change: Press 

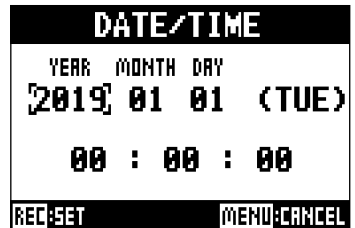

4. Press .

Functions

Mixer	The mono channels have high-quality mic preamps and compressors. Each channel can also have 3-band EQ, LOW CUT, PAN, polarity reversal, and send amounts for 2 effects set. You can also set the bus monitored through the PHONES jack to MASTER, A-F or SOLO. The master bus has a 15-band graphic equalizer.
Effects	The mixer includes 20 types of send-return effects in 2 groups. Parameters for each effect can be adjusted.
Scenes	This function enables saving up to nine sets of current mixer settings as scenes and recalling these saved settings at any time. The mixer settings can also be reset.
MONITOR OUT	The MONITOR OUT jacks can output 6 different monitor mixes, allowing different performers to receive mixes as they like. Each MONITOR OUT has its own switch to set whether it is connected to headphones or a speaker.
Recorder	The recorder can simultaneously record 22 tracks, including each channel and the master track, and simultaneously play 20 tracks. Recorded data is saved in 16/24-bit, 44.1/48/96 kHz WAV format and managed in units called projects. The following functions can be used with the recorder. <ul style="list-style-type: none"> • Recording, overdubbing and playing tracks • Adding marks and moving between them • Punching in/out • Mixing down (master track recording and playback) • Automatically starting recording when a set volume is exceeded • Pre-recording before recording starts
Projects	The following operations can be used with projects. <ul style="list-style-type: none"> • Selecting the folder where projects are saved • Selecting projects for playback • Changing project names • Deleting projects • Protecting projects • Checking project information • Saving projects to and loading them from USB flash drives • Checking, deleting and moving between marks
Audio files	The following operations can be used on audio files. <ul style="list-style-type: none"> • Deleting audio files • Exporting audio files to and loading them from USB flash drives
Metronome	The volume, sound and pattern can be changed and the metronome includes a precount function. The volume of each output jack can be set.
Audio interface	When used as a USB audio interface, it supports 22 ins and 4 outs when the sampling rate is 44.1/48 kHz.
Card reader	Use as a card reader is possible when connected to a computer.
Settings	Settings related to the recorder and SD cards can be made using the MENU button.
Recorder	Recording format settings Automatic recording settings Latency adjustment setting Playback settings Settings related to input signal recording sources
SD cards	Checking open space Resetting to factory settings Testing card performance
Other settings	Date and time setting Footswitch setting Changing the sampling rate Disabling the automatic power saving function Adjusting the display contrast
Restoring factory defaults	The unit can be restored to its factory default settings.
Firmware	You can check the firmware version and update it to the latest version.
Operation from an iPad	By connecting a Zoom wireless adapter (e.g. BTA-1) and using the L-20 Control app, operation from an iPad is possible.

See the Operation Manual for details.

Specifications

Input and output channels	Inputs	Mono (MIC/LINE)	16	
		Stereo (LINE)	2	
	Outputs	MASTER OUT	1	
		MONITOR OUT	6	
		PHONES	1	
Inputs	Mono (MIC/LINE)	Type	XLR/TRS combo jacks (XLR: 2 HOT, TRS: TIP HOT)	
		Input gain	PAD OFF: +16 – +60 dB PAD ON: –10 – +34 dB Hi-Z ON: +6 – +50 dB	
		Input impedance	XLR: 3 k Ω TRS: 10 k Ω /1 M Ω (when Hi-Z ON)	
		Maximum input level	PAD OFF: 0 dBu (at 0 dBFS) PAD ON: +26 dBu (at 0 dBFS)	
			Phantom power	+48 V
	Stereo (LINE)	Type	TS phone/RCA pin jacks (unbalanced)	
		Maximum input level	+14 dBu	
	Outputs	MASTER OUT	Type	XLR jacks (balanced)
Maximum output level			+14.5 dBu	
Output impedance			100 Ω	
MONITOR OUT A-F (with balanced output connected to monitor speakers)		Type	TRS phone jacks (balanced)	
		Maximum output level	+14.5 dBu	
		Output impedance	100 Ω	
MONITOR OUT A-F (with unbalanced output connected to headphones)		Type	Standard stereo phone jack	
		Maximum output level	42 mW + 42 mW (60 Ω load)	
		Output impedance	100 Ω	
PHONES		Type	Standard stereo phone jack	
	Maximum output level	42 mW + 42 mW (60 Ω load)		
		Output impedance	100 Ω	
Buses	MASTER		1	
	MONITOR		6	
	SEND EFX		2	
Channel strip	COMP			
	LOW CUT		40 – 600 Hz, 12 dB/OCT	
	EQ		HIGH: 10 kHz, \pm 15 dB, shelving MID: 100 Hz – 8 kHz, \pm 15 dB, peaking LOW: 100 Hz, \pm 15 dB, shelving	
	PHASE			
	Send effects		20 types	
Recorder	Maximum simultaneous recording tracks		22 at 44.1/48/96 kHz	
	Maximum simultaneous playback tracks		20	
	Recording formats		44.1/48/96 kHz, 16/24-bit, mono/stereo WAV	
	Recording media		4–32 GB cards compatible with the SDHC specification (class 10 or higher) 64–512 GB cards compatible with the SDXC specification (class 10 or higher)	
Audio interface	44.1/48 kHz		Recording: 22 channels Playback: 4 channels	
	Bit depth		24-bit	
	Interface		USB 2.0	
Card reader	USB 2.0 High Speed mass storage class			
USB HOST	USB 2.0 High Speed			
Sampling frequencies	44.1/48/96 kHz			
Frequency characteristics	44.1 kHz: –1.0 dB, 20 Hz – 20 kHz 96 kHz: –3.0 dB, 20 Hz – 40 kHz			
Equivalent input noise	Actual measurements: –128 dB EIN (IHF-A) at +60 dB/150 Ω input			
Display	LCD with backlight (128x64 resolution)			
Power supply	AD-19 AC adapter (DC12 V/2 A)			
Power consumption	24 W maximum			
External dimensions	438 mm (W) x 158.2 mm (D) x 151.7 mm (H)			
Weight (main unit only)	2.49 kg			



ZOOM CORPORATION

4-4-3 Kanda-surugadai, Chiyoda-ku, Tokyo 101-0062 Japan

www.zoom.co.jp