

L-12

LiveTrak

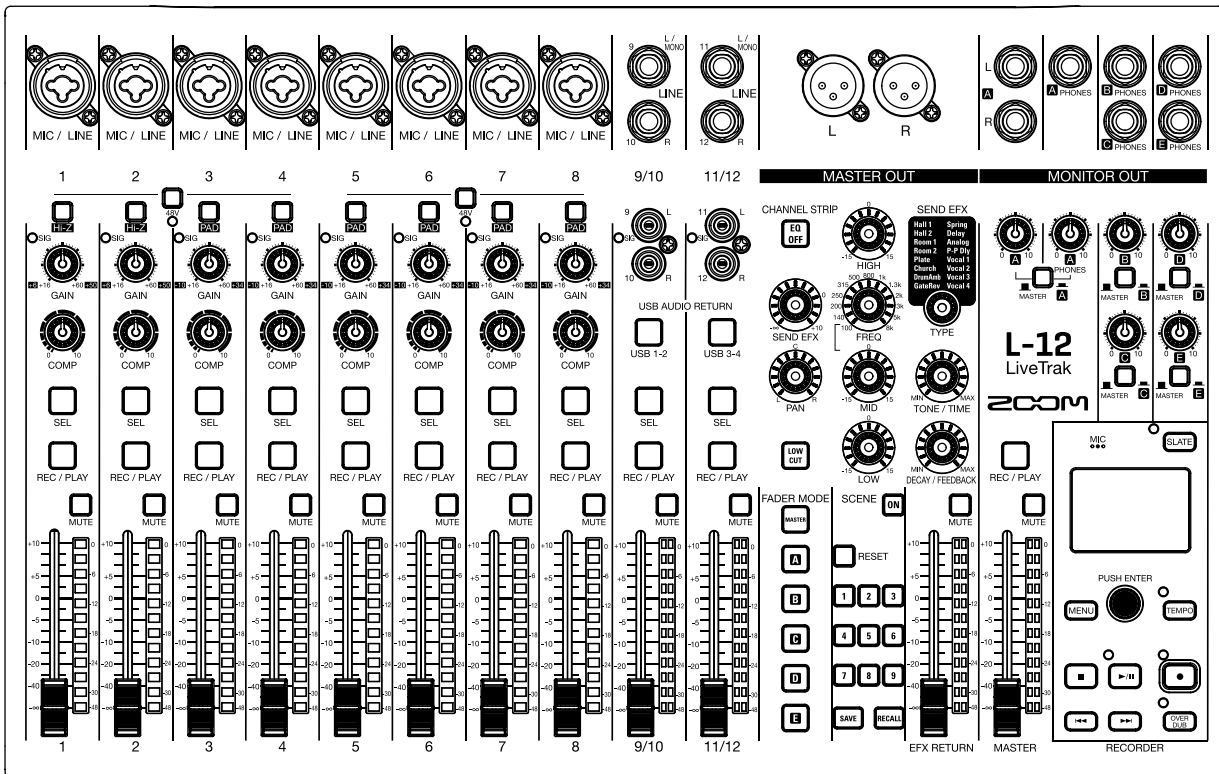

Operation Manual

You must read the Usage and Safety Precautions before use.



© 2017 ZOOM CORPORATION

Copying or reprinting this manual in part or in whole without permission is prohibited.



Product names, registered trademarks and company names in this document are the property of their respective companies. All trademarks and registered trademarks in this document are for identification purposes only and are not intended to infringe on the copyrights of their respective owners.

Usage and Safety Precautions

In this operation manual, symbols are used to highlight warnings and cautions that you must read to prevent accidents. The meanings of these symbols are as follows.

 Warning Something that could cause serious injury or death	 Caution Something that could cause injury or damage to the equipment
--	---

Other symbols used

 An action that is mandatory	 An action that is prohibited
--	--

Warning

■ Operation using an AC adapter

- ⓘ Never use any AC adapter other than a ZOOM AD-19.
- ⊘ Do not do anything that could exceed the ratings of outlets and other electrical wiring equipment.
Before using the equipment in a foreign country or other region where the electrical voltage differs, always consult with a shop that carries ZOOM products and use the appropriate AC adapter.

■ Alterations

- ⊘ Do not open the case or modify the product.

Caution

■ Product handling

- ⓘ Do not drop, bump or apply excessive force to the unit.
- ⓘ Be careful not to allow foreign objects or liquids to enter the unit.

■ Operating environment

- ⊘ Do not use in extremely high or low temperatures.
- ⊘ Do not use near heaters, stoves and other heat sources.
- ⊘ Do not use in very high humidity or where it could be splashed by water.
- ⊘ Do not use in places with frequent vibrations.
- ⊘ Do not use in places with much dust or sand.

■ AC adapter handling

- ⓘ When disconnecting the power plug from an outlet, always pull on the plug itself.
- ⓘ Disconnect the power plug from the outlet when the unit will not be used for a long time and whenever there is lightning.

■ Connection cables and input/output jacks

- ⓘ Always turn the power OFF for all equipment before connecting any cables.
- ⓘ Always disconnect all connection cables and the AC adapter before moving the unit.

■ Volume

- ⊘ Do not use at a loud volume for a long time.

■ Interference with other electrical equipment

In consideration of safety, the **L-12** has been designed to minimize its emission of electromagnetic waves and to suppress interference from external electromagnetic waves. However, equipment that is very susceptible to interference or that emits powerful electromagnetic waves could result in interference if placed nearby. If this occurs, place the **L-12** and the other device farther apart.

With any type of electronic device that uses digital control, including the **L-12**, electromagnetic interference could cause malfunction, corrupt or destroy data and result in other unexpected trouble. Always use caution.

■ Cleaning

Use a soft cloth to clean the exterior of the unit if it becomes dirty. If necessary, use a damp cloth that has been wrung out well to wipe it. Never use abrasive cleansers, wax or solvents such as alcohol, benzene or paint thinner.

■ Breakdown and malfunction

If the unit becomes broken or malfunctions, immediately disconnect the AC adapter, turn the power off and disconnect other cables. Contact the store where you bought the unit or ZOOM service with the following information: product model, serial number and specific symptoms of breakdown or malfunction, along with your name, address and telephone number.

■ Copyrights

- Windows® is a registered trademark of Microsoft® Corporation.
- Macintosh, Mac OS and iPad are trademarks or registered trademarks of Apple Inc.
- The SD, SDHC and SDXC logos are trademarks.
- Other product names, registered trademarks and company names in this document are the property of their respective companies.

Note: All trademarks and registered trademarks in this document are for identification purposes only and are not intended to infringe on the copyrights of their respective owners.

Recording from copyrighted sources, including CDs, records, tapes, live performances, video works and broadcasts, without permission of the copyright holder for any purpose other than personal use is prohibited by law. Zoom Corporation will not assume any responsibility related to infringements of copyrights.

■ Note about the Auto Power Off function

The power will automatically turn off if unused for 10 hours. If you want the power to stay on always, refer to [Disabling the automatic power saving function](#).

FCC regulation warning (for U.S.A.)

Note: This equipment has been tested and found to comply with the limits for a Class B digital device, pursuant to Part 15 of the FCC Rules. These limits are designed to provide reasonable protection against harmful interference in a residential installation. This equipment generates, uses and can radiate radio frequency energy and, if not installed and used in accordance with the instructions, may cause harmful interference to radio communications. However, there is no guarantee that interference will not occur in a particular installation. If this equipment does cause harmful interference to radio or television reception, which can be determined by turning the equipment off and on, the user is encouraged to try to correct the interference by one or more of the following measures:

- Reorient or relocate the receiving antenna.
- Increase the separation between the equipment and receiver.
- Connect the equipment into an outlet on a circuit different from that to which the receiver is connected.
- Consult the dealer or an experienced radio/TV technician for help.

For EU Countries

 Declaration of Conformity

Introduction

Thank you very much for purchasing a ZOOM LiveTrak **L-12**. The **L-12** has the following features.

12-channel digital mixer & multitrack recorder

The **L-12** combines a digital mixer with 12 total input channels (8 mono and 2 stereo), a multitrack recorder that can simultaneously record up to 14 tracks, and a 14-in/4-out USB audio interface. Compact and lightweight, this digital mixer is easy to transport and can even be used with PA systems for live performances in rehearsal studios, cafés and other small venues.

High-quality mic preamps

The **L-12** has high-quality mic preamps built-in for 8 channels. The high-quality analog inputs, which can provide +48 V phantom power, have a -128 dBu EIN rating and +60 dB maximum input gain. In addition, channels 1 and 2 also support Hi-Z input, while channels 3 to 8 have PAD functions (26 dB attenuation), enabling them to accept high levels of input.

5 MONITOR OUT channels

In addition to the MASTER OUT, the **L-12** also has 5 MONITOR OUT channels. The MONITOR OUT mixes can be set separately for each output. Since these support headphone output, headphones are all that are needed to send different mixes to each performer.

Digital mixer that can be operated intuitively

Opening menus is not necessary with the **L-12**. Every mixer parameter can be controlled with knobs and keys just like an analog mixer. Each channel has a 3-band EQ, and the mono channels have compressor functions. The mixer also includes high-quality send effects. In addition, up to 9 mixer status scenes can be saved in the unit.

Recorder can simultaneously record 14 tracks and play 12 tracks

The **L-12** can simultaneously record every channel and the master fader stereo signal output for a total of 14 tracks. Since the recorded data is saved in 16/24-bit, 44.1/48/96 kHz WAV format, the files can easily be copied to a computer and used in a DAW. In addition, overdubbing and punching in/out can be done as expected with a multitrack recorder.

14-in/4-out USB audio interface

The **L-12** can be used as a 14-in/4-out USB audio interface. The signals from each input and the master fader output can be recorded in a DAW. In addition, signals output from a computer can also be assigned to a stereo channel.

Class compliant mode, which enables connection with iOS devices, is also supported.

Contents

Usage and Safety Precautions

Introduction

Names and functions of parts

Top

Rear panel

Equipment connection example

Live PA system

Display overview

Home Screen

Turning the unit on/off

Turning the unit on

Turning the power off

Using the MENU screen

Mixer

Outputting input sounds from output devices

Adjusting the tone and panning

Using the built-in effects

Using scene functions

Setting signals output from MONITOR OUT A–E

Recording and playback

Preparing to record

Recording and playing tracks

Adding marks

Redoing parts of recordings (punching in/out)

Mixing down tracks

Recording automatically

Capturing audio before recording starts

Selecting the folder where projects are saved

Selecting projects for playback

Using the metronome

Enabling the metronome

Changing metronome settings

Using the slate mic

Recording with the slate mic

Changing slate mic settings

Projects

Changing project names

Deleting projects

Protecting projects

Checking project information

Saving projects to USB flash drives

Importing projects from USB flash drives

Managing marks

Audio files

Deleting audio files

Exporting audio files to USB flash drives

Importing audio files from USB flash drives

Using audio interface functions

Installing the driver

Connecting to a computer

Inputting return signals from the computer to a stereo channel

Using card reader functions

Recording and playback settings

Changing the recording format

Changing automatic recording settings

Showing recording levels on level meters

Enabling latency adjustment

Changing the playback mode

SD card settings

Checking the open space on SD cards

Formatting SD cards

Testing SD card performance

Various settings

Setting the date and time

Setting the footswitch

Changing the sampling rate

Disabling the automatic power saving function

Adjusting the display contrast

Restoring settings to factory defaults

Checking the firmware versions

Updating the firmware

Troubleshooting

Specifications

Send effects specifications

Mixer block diagram

Names and functions of parts

Top

Input channel section

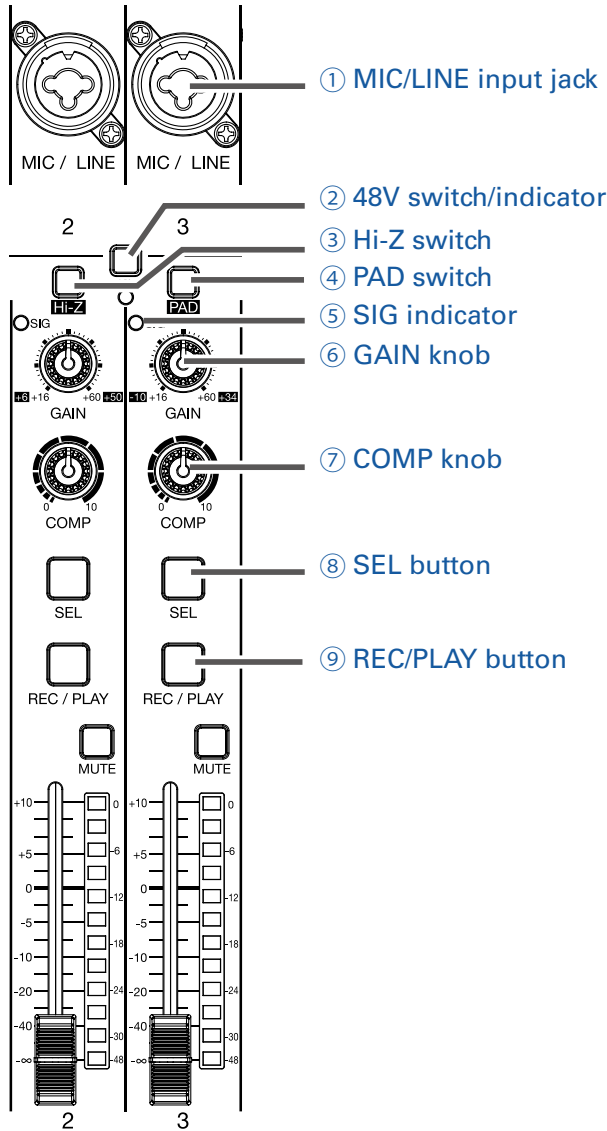

① MIC/LINE input jack

These input jacks have built-in mic preamps. Connect mics, keyboards and guitars to them. These can be used with both XLR and 1/4-inch (balanced or unbalanced) phone plugs.

② 48V switch/indicator

This turns +48V phantom power on or off. Turn this on () to supply phantom power to MIC/LINE input jacks 1–4 (or 5–8).

The indicator lights when the switch is on.

③ Hi-Z switch

Use to switch the input impedance of MIC/LINE input jack 1 (or 2).

Turn it on () when connecting a guitar or bass guitar.

④ **PAD switch**

This attenuates (reduces) the input signal of the equipment connected to the MIC/LINE input jack by 26 dB.

Turn this on () when connecting line level equipment.

⑤ **SIG indicator**

This indicator shows the signal level after adjustment by the GAIN knob.

The indicator color changes according to the signal level.

Lit red: -3 dB

Lit green: -48 to -3 dB

⑥ **GAIN knob**

Use to adjust the input gain of the mic preamp.

The range of adjustment depends on the on/off status of the MIC/LINE input jack switch (Hi-Z on channels 1-2 or PAD on channels 3-8).

Jack	Adjustment range	
MIC/LINE input jack 1-2 (XLR)	+16 – +60 dB	
MIC/LINE input jack 1-2 (TRS)	Hi-Z off	+16 – +60 dB
	Hi-Z on (TS)	+6 – +50 dB
MIC/LINE input jack 3-8	PAD off	+16 – +60 dB
	PAD on	-10 – +34 dB

⑦ **COMP knob**

Use to adjust the amount of compression.

⑧ **SEL button**

Use to select a channel for parameter adjustment in the channel strip section.

Channels with lit SEL buttons are affected by channel strip section adjustments.

⑨ **REC/PLAY button**

Use this button to switch between recording input signals to the SD card and playing back an already recorded file from the SD card.

Status	Explanation
Lit red	Input signals will be recorded to the SD card after passing through the compressor.
Lit green	An already recorded file will be played back. Playback signals are input before the equalizer. In this state, signals from input jacks are disabled.
Unlit	Files will neither be recorded nor played back.

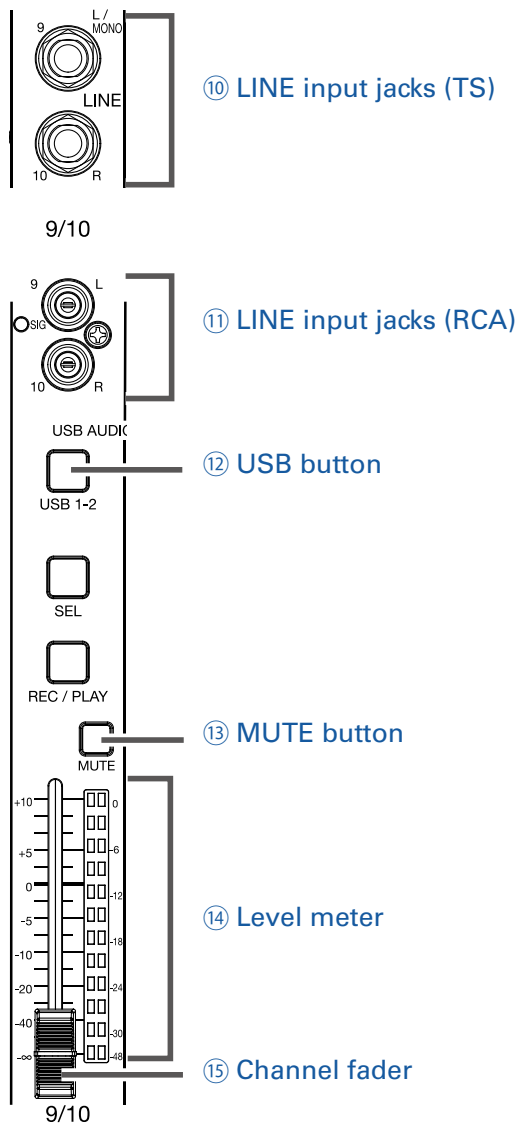

⑩ LINE input jacks (TS)

Use these input jacks to connect line level equipment. For example, connect keyboards or audio devices.

These can be used with 1/4-inch (unbalanced) phone plugs.

NOTE

If only the left LINE input jack (TS) channel is connected, it will be handled as a mono channel.

⑪ LINE input jacks (RCA)

Use these input jacks to connect line level equipment. For example, connect audio devices.

These can be used with RCA pin connectors.

NOTE

If both the RCA and TS LINE input jacks are connected, the TS input jacks will be used.

⑫ **USB button**

This switches the signals input to channels 9/10 (or 11/12).

Lit: audio return signal output from the computer

Unlit: LINE input jacks

NOTE

Connect the **L-12** to a computer as an audio interface. (→ [Connecting to a computer](#))

⑬ **MUTE button**

This mutes or unmutes signals.

To mute the channel, press this button to light it.

HINT

This has no effect on recording to the SD card.

⑭ **Level meter**

This shows the signal level after adjustment by the channel fader.

Ranges shown: -48 dB – 0 dB

NOTE

If the actual channel fader position differs from the channel fader position recalled using the scene function, for example, the level meter will show the recalled fader position.

⑮ **Channel fader**

This adjusts the channel signal level in a range from $-\infty$ to +10 dB.

CHANNEL STRIP section

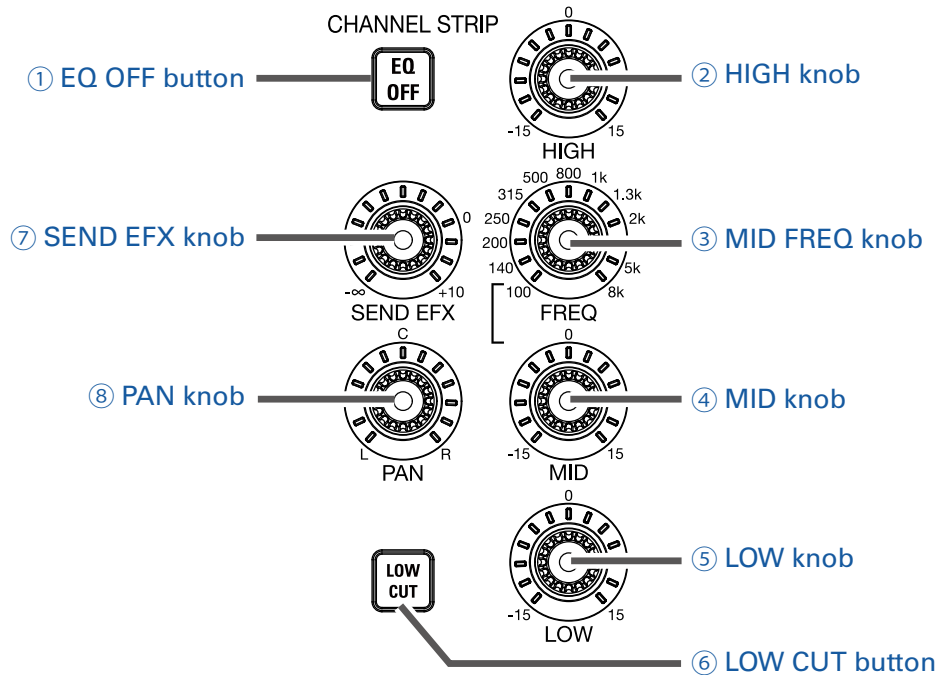

① EQ OFF button

When this button is lit, HIGH, MID, LOW and LOW CUT are bypassed.

② HIGH knob

This adjusts the boost/cut of high-frequency equalization.

Type: shelving

Gain range: -15 dB – +15 dB

Frequency: 10 kHz

③ MID FREQ knob

This adjusts the central frequency of the mid frequency equalization.

Frequency (in Hz): 100, 140, 200, 250, 315, 500, 800, 1k, 1.3k, 2k, 3k, 5k or 8k

④ MID knob

This adjusts the boost/cut of mid-frequency equalization.

Type: peaking

Gain range: -15 dB – +15 dB

Frequency: set by MID FREQ knob

⑤ LOW knob

This adjusts the boost/cut of low-frequency equalization.

Type: shelving

Gain range: -15 dB – +15 dB

Frequency: 100 Hz

⑥ LOW CUT button

This turns on/off the high-pass filter, which cuts low frequencies.

When ON, signals below 75 Hz are attenuated 12 dB/octave.

⑦ SEND EFX knob

The amount that can be sent to the SEND EFX bus can be set from $-\infty$ to +10 dB.

⑧ **PAN knob**

Use to adjust the channel position in the stereo field.

On a stereo input channel, this adjusts the volume balance between the left and right channels.

FADER MODE section

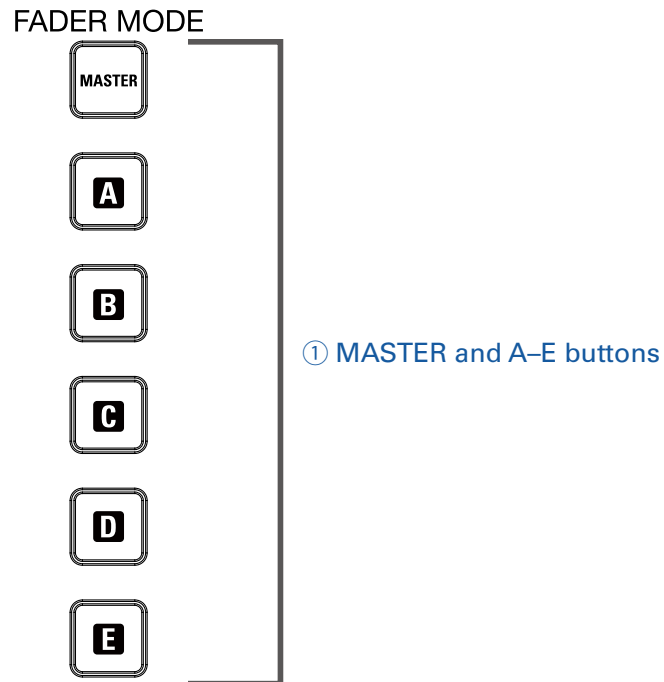

① MASTER and A-E buttons

These switch between the mixes output from the MASTER OUT and MONITOR OUT A-E jacks.

MASTER button: Use to show and adjust the mix output from the MASTER OUT jacks.

A-E buttons: Use to show and adjust the mixes output from the MONITOR OUT A-E jacks.

NOTE

The parameters that can have separate settings for the MASTER and A-E mixes are as follows.

- Fader positions (each channel)

SCENE section

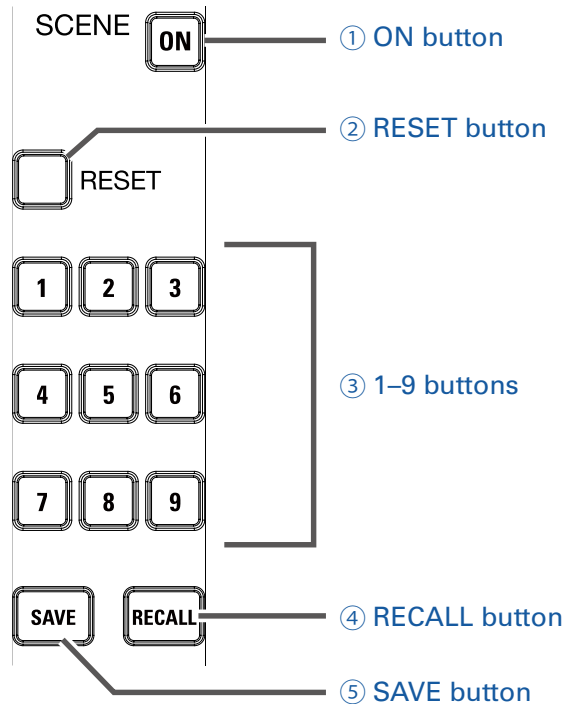

① ON button

Press this button, lighting it, to use the scene function

② RESET button

Press this button to reset the current mixer settings to the factory defaults.

③ 1-9 buttons

Use these buttons to select the scene to use to save the current mixer state and to load saved scenes. If the current mixer settings match the settings of a scene, the corresponding number button will light. This unit can save up to 9 scenes.

④ RECALL button

Use this button when loading scenes saved to buttons 1-9.

When this button is pressed, buttons 1-9 will blink if they have saved scenes and be unlit if they do not. To recall a saved scene, press a blinking button between 1 and 9. To cancel recalling a scene, press the RECALL button again.

⑤ SAVE button

Use this button when saving the current mixer settings to a scene.

When this button is pressed, buttons 1-9 will light if they have saved scenes and be blink if they do not. To save a scene, press a button between 1 and 9 to save it to that number. To cancel saving a scene, press the SAVE button again.

Send effect (SEND EFX) section

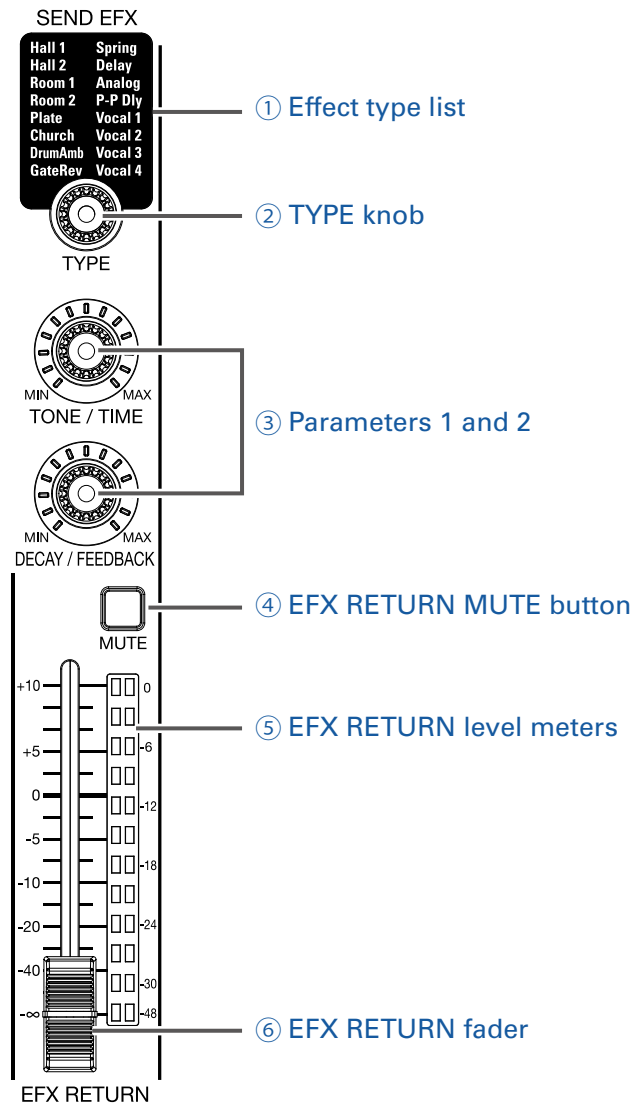

① Effect type list

This is the list of the built-in effects.

The name of the currently selected effect lights.

It blinks when being selected.

If some time passes without a different effect being selected, the previously selected effect will remain selected.

② TYPE knob

Use to select the built-in effect.

Turn this knob to select the effect type, and press it to confirm.

③ Parameters 1 and 2

Use these to adjust the parameters for the selected effect.

See [Send effects specifications](#) for the parameters of each effect.

④ EFX RETURN MUTE button

This mutes or unmutes the signal sent from the built-in effect.

To mute the signal, press this button to light it.

⑤ **EFX RETURN level meters**

These show the levels of the signals sent from the built-in effect to the master bus after adjustment by the EFX RETURN fader. Their range is from -48 dB to 0 dB.

⑥ **EFX RETURN fader**

This adjusts the levels of the signals sent from the built-in effect to the master bus in a range from $-\infty$ dB to +10 dB.

NOTE

If the actual channel fader position differs from the channel fader position recalled using the scene function, for example, the level meters will show the recalled fader position.

Output section

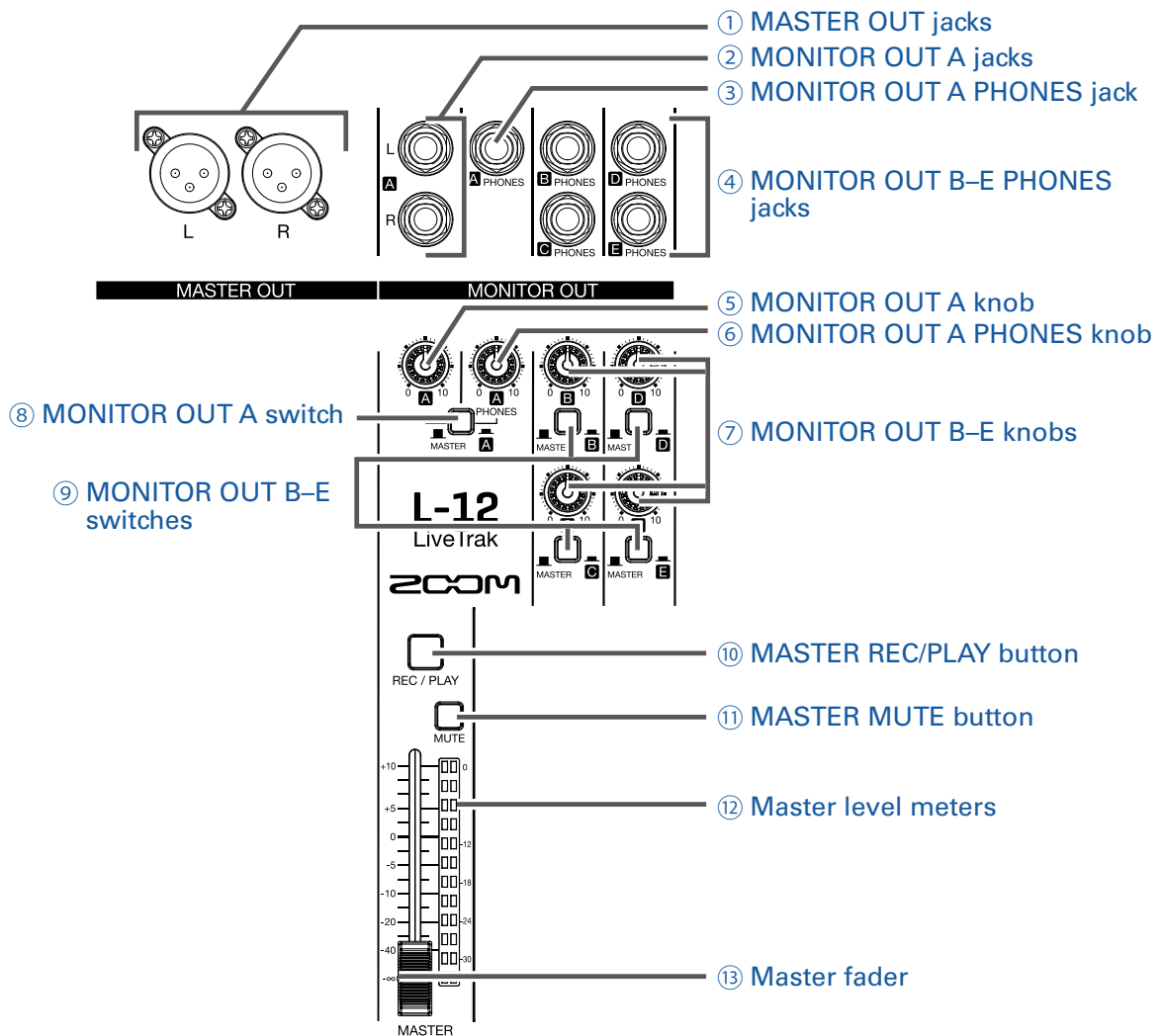

① MASTER OUT jacks

These jacks output signals after volume adjustment by the master fader. Connect them to a power amplifier, a PA system or speakers with built-in amplifiers, for example. These support balanced output with XLR connectors (2 HOT).

② MONITOR OUT A jacks

These jacks output signals after volume adjustment by the MONITOR OUT A knob. You can, for example, connect a monitoring system for the mixer operator here. These support balanced 1/4-inch jack phone output.

NOTE

The MONITOR OUT A jacks can be set to output the same signals as the MASTER OUT jacks or the signals set separately in the fader mode section. (→ [Selecting MONITOR OUT A-E output signals](#))

③ MONITOR OUT A PHONES jack

This headphone jack outputs signals after volume adjustment by the MONITOR OUT A PHONES knob.

NOTE

The MONITOR OUT A PHONES jack always outputs the same signals as the MONITOR OUT A jacks.

④ MONITOR OUT B–E PHONES jacks

These headphone jacks output signals after volume adjustments by the MONITOR OUT B–E PHONES knobs.

NOTE

The MONITOR OUT B–E jacks can be set to output the same signals as the MASTER OUT jacks or the signals set separately in the fader mode section. (→ [Setting signals output from MONITOR OUT A–E](#))

⑤ MONITOR OUT A knob

Use to adjust the volume of the signals output from the MONITOR OUT A jacks.

⑥ MONITOR OUT A PHONES knob

Use to adjust the volume of the signals output from the MONITOR OUT A PHONES jack.

⑦ MONITOR OUT B–E knobs

Use to adjust the volumes of the signals output from the MONITOR OUT B–E PHONES jacks.

⑧ MONITOR OUT A switch

This switches MONITOR OUT A output between the L/R jacks and the PHONES jack.

Status	Explanation
MASTER (<input type="checkbox"/>)	The same signals as the MASTER OUT are output.
A (<input type="checkbox"/>)	The signals set in the FADER MODE section are output.

⑨ MONITOR OUT B–E switches

These switch the signals output from the MONITOR OUT B–E PHONES jacks.

Status	Explanation
MASTER (<input type="checkbox"/>)	The same signals as the MASTER OUT are output.
B-E (<input type="checkbox"/>)	The signals set in the FADER MODE section are output.

⑩ MASTER REC/PLAY button

Use this button to switch between recording the signal input on the master bus to the SD card and playing back an already recorded file from the SD card.

Status	Explanation
Lit red	The signal will be recorded to the SD card after adjustment by the master fader.
Lit green	The playback signal of a file is inserted on the master bus. The REC/ PLAY buttons of other channels will be unlit at this time.
Unlit	Files will neither be recorded nor played back.

⑪ MASTER MUTE button

This mutes or unmutes the MASTER OUT jacks.

To mute the signals, press this button to light it.

⑫ Master level meters

These show the signal levels output from the MASTER OUT jacks in a range from –48 dB to 0 dB.

⑬ Master fader

This adjusts the signal levels output from the MASTER OUT jacks in a range from $-\infty$ to +10 dB.

NOTE

If the actual channel fader position differs from the channel fader position recalled using the scene function, for example, the level meters will show the recalled fader position. However, the position of the master fader is not shown when AUTO REC is activated.

RECORDER section

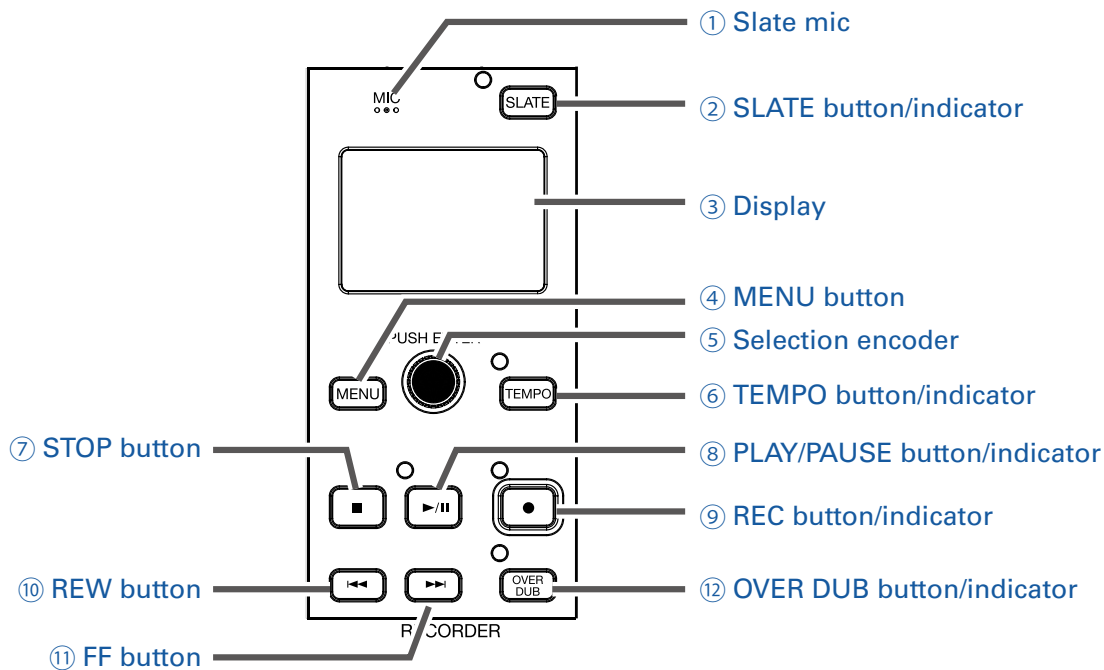

① Slate mic

This is a built-in mic for recording comments.

This mic input is active while the SLATE button is being pressed.

The input channel can be set to channels 1–12, MASTER, or all channels. (→ [Changing the slate mic routing](#))

② SLATE button/indicator

This activates the slate mic.

The slate mic is activated while this button is being pressed and its indicator is lit.

③ Display

This shows the recorder status and MENU screen.

④ MENU button

This opens the menu.

⑤ Selection encoder

Use this to change menus and values and to move between items.

Operation	Result
Turn when main recorder screen open	Search forward or backward in one-second increments.
Push when main recorder screen open	This sets a mark.
Turn when menu open	Move between parameters and change values.
Press when menu open	Confirm parameter value.

⑥ TEMPO button/indicator

This sets the tempo of the metronome built into the recorder.

Press this button to make the recorder detect the tempo from the average value.

During recording and playback, the indicator blinks at a tempo of 40.0–250.0 bpm.
See [Changing metronome settings](#) for metronome settings.

⑦ **STOP button**

This stops the recorder.

⑧ **PLAY/PAUSE button/indicator**

This starts and pauses recorder playback. The indicator shows the playback status as follows.

Status	Explanation
Lit green	The recorder is playing back.
Blinking green	Playback is paused.

⑨ **REC button/indicator**

This puts the recorder in recording standby. The indicator shows the recording status as follows.

Status	Explanation
Lit red	The recorder is recording or in recording standby.
Blinking red	Recording is paused.

⑩ **REW button**

Press to move to the previous mark.

If no mark is set, this moves to the beginning.

Press this button when at the beginning to move to the previous project.

Press and hold to search backward. (The longer you press, the faster the speed becomes.)

⑪ **FF button**

Press to move to the next mark.

If it is the last mark, this moves to the end of the file. Press this button again to move to the next project.

Press and hold to search forward. (The longer you press, the faster the speed becomes.)

⑫ **OVER DUB button/indicator**

Status	Explanation
Lit (ON)	Record by overwriting into the current project folder.
Unlit (OFF)	Create a new project folder and make a new recording.

Rear panel

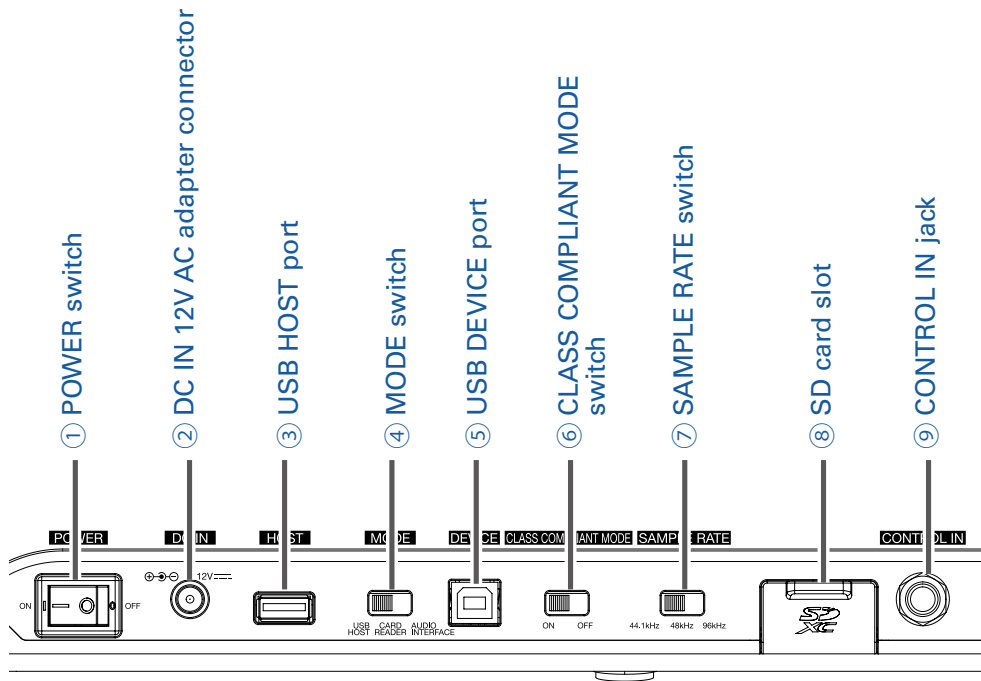

① POWER switch

This turns the **L-12** on and off.

Switch to — to turn the power on. Switch to ○ to turn the power off.

When the POWER switch setting is changed to OFF, the current mixer settings are automatically saved in the unit and in the settings file in the project folder on the SD card.

② DC IN 12V AC adapter connector

Connect the included AC adapter here.

③ USB HOST port

This USB 2.0 HOST port is for connecting USB flash drives.

Projects and audio files can be saved on and loaded from connected USB flash drives.

④ MODE switch

Set whether to use as a USB HOST, card reader or audio interface.

This cannot be changed after starting up.

⑤ USB DEVICE port

This USB 2.0 port is for connecting with a computer.

It will start up as a card reader or audio interface, depending on the MODE switch selection.

Card reader mode

Operating as an SD card reader, data can be exchanged with a computer.

Audio interface mode

Operating as an audio interface, audio data can be exchanged with a computer.

Inputs: The signals from channels 1–12 after they pass through their compressors and the master fader output signals are input to the computer.

Outputs: Outputs from the computer can be assigned to channels 9/10 and 11/12.

Use when connected to an iOS device is possible if the CLASS COMPLIANT MODE switch is set to ON.

⑥ **CLASS COMPLIANT MODE switch**

Use this to turn Class Compliant Mode ON/OFF.
Set it to ON when connected to an iOS device.

⑦ **SAMPLE RATE switch**

Set the sampling rate used by the unit.
This cannot be changed after starting up.

⑧ **SD card slot**

This slot is for SD cards.
The **L-12** supports SD, SDHC and SDXC card specifications.

HINT

You can test whether an SD card can be used with the **L-12**. (→ [Testing SD card performance](#))

⑨ **CONTROL IN jack**

A footswitch (ZOOM FS01) can be connected here.
The footswitch can be assigned to one function:
starting/stopping recorder playback, manually punching in/out or muting/unmuting the built-in effect. (→ [Setting the footswitch](#))

Equipment connection example

Live PA system

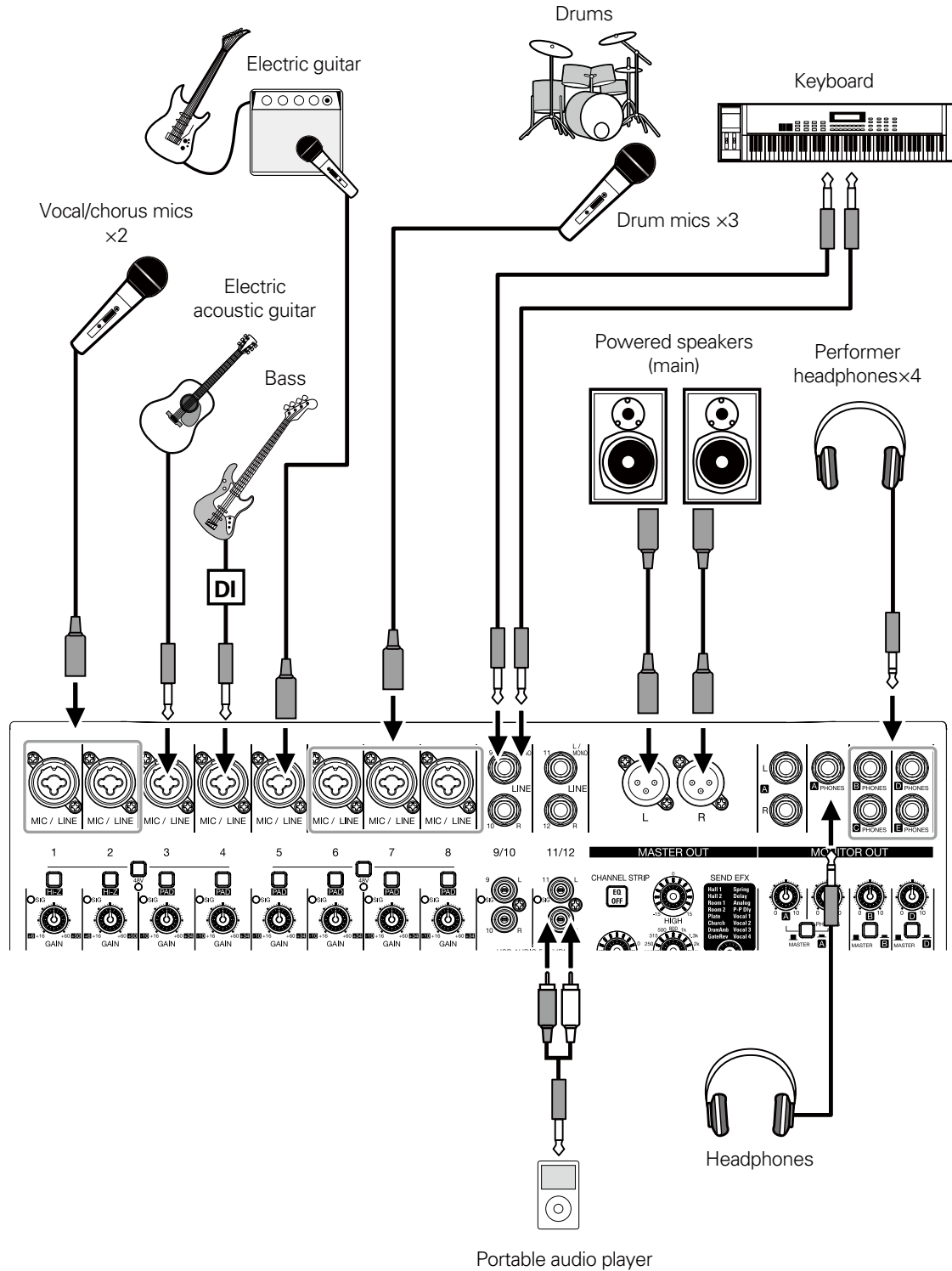

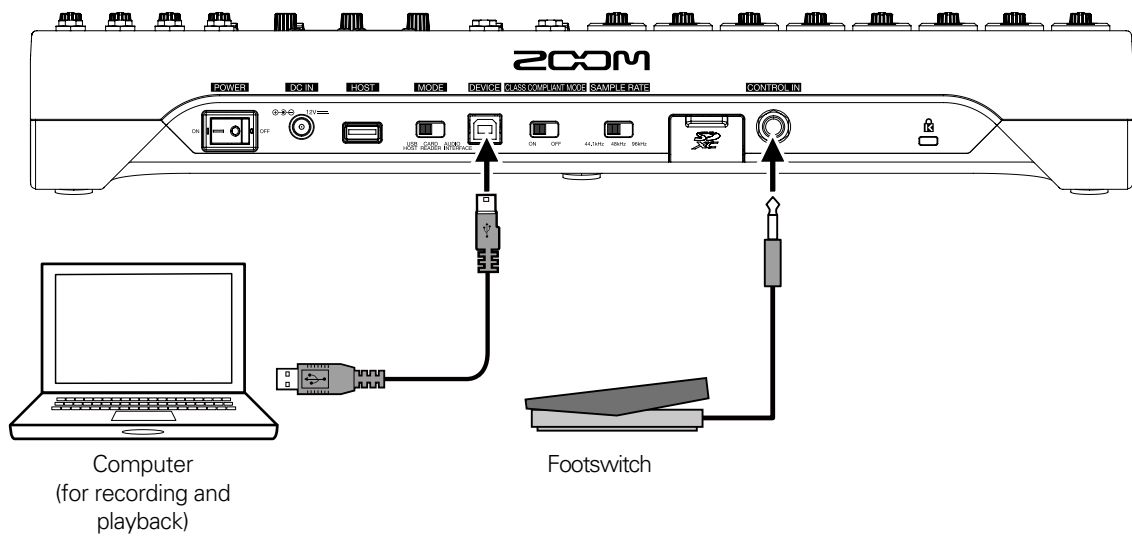

Display overview

Home Screen

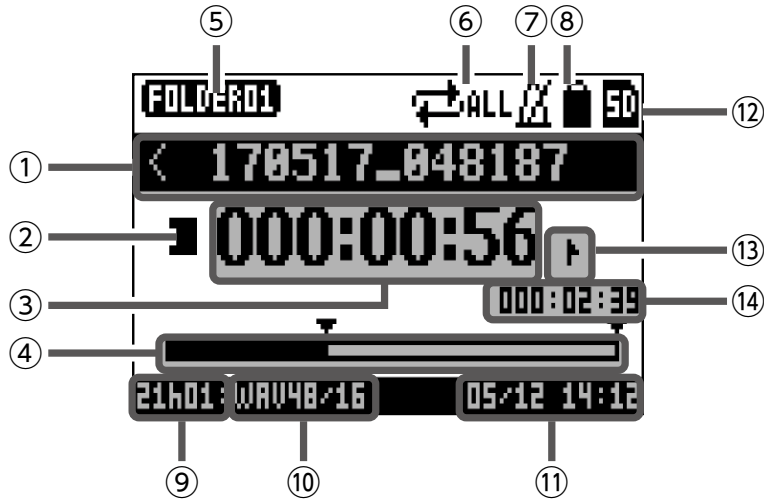

No	Item	Explanation
①	Project name	This shows the project name. "<" appears if there is another project before this one in the folder. ">" appears if there is another project after this one in the folder.
②	Status icon	This shows the status as follows. <input type="checkbox"/> : Stopped <input type="checkbox"/> : Paused <input checked="" type="checkbox"/> : Recording <input checked="" type="checkbox"/> : Playing back
③	Counter	This shows the hour: minute: second.
④	Progress bar	This bar shows the amount of time in the project from beginning to end.
⑤	Folder name	The folder where the project is saved will be shown as FOLDER01 – FOLDER10.
⑥	PLAY MODE icon	This shows the PLAY MODE setting.(→ Changing the playback mode)
⑦	Metronome icon	This is shown when the metronome is enabled. (→ Enabling the metronome)
⑧	Project protection icon	This is shown when project protection is enabled.(→ Protecting projects)
⑨	Remaining recordable time	This shows the remaining recordable time. This will change automatically according to the number of channels that have recording enabled with <input type="checkbox"/> <small>REC/PLAY*</small>
⑩	Recording file format	This shows the recording file format used by the recorder.
⑪	Current date and time	This shows the current date and time.
⑫	SD card icon	This is shown when an SD card is being recognized.
⑬	Mark	This shows the mark number and the status as follows. <input checked="" type="checkbox"/> : at mark (mark added at counter location) <input type="checkbox"/> : not at mark (mark not added at counter location)
⑭	Longest file time in project	This shows the length of the longest file in the project.

Turning the unit on/off

Turning the unit on

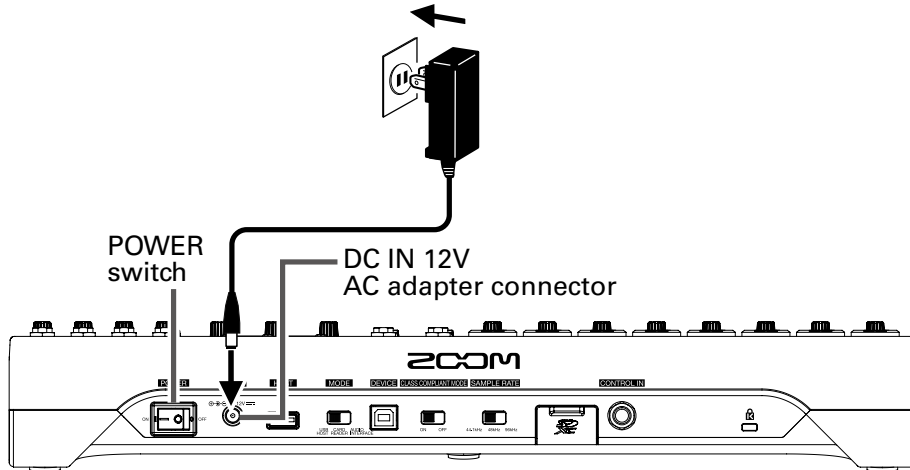

GAIN knob

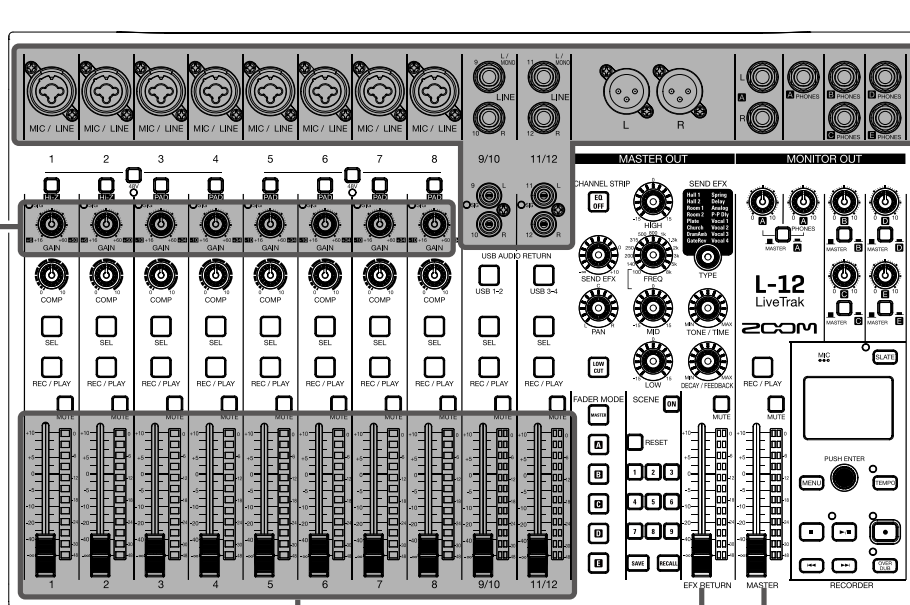

Input/Output jacks

Channel faders

Master fader

EFX RETURN fader

1. Confirm that the output devices connected to the **L-12** are turned off.

2. Confirm that  is set to OFF.

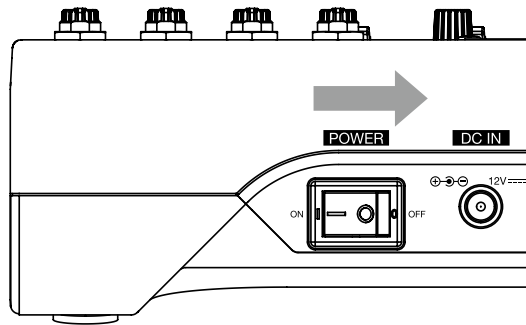

3. Plug the AD-19 adapter designed for this unit into an outlet.

4. Set all  knobs and faders to their minimum values.

5. Connect instruments, mics, speakers and other equipment.



HINT

Equipment connection example (→ [Equipment connection example](#))

6. Set  to ON.

7. Turn on the output devices connected to the **L-12**.

NOTE

- When using a passive guitar or bass guitar, connect it to channel 1 or 2, and turn  on. (→ [Top](#))
- When using a condenser mic, turn  on. (→ [Top](#))
- The power will automatically turn off if the **L-12** is unused for 10 hours. If you want the power to stay on always, disable the automatic power saving function (→ [Disabling the automatic power saving function](#))

Turning the power off

1. Minimize the volume of devices connected to the **L-12**.
2. Turn off the power of output devices connected to the **L-12**.
3. Set **POWER**  to OFF.
The following screens appear and the power turns off.



NOTE

When the power is turned off, the current mixer settings are saved in the project on the SD card. If they cannot be saved to the SD card, they will be saved in the unit.

Using the MENU screen

Recorder function settings, for example are made for the **L-12** using the MENU screen. This is an explanation of the basic menu operations.

Open the menu: Press 

This opens the MENU screen.

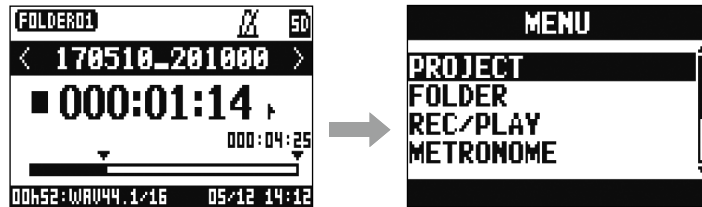

Select menu items and parameters: Turn 

This moves the cursor.

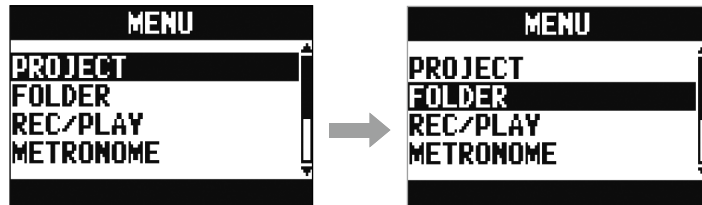

Confirm menu items and parameters: Press 

This opens the selected MENU screen or parameter setting screen.

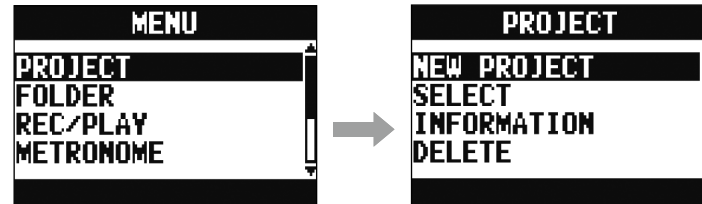

Return to previous screen: Press 

This opens the selected MENU screen or parameter setting screen.

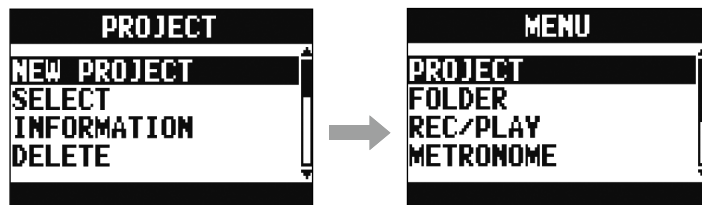

On the following pages, menu screen operations are shown in the following way.
For example, "After selecting 'METRONOME' on the MENU screen, select 'CLICK'" becomes:

Select MENU > METRONOME > CLICK

Mixer

Outputting input sounds from output devices

Outputting sound from speakers

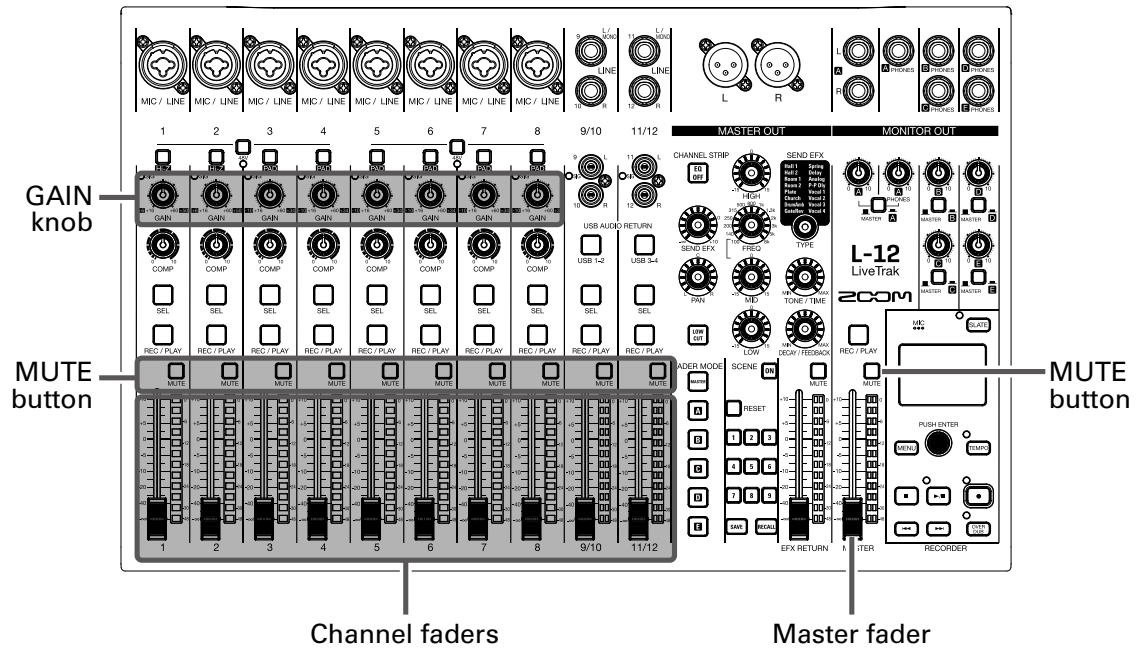

1. Use  to adjust the input signals while inputting sound from instruments and mics.

NOTE

Set them so that SIG indicators do not light red.



2. Turn  off (unlit) for the MASTER and the channels with sound you want to output.
3. Set the MASTER fader to 0.
4. Use the channel faders to adjust the volumes.
5. Use the MASTER fader to adjust the overall volume.

Outputting sound from headphones

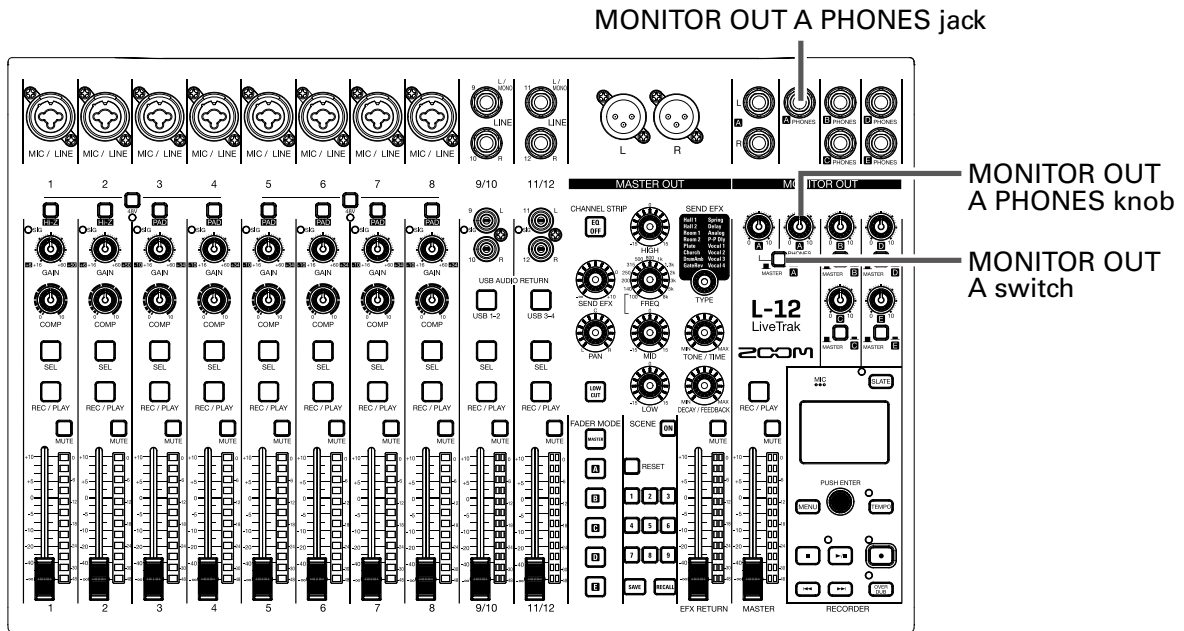



1. Connect headphones to the MONITOR OUT PHONES A jack.

2. Set  to MASTER ().



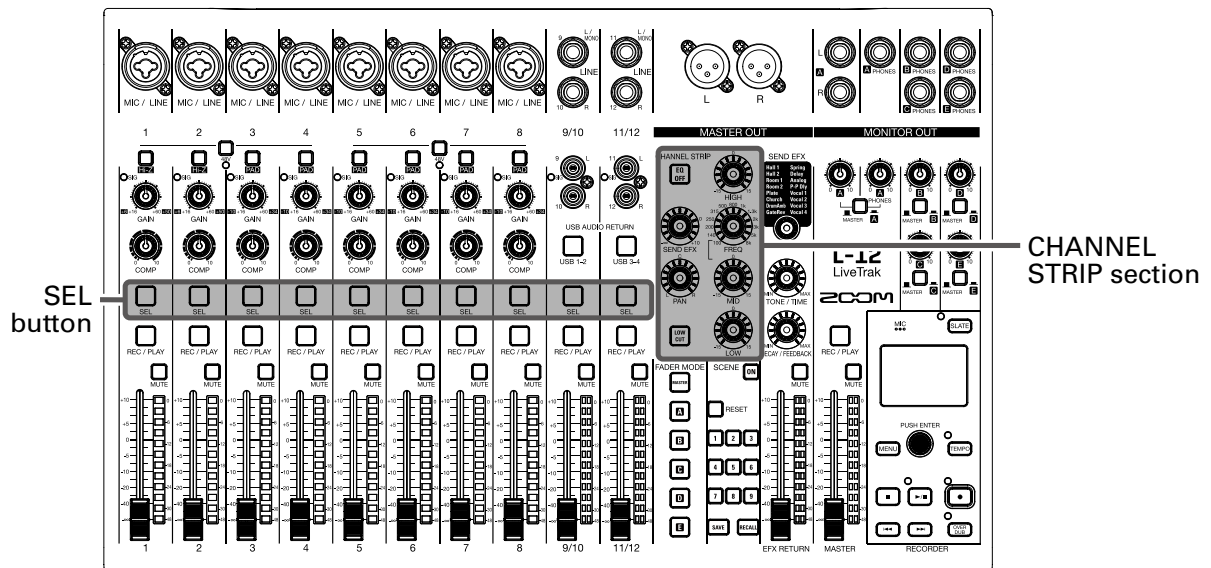

3. Use  to adjust the volume.

Adjusting the tone and panning



1. Press  to light it for the channel for which you want to adjust tone and panning.

2. Use the knobs and buttons in the channel strip section to adjust the tone and panning.

Adjusting the tone:  ,  ,  ,  , 

Adjusting the panning: 

NOTE

- Press  to light it, turning off all equalization at once. This will bypass HIGH, MID, LOW and LOW CUT settings.
- Using the compressor (→ [Input channel section](#))



HINT

Details about knobs and buttons (→ [CHANNEL STRIP section](#))

Using the built-in effects

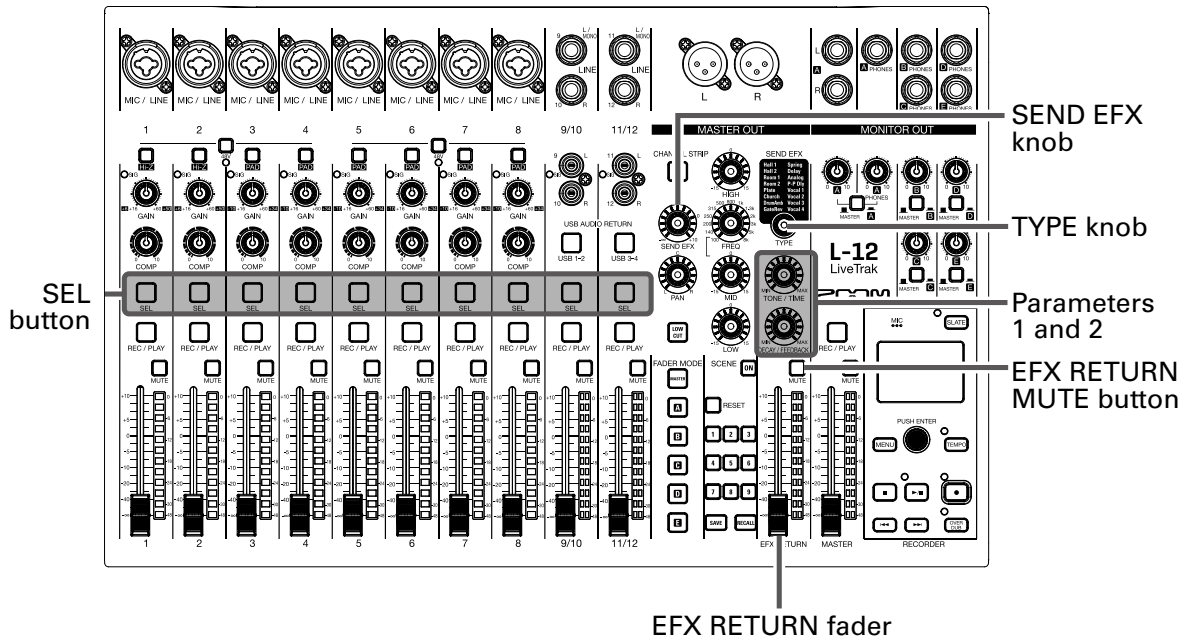
The **L-12** has 16 types of send effects



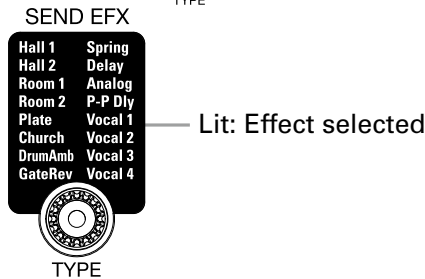

1. Turn  to select the effect type, and press  to confirm.





2. Press  to turn it off, unmuting the EFX RETURN.

3. Set the EFX RETURN fader to 0.



4. Press the  for the channel that you want to use the effect on to light it.

5. Use  to adjust the amount for each channel.

6. Use the EFX RETURN fader to adjust the overall effect amount.

7. Use  and  to adjust the send effect parameters.

NOTE

See [Send effects specifications](#) for the parameters of each effect that can be adjusted by  and .

Using scene functions

The scene function can be used to save up to nine sets of current mixer settings as scenes and to recall these saved settings at any time.

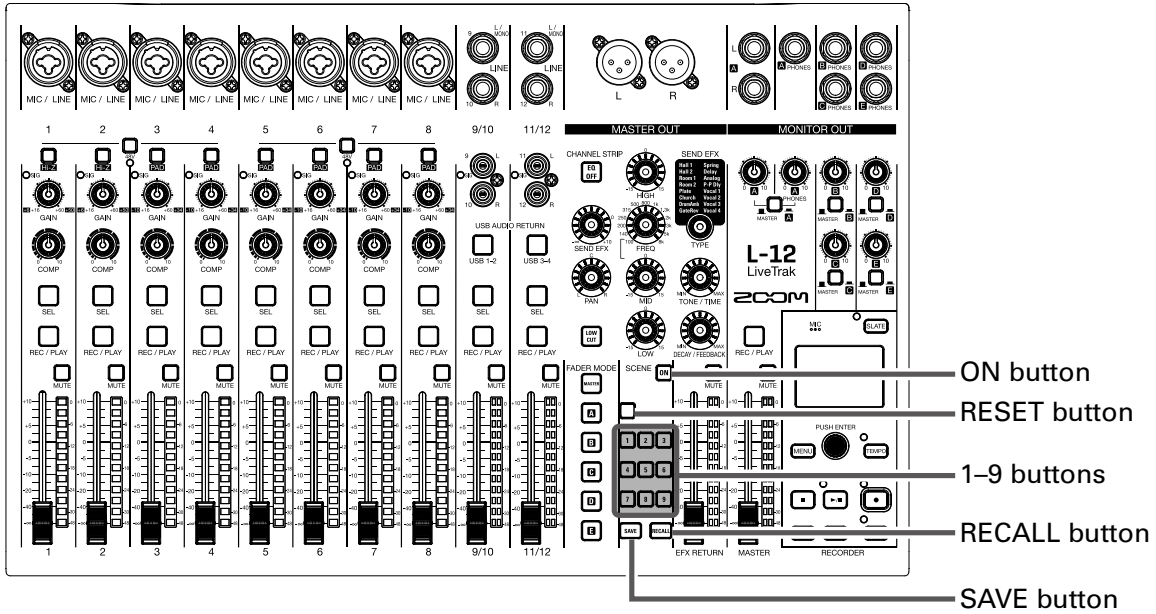

Saving scenes

1. Click **ON** so that it lights.
This enables the scene function.
2. Press **SAVE**.
Buttons **1** – **9** will light if they have saved scenes and blink if they do not.
Press **SAVE** again if you do not want to save a scene.
3. Press the button where you want to save the scene.

NOTE



- Nine scenes are saved in the unit. (→ [SCENE section](#))
- If a button that already has a scene saved is selected, that scene will be overwritten.
- The following items are saved with scenes.
 - Fader positions (each channel, SEND EFX, MASTER)
 - MUTE ON/OFF (each channel, SEND EFX, MASTER)
 - EQ OFF
 - LOW CUT ON/OFF
 - EQ HIGH
 - EQ MID
 - EQ MID FREQ
 - EQ LOW
 - SEND EFX
 - PAN
 - SEND EFXTYPE
 - SEND EFX parameters 1 and 2
 - USB button setting

Recalling scenes

1. Click  so that it lights.

This enables the scene function.

2. Press .

Buttons  –  will blink if they have saved scenes and be unlit if they do not.

Press  again if you do not want to recall a scene.

3. Press the button for the scene you want to recall.

The scene for the selected number is recalled.

NOTE

If the actual channel fader position differs from the channel fader position shown, the volume will not change until the fader is moved to the same position. (→ [Input channel section](#))

Resetting mixer settings

1. Click ON so that it lights.

This enables the scene function.

2. Press RECALL .

Buttons 1 – 9 will blink if they have saved scenes and be unlit if they do not.

Press RECALL again if you do not want to reset the settings.

3. Press RESET .

The current mixer settings are reset to their factory defaults.

Setting signals output from MONITOR OUT A-E

The MONITOR OUT A-E jacks can be set to output the same mix as the MASTER OUT or different mixes.

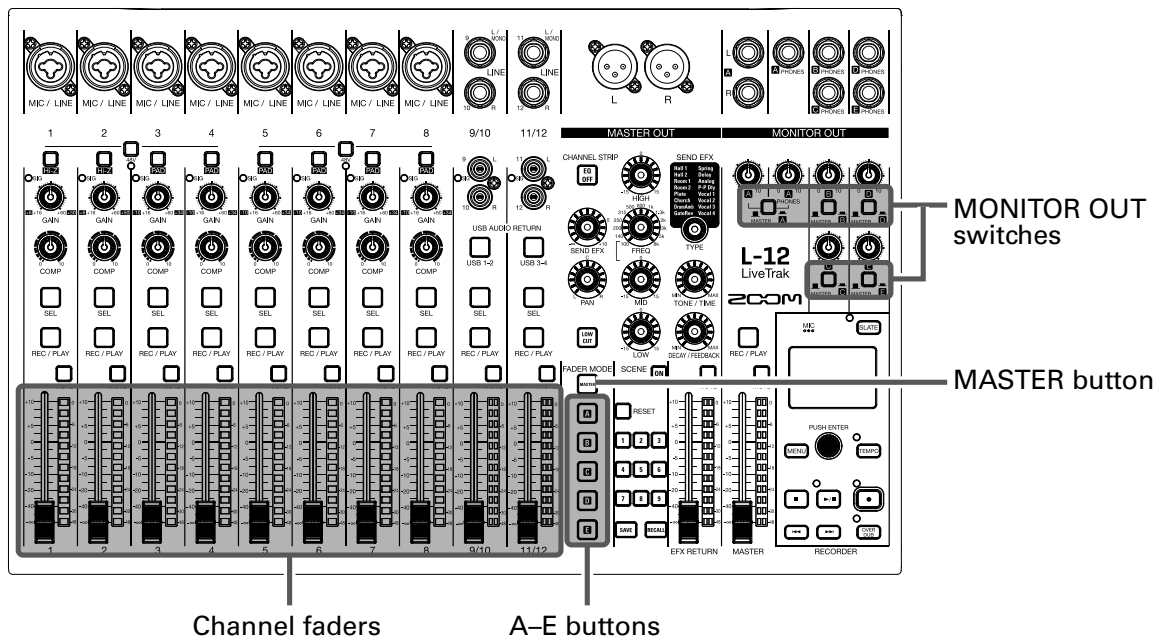

Adjusting the MONITOR OUT A-E mixes

1. Press an **A** – **E** button to select the output to mix.

The selected output button lights and operation of all the channel faders is enabled.

NOTE

The level meters show the fader positions. If the actual channel fader position differs from the channel fader position shown, the volume will not change until the fader is moved to the same position.

2. Use the channel faders to adjust the volumes.

Selecting MONITOR OUT A–E output signals

1. Use the MONITOR OUT switch for an output to select its output signal.

To output a mix set using MONITOR OUT A–E:

Set MONITOR OUT switch to A–E ()

To output the same mix as the MASTER:



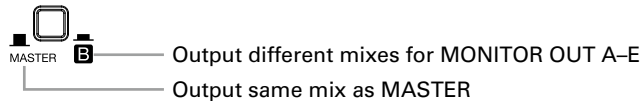

Set MONITOR OUT switch to MASTER ()



NOTE

- Each output mix is saved with the scene and project.
- MONITOR OUT A–E do not output send-return effect signals.
- The parameters that can have separate settings for the MASTER and MONITOR OUT A–E are as follows.
 - Fader positions (each channel)

Copying a mix

1. While pressing the button ( or ) for the output you want to copy for at least 2 seconds, press a blinking copy destination button ( or ).

This copies the mix from the source to the destination.

Recording and playback

Preparing to record

Inserting SD cards

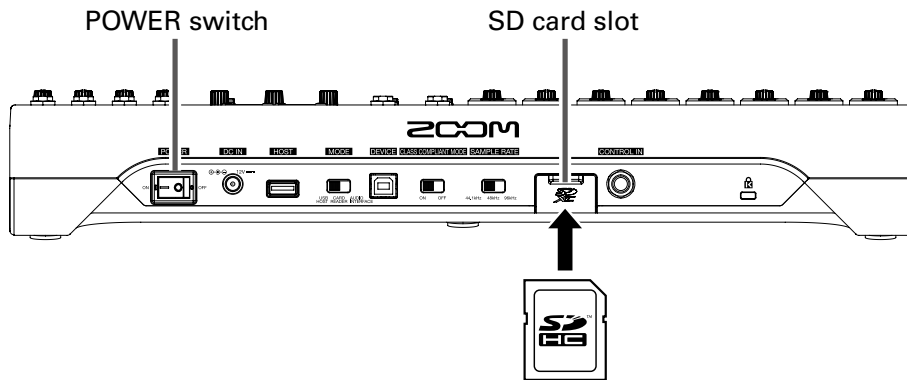

1. Set ON  OFF to OFF.

2. Open the SD card slot cover, and insert an SD card all the way into the slot.

To remove an SD card, push it further into the slot and then pull it out.



NOTE

- Disable write-protection on the SD card before inserting it.
- Always set ON  OFF to OFF before inserting or removing an SD card.
- Inserting or removing a card while the power is on could result in data loss.
- When inserting an SD card, be sure to insert the correct end with the top side up as shown.
- If an SD card is not loaded, recording and playback are not possible.
- To format an SD card, see [Formatting SD cards](#).

Creating new projects

The **L-12** manages recording and playback data in units called projects.

1. Select MENU > PROJECT > NEW PROJECT.

2. Use  to select YES, and press .



NOTE

- See [Projects](#) for information about projects.
- When a new project is created, it will start with the current mixer settings.

HINT

When the **L-12** power is turned on, it will automatically load the last used project.

Recording and playing tracks



The **L-12** has recorder functions that enable simultaneous recording of up to 14 tracks and simultaneous playback of up to 12 tracks.

The signals from every channel after they pass through their compressors and from the master fader output can be recorded. These recordings can also be played back.

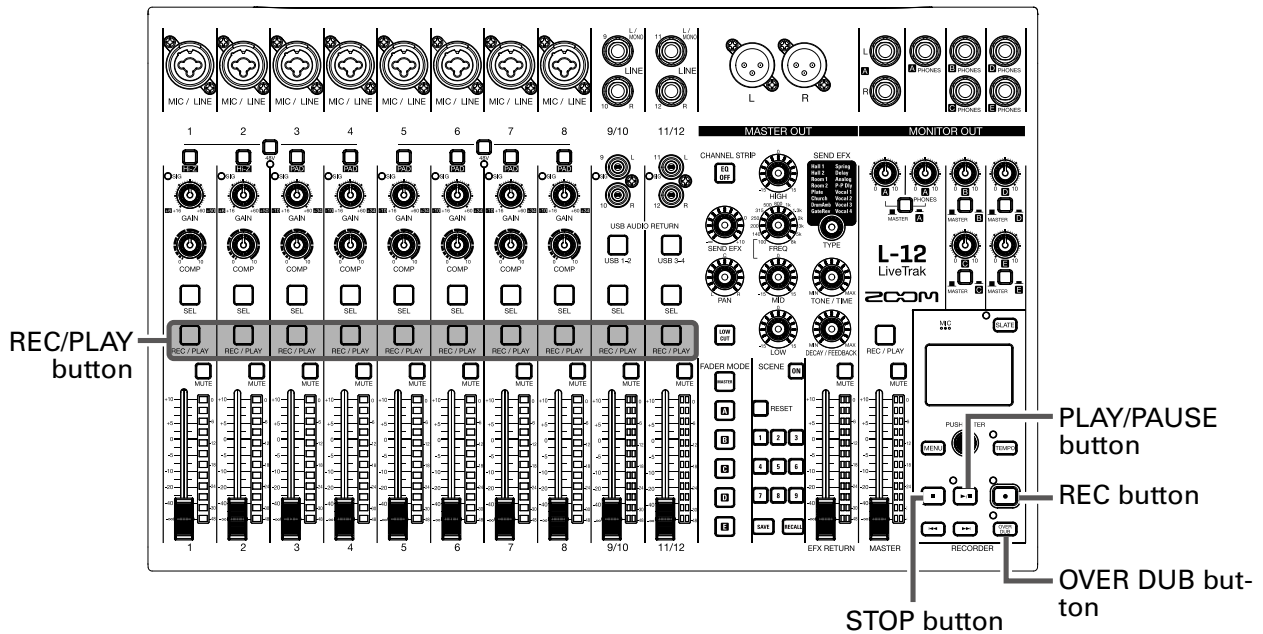
Recording





1. Use  to turn overdubbing on or off.

-  OVER DUB indicator
-  Lit (on): Overwrite current project
-  Unlit (off): Create and record to new project

2. Press  for the channels you want to record, lighting these buttons red.

3. Press  to start recording standby.

HINT

If a recorded file already exists, and  is off, pressing  will create a new project and then start recording standby.

4. Press  to start recording.

5. Press  to stop recording.

NOTE

- The signals for each channel are recorded after passing through their compressors. (→ [Mixer block diagram](#))
- Punching in/out (→ [Redoing parts of recordings \(punching in/out\)](#))
- Starting recording automatically (→ [Recording automatically](#))
- Capturing audio before recording starts (→ [Capturing audio before recording starts](#))
- When recording stops, “Please Wait” appears on the display. Do not turn the power off or remove the SD card while this message appears. Doing so could cause data loss or malfunction.

Playing recordings

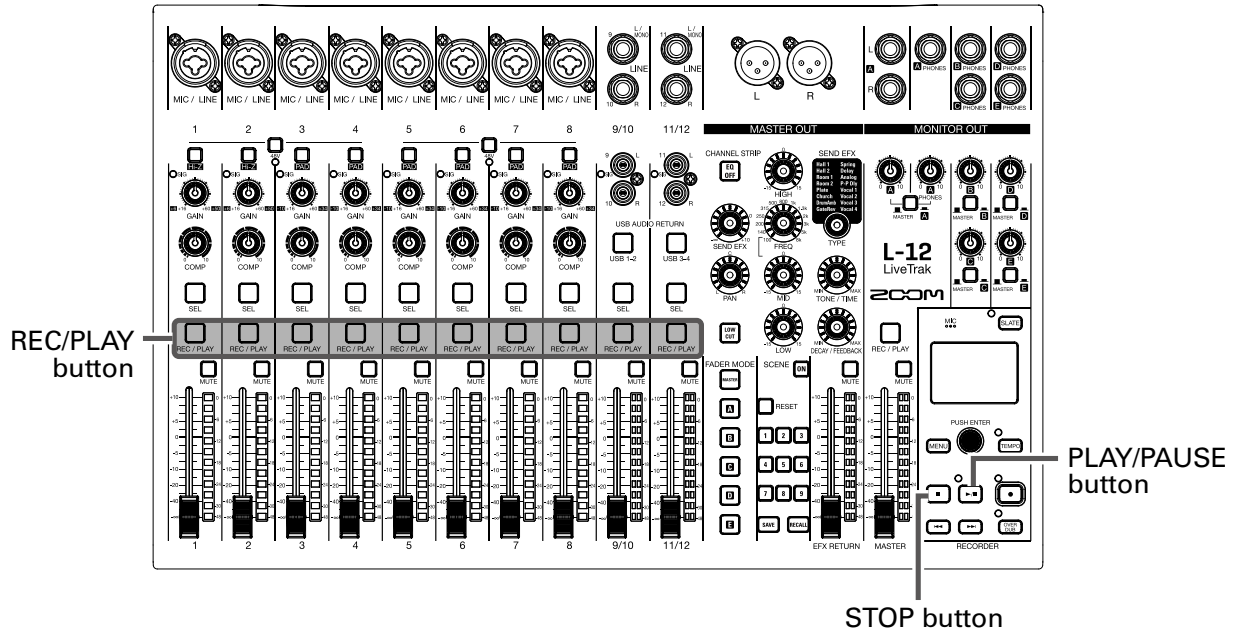

1. Press  for the channels you want to play, lighting these buttons green.

2. Press  to start playback.

 — PLAY/PAUSE indicator
 Lit: Playing back
 Blinking: Paused

3. Press  to stop playback.

NOTE

- Playback signals are added before the equalizer section, so their EQ and panning settings can be adjusted during playback. (→ [Mixer block diagram](#))
- Selecting projects for playback (→ [Selecting projects for playback](#))
- Changing the playback mode (→ [Changing the playback mode](#))
- Other channels cannot be played back when the MASTER channel is playing back.

Adding marks

Adding marks at desired positions with the recorder makes moving to those positions easy.

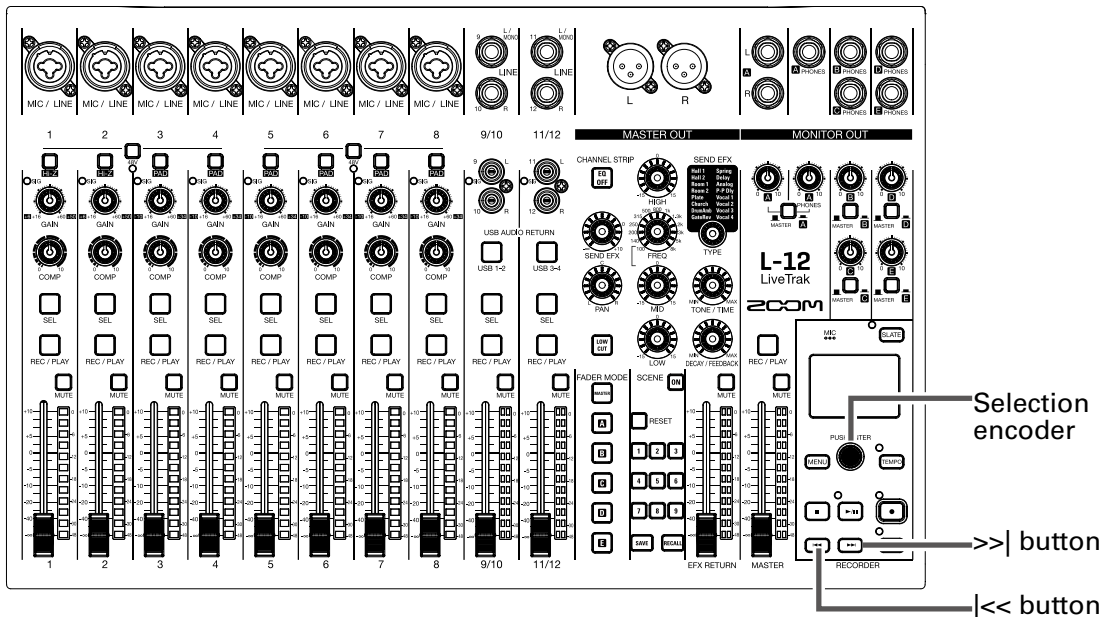

Adding marks during recording and playback

1. Press  during recording/playback.

Moving in mark order

1. Use these buttons to move in mark order.

Move to next mark: Press 

Move to previous mark: Press 

NOTE

Checking and deleting marks in projects (→ [Managing marks](#))

HINT

- A maximum of 99 marks can be added to one project.
- You can also delete a mark by pressing the  when at the mark position.

Redoing parts of recordings (punching in/out)

Punching in/out is a function that can be used to rerecord parts of already recorded tracks. "Punching in" is switching track status from playback to recording. "Punching out" is switching track status from recording to playback.

With **L-12** the , punching in/out can be conducted using buttons on its top or a footswitch (ZOOM FS01).

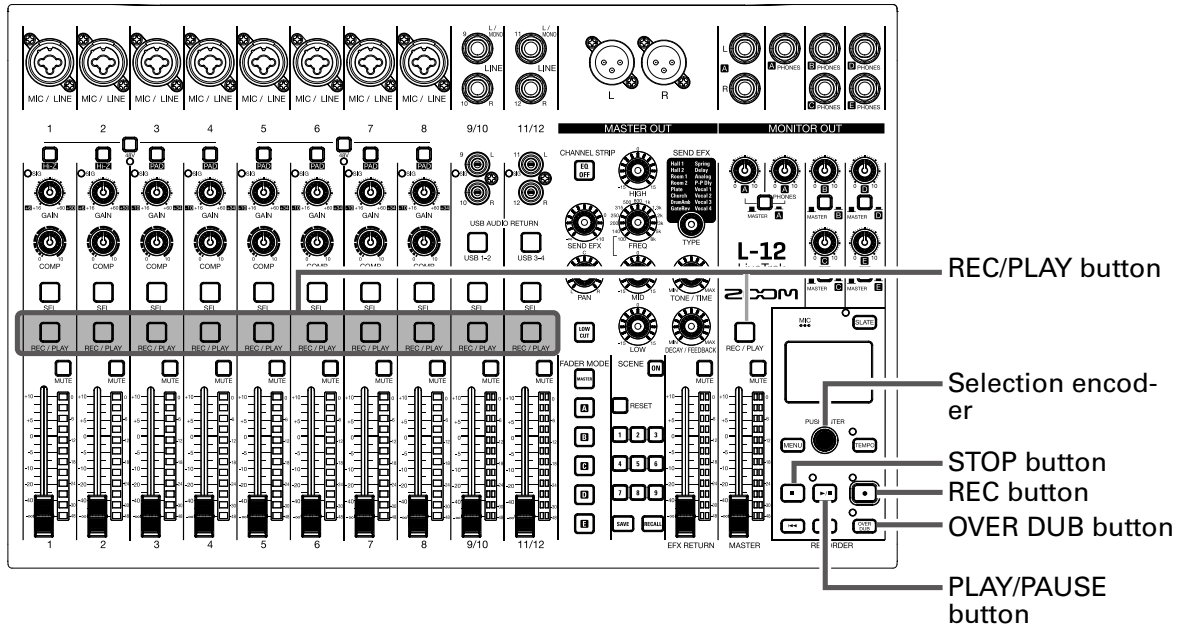

1. Press the to turn it on (lighting its indicator).

2. Press repeatedly for the tracks to re-record until they light red.



3. Press or turn left to move to before the part to be rerecorded.

4. Press to start playback.

5. Press at the position where you want to start rerecording (punch in).

6. Press to end rerecording (punch out).

NOTE

- Punching in/out using a footswitch (ZOOM FS01) (→ [Setting the footswitch](#))
- Punching in/out overwrites recordings.
- Punching in/out can be done up to 99 times each time playback is started.

7. Press to stop playback.

Mixing down tracks

A final stereo mix can be recorded to the master track.
Signals are sent to the master track after passing through the master fader.

Recording to the master track

1. Click  so that it lights.

NOTE

Adjust the volume and panning of each recorded track before starting.

2. Press MASTER  repeatedly until it lights red.



3. Press  to return to the recording beginning.

4. Press  to start recording standby.

5. Press  to start recording.

6. Press  to end mixing down.

Playing the master track

1. Press MASTER  repeatedly until it lights green.



2. Press .

NOTE



- To stop master track playback, press MASTER  repeatedly until it becomes unlit.
- When the master track is playing, other tracks will not be played back.
- To listen to master track playback from a MONITOR OUT, set the MONITOR OUT A–E switch to MASTER (■).

Recording automatically

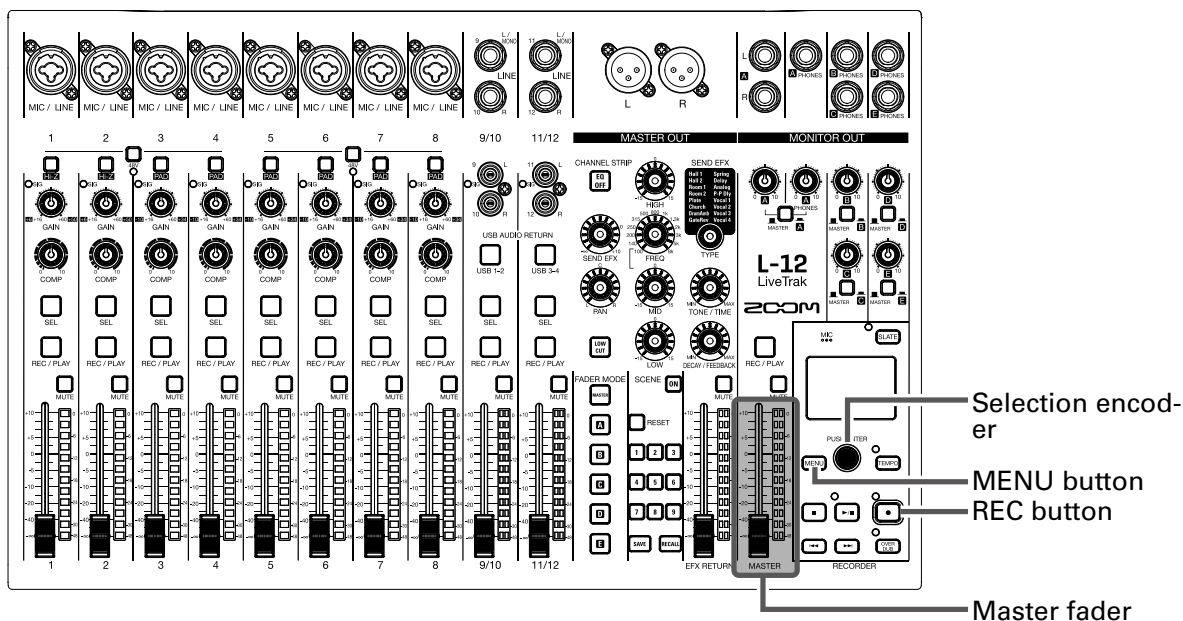
Recording can be started and stopped automatically in response to the level after passing through the master fader.



1. Select **MENU** > **REC/PLAY** > **AUTO REC** > **ON / OFF**.

2. Use  to select **ON**, and press .



NOTE

Making additional settings for automatic recording (→ [Changing automatic recording settings](#))

3. Press  repeatedly to return to the main recorder screen.

4. Press .

The indicator will light and recording standby will start.



The MASTER level meters will blink at the level that will cause automatic recording to start.

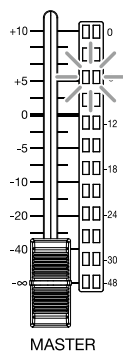

HINT

Recording starts automatically when the input exceeds the set level (shown by the MASTER level meters).

You can also set recording to stop automatically when the input goes below a set level. (→ [Setting automatic stopping](#))

5. Press  to end recording standby or stop recording.

NOTE

- This function cannot be used with the PRE REC, METRONOME or PRE COUNT functions. When you turn AUTO REC on, these other functions will be disabled.
- When you turn OVER DUB on, AUTO REC will be disabled.

Capturing audio before recording starts

The input signal can be captured for up to 2 seconds before recording is started (pre-recording). Setting this in advance can be useful when a performance starts suddenly, for example.

1. Select **MENU** > **REC/PLAY** > **PRE REC**.

2. Use  to select **ON**, and press .





NOTE

- This function cannot be used with the AUTO REC, METRONOME, PRE COUNT or OVER DUB functions.
- When you turn AUTO REC or PRE COUNT on, PRE REC will be disabled.
- The PRE REC function continues to be enabled even when recording is paused.

Selecting the folder where projects are saved

Choose one of ten folders as the folder where recorded projects will be saved.

1. Select MENU > FOLDER.

2. Use  to select the folder where you want to save, and press .

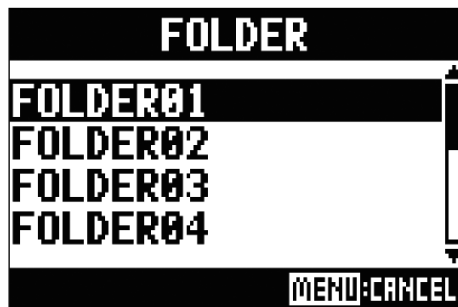



NOTE

- Up to 1000 projects can be saved in a single folder.
- If a folder that does not have a project is selected, a new project will be created automatically.

Selecting projects for playback

Projects saved on SD cards can be loaded.

1. Select **MENU** > **PROJECT** > **SELECT**.

2. Use  to select the project you want to load, and press .



NOTE

- Projects in different folders cannot be selected. To select a project that is saved in a different folder, select that folder first. (→ [Selecting the folder where projects are saved](#))
- When a project is loaded, the mixer settings saved in that project are also loaded.
- If actual channel fader positions differ from the channel fader positions of the loaded project, the level meters will show the recalled fader positions. The volume will not be changed until the actual fader position becomes the same as the recalled position.
- When switching to a different project, the project mixer settings of the current project are saved to the settings file in the project folder.

Using the metronome

The **L-12** metronome has adjustable volume, a selectable sound, and a precount function. The volume can also be adjusted separately for each output.

Metronome settings are saved separately with each project.

Enabling the metronome

1. Select **MENU** > **METRONOME** > **CLICK**.

2. Use  to select when the metronome makes sound, and press .



Setting value	Explanation
OFF	The metronome does not make sound.
REC AND PLAY	The metronome sounds during recording and playback.
REC ONLY	The metronome sounds only during recording.
PLAY ONLY	The metronome sounds only during playback.

Changing metronome settings

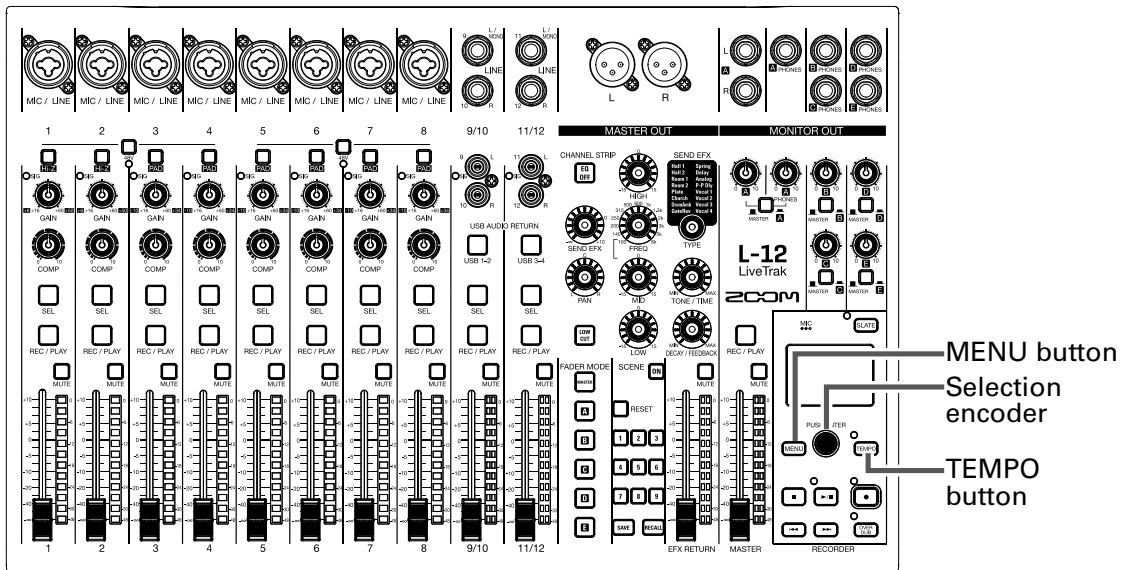

Changing the metronome tempo

1. Press **TEMPO**.

The current tempo is shown on the display.

2. Do one of the following to change the tempo.



- Turn 
- Press **TEMPO** repeatedly at the tempo you want to set



Setting the precount

A metronome count can be sounded before starting recording/playback.

1. Select MENU > METRONOME > PRE COUNT.

2. Use  to select the precount behavior, and press .

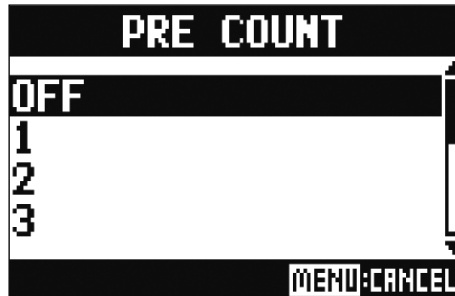

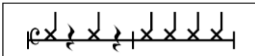

Setting value	Explanation
OFF	No precount will sound.
1-8	Before recording/playback, the precount will sound for the set number of times (1-8).
SPECIAL	Before recording/playback, the precount will sound as shown below. 

NOTE

- The precount is enabled even during playback.
- This function cannot be used with the AUTO REC function. When you turn AUTO REC on, PRE COUNT will be disabled.
- This function cannot be used with the PRE REC function. When you turn PRE COUNT on, PRE REC will be disabled.

Changing the metronome sound

1. Select **MENU** > **METRONOME** > **SOUND**.

2. Use  to select the sound, and press .



HINT



The options are BELL, CLICK, STICK, COWBELL and HI-O.

NOTE

Press  to play the metronome and check the sound.

Changing the metronome pattern

1. Select **MENU** > **METRONOME** > **PATTERN**.

2. Use  to select the pattern, and press .



HINT

The options are 1/4–8/4 and 6/8.



NOTE

Press  to play the metronome and check the pattern.

Changing the metronome volume

The metronome volume can be adjusted separately for the MASTER OUT and each of the MONITOR OUT A–E outputs.

1. Select **MENU** > **METRONOME** > **LEVEL** > **MASTER** or A-E.

2. Turn  to adjust the volume, and press .



HINT

Set from 0 to 100.

NOTE

Press  to play the metronome and check the volume.

Using the slate mic

The **L-12** has a built-in slate mic that allows comments to be recorded.

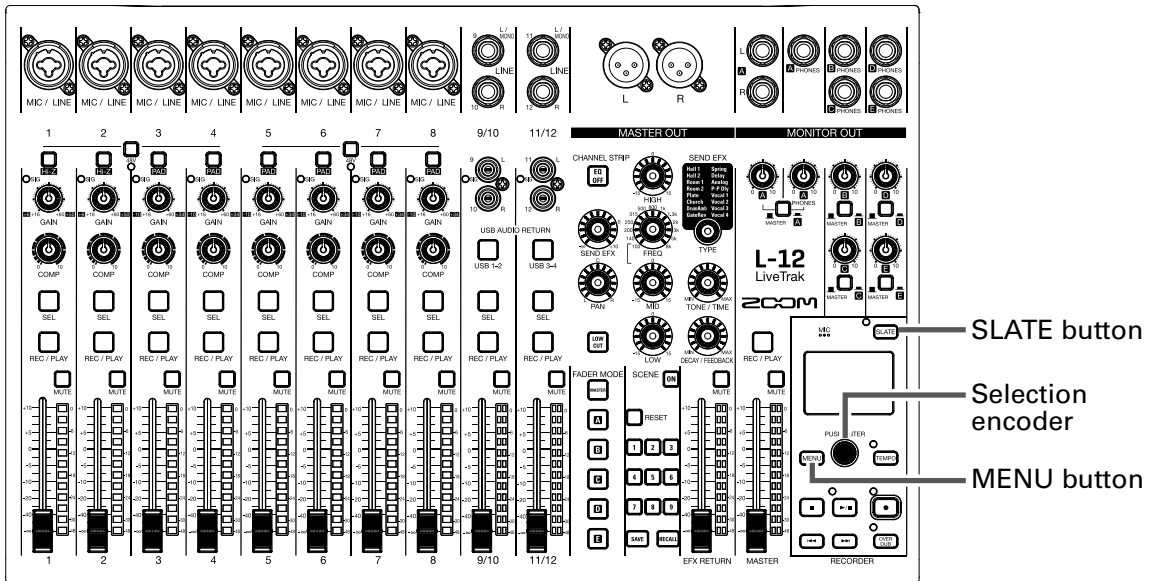

Recording with the slate mic

1. Start recording. (→ [Recording](#))

2. Press **SLATE** to enable the slate mic.

While **SLATE** is being pressed, the indicator lights and the slate mic is enabled.





NOTE

- When the slate mic is in use, signals from input jacks are muted to the channels to which the slate mic is routed.
- None of the channel faders affect the level of the slate mic.

Changing slate mic settings

Changing the slate mic volume

1. Select MENU > SLATE > LEVEL.

2. Turn  to adjust the volume, and press .



Changing the slate mic routing

1. Select MENU > SLATE > ROUTING.

2. Turn  to select a channel for routing.

3. Press  confirm.

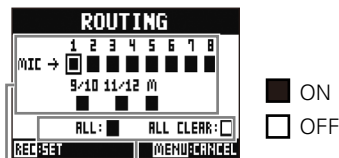

ALL: Set routing to all channels at once
ALL CLEAR: Clear all settings
Channel routing for slate mic input

4. Press .

HINT

Pressing  toggles it ON/OFF.

Projects

The **L-12** manages recording and playback data in units called projects.

The following data is saved in projects.

- Audio data
- Mixer settings
- Send return effect settings
- Mark information
- Metronome settings

Changing project names

The name of the currently loaded project can be changed.

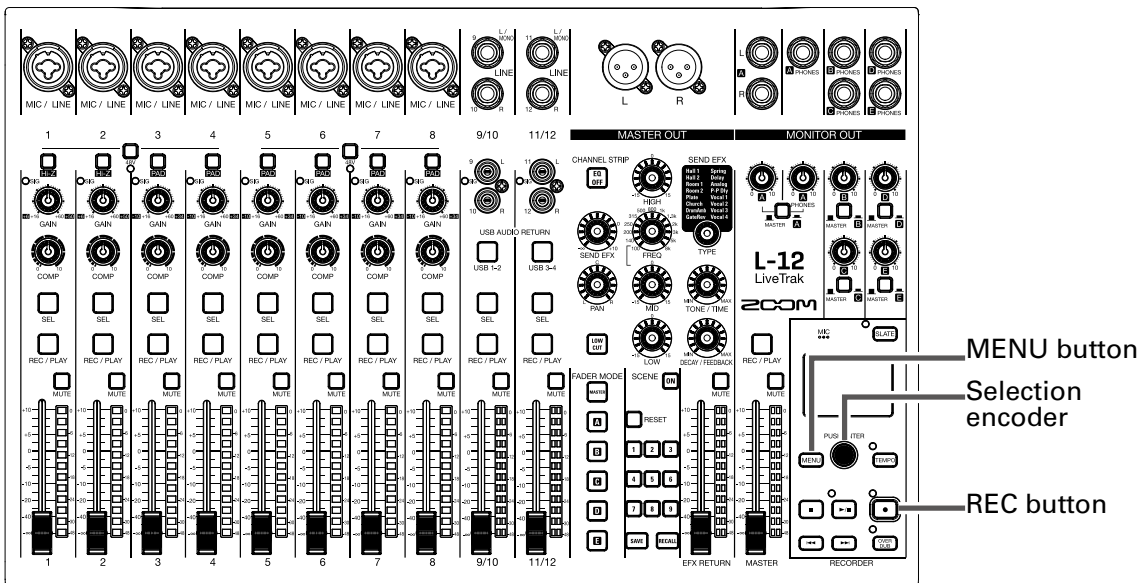

1. Select **MENU** > **PROJECT** > **RENAME**.

2. Edit the name.

Move cursor or change character: Turn 

Select character to change/confirm change: Press 

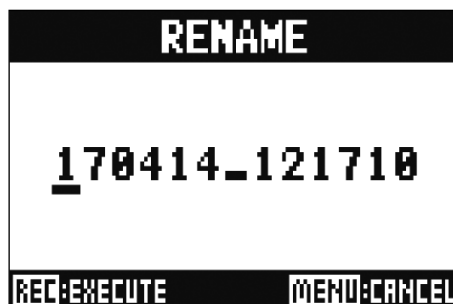

NOTE



- The default project name is the date and time of creation.
For example, if a project was created at 6:48:20 p.m. on March 14, 2017, the project name would be "170314_184820" (YYMMDD-HHMMSS).
- Project names have 13 characters.
- The following characters can be used in project and file names.
(space) ! # \$ % & ' () + , - 0 1 2 3 4 5 6 7 8 9 ; = @
A B C D E F G H I J K L M N O P Q R S T U V W X Y Z ^ _ `
a b c d e f g h i j k l m n o p q r s t u v w x y z { }`
- Projects can be ordered by numerical or alphabetical order.
- Project/file names cannot be only spaces.
- The project name is the same as the project folder name on the SD card.

3. Press .

Deleting projects

Projects inside the selected folder can be deleted.

1. Select **MENU** > **PROJECT** > **DELETE**

2. Use  to select the project you want to delete, and press .

3. Use  to select **YES**, and press .

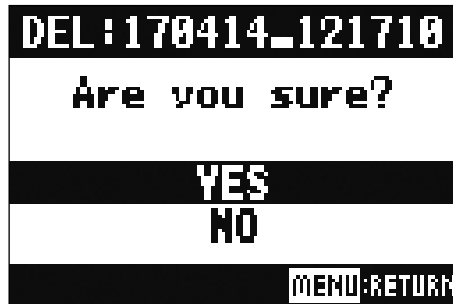

NOTE

Projects cannot be deleted if protection is ON.

Protecting projects

The currently loaded project can be write-protected, preventing the project from being saved, deleted or having its content changed.

1. Select MENU > PROJECT > PROJECT PROTECT.

2. Use  to select ON, and press .



NOTE

- Projects cannot be used for recording if protection is ON. Turn protection OFF to record.
- When protection is OFF for a project, it will always be saved to the SD card when the power is turned off or another project is loaded. We recommend turning protection ON to prevent accidentally saving changes to a musical project after it has been completed.

Checking project information

Various information about the currently loaded projects can be viewed.

1. Select **MENU** > **PROJECT**.

2. Use  to select **INFORMATION**, and press .



Items shown	Explanation
NAME	Project name
PATH	Location where project saved
DATE	Project creation date and time (YYYY/MM/DD HH:MM:SS)
FORMAT	Recording format
SIZE	Project size
TIME	Project length (HHH: MM: SS)
FILES	Information about tracks and files

Saving projects to USB flash drives

A USB flash drive can be connected directly to the **L-12**, and the currently loaded project can be saved to it.

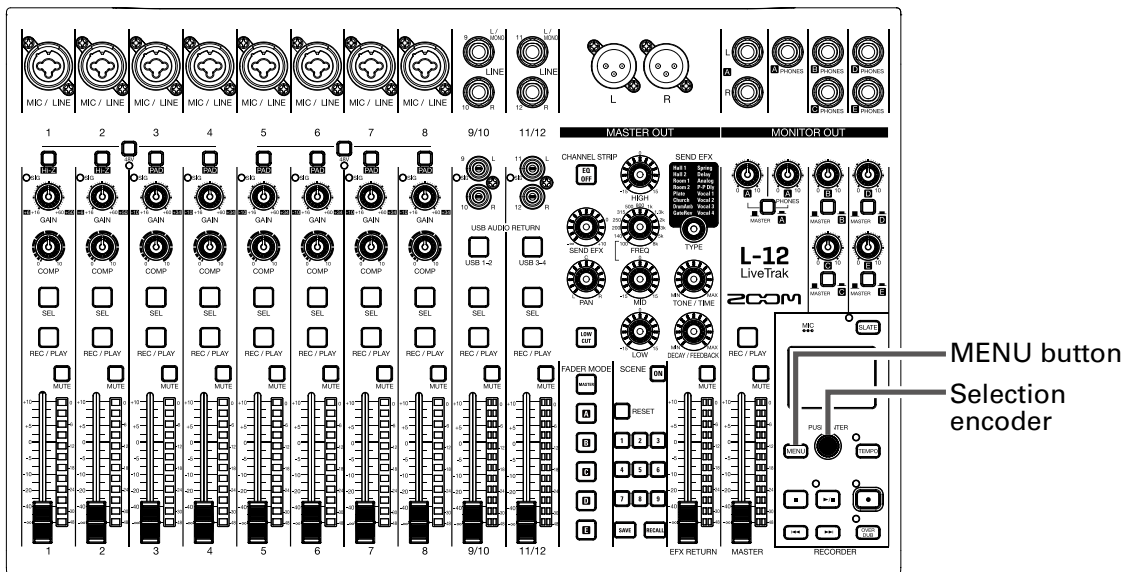
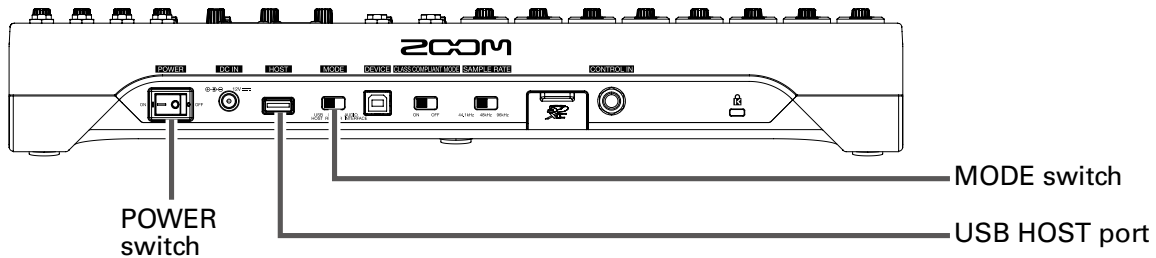

1. Set ON  OFF to OFF.

2. Connect the USB flash drive to the USB HOST port.



3. Set  to USB HOST.

4. Set ON  OFF to ON.

5. Select **MENU** > **PROJECT** > **PROJECT EXPORT**.

6. Edit the name.

Move cursor or change character: Turn 

Select character to change/confirm change: Press 

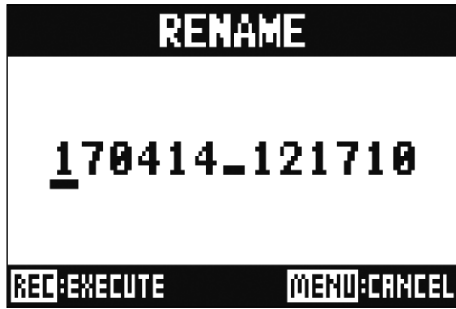

NOTE

- The default project name is the date and time of creation.
For example, if a project was created at 6:48:20 p.m. on March 14, 2017, the project name would be "170314_184820" (YYMMDD-HHMMSS).
- Project names have 13 characters.
- The following characters can be used in project and file names.
(space) ! # \$ % & ' () + , - 0 1 2 3 4 5 6 7 8 9 ; = @
A B C D E F G H I J K L M N O P Q R S T U V W X Y Z ^ _ `
a b c d e f g h i j k l m n o p q r s t u v w x y z { }`
- Projects can be ordered by numerical or alphabetical order.
- Project/file names cannot only be spaces.
- The project name is same as the project folder name on the SD card.

7. Press .

8. Use  to select YES, and press .



NOTE

- The folder structure on USB flash drives is as follows.
Never change this folder structure.



- Projects will be saved on the USB flash drive in the "PROJECT" subfolder of the "ZOOM_L-12" folder.
- Never disconnect a USB flash drive when "Saving" or "Loading" appears on the display.

Importing projects from USB flash drives

Projects saved on USB flash drives can be copied to SD cards.

NOTE

Use a computer to create "ZOOM_L12" and "PROJECT" folders on the USB flash drive in advance (→ [Saving projects to USB flash drives](#)). Only projects inside the "PROJECT" folder can be imported.

1. Set  OFF to OFF.



2. Connect the USB flash drive to the USB HOST port.



3. Set  to USB HOST.

4. Set  OFF to ON.

5. Select **MENU** > **PROJECT** > **PROJECT IMPORT**.

6. Use  to select the project you want to load from the USB flash drive, and press .



7. Edit the name.

Move cursor or change character: Turn 

Select character to change/confirm change: Press 



NOTE

- The default project name is the date and time of creation.
For example, if a project was created at 6:48:20 p.m. on March 14, 2017, the project name would be "170314_184820" (YYMMDD-HHMMSS).
- Project names have 13 characters.
- The following characters can be used in project and file names.
(space) ! # \$ % & ' () + , - 0 1 2 3 4 5 6 7 8 9 ; = @
A B C D E F G H I J K L M N O P Q R S T U V W X Y Z ^ _ `
a b c d e f g h i j k l m n o p q r s t u v w x y z { }`
- Projects can be ordered by numerical or alphabetical order.
- Project/file names cannot only be spaces.
- The project name is the same as the project folder name on the SD card.

8. Press .

9. Use  to select YES, and press .



NOTE

- Imported projects are saved in the currently selected folder.
- Never disconnect a USB flash drive when "Saving" or "Loading" appears on the display.

Managing marks

A list of marks in the currently loaded project can be opened, allowing them to be checked, played and deleted.

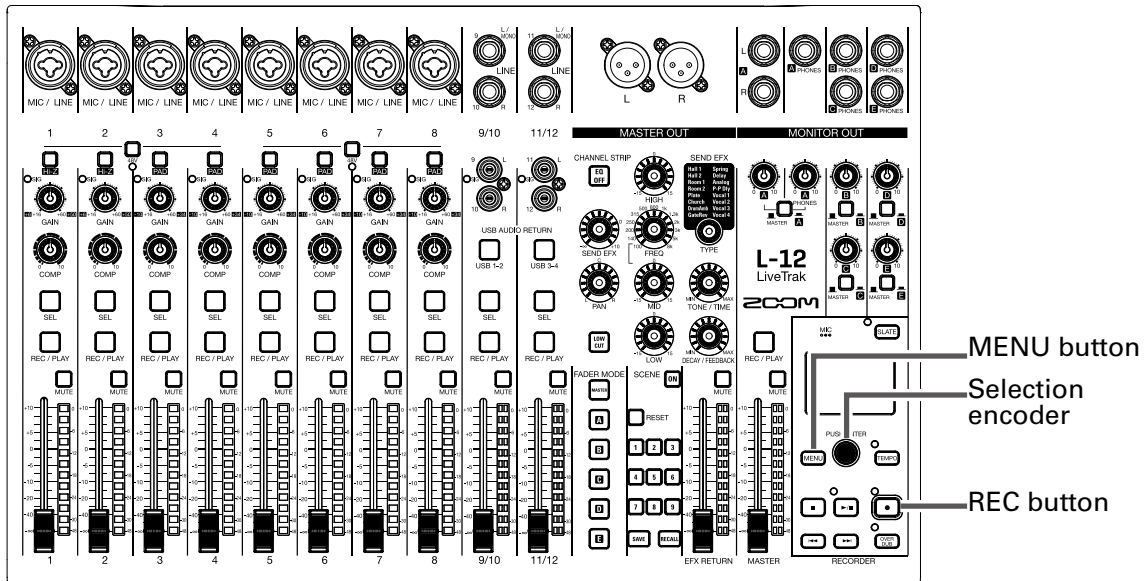

1. Select **MENU** > **PROJECT** > **MARK LIST**.

A list of marks appears.

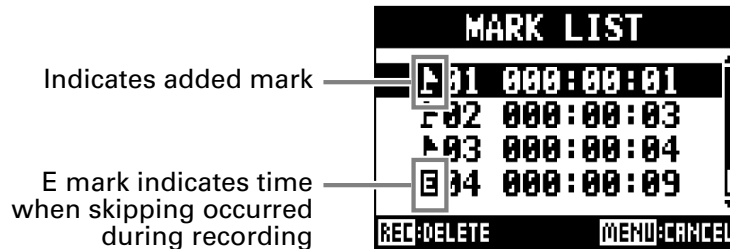

2. Use  to select a mark, and play or delete it.

Press  to move to the mark position.

Press  to delete the mark.

Audio files

The **L-12** creates the following types of audio files according to the recording channel.

- Channels 1–8: mono WAV files
- Channels 9/10, 11/12 and MASTER: stereo WAV files

The file format depends on the sampling rate (→ [Changing the sampling rate](#)) and quantization bit depth (→ [Changing the recording format](#)) used by the unit.

The **L-12** can also play back audio files created using DAW software (→ [Importing audio files from USB flash drives](#)).

NOTE



- The names given to audio files depend on their channels.
Channels 1–8: TRACK01–TRACK08
Channels 9/10, 11/12: TRACK09_10, TRACK11_12
MASTER: MASTER
- If the file size exceeds 2GB during recording, a new file will be created automatically in the same project and recording will continue without pause. When this happens, numbers will be added to the ends of the file names: “-01”, “-02” and so on.

Deleting audio files

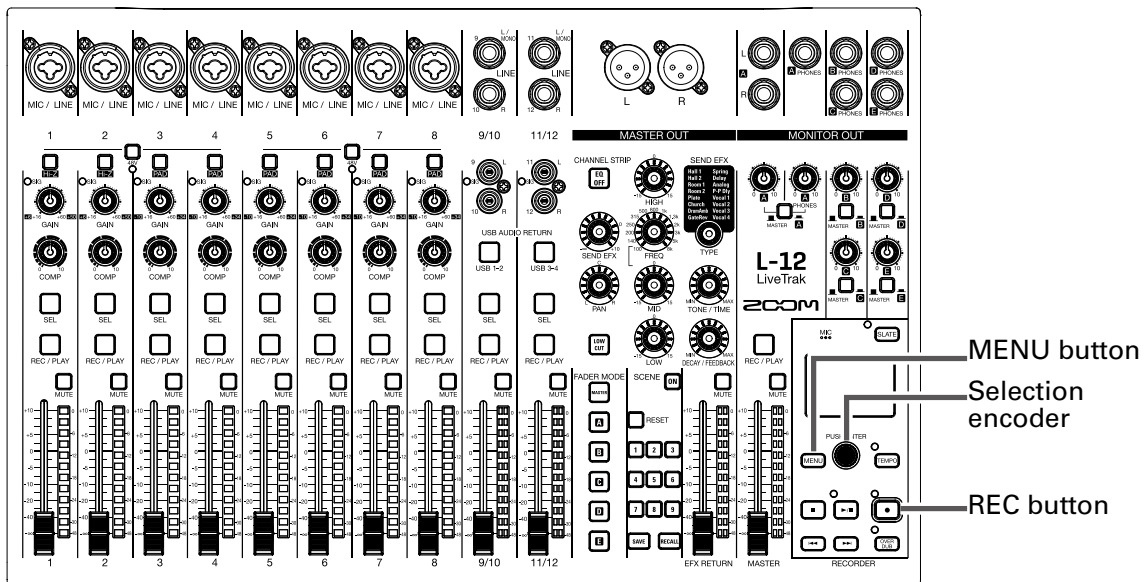
Audio files that are not needed can be deleted.





1. Select **MENU** > **PROJECT** > **FILE DELETE**.



2. Use  to select the file you want to delete, and press .



NOTE

Press  to select/deselect all files.

3. Press .

4. Use  to select YES, and press .



NOTE

Audio files cannot be deleted if protection is ON for their projects.

Exporting audio files to USB flash drives

The desired audio files can be exported from projects to USB flash drives.

Exported audio files will be saved on the USB flash drive in the "AUDIO" subfolder of the "ZOOM_L-12" folder.

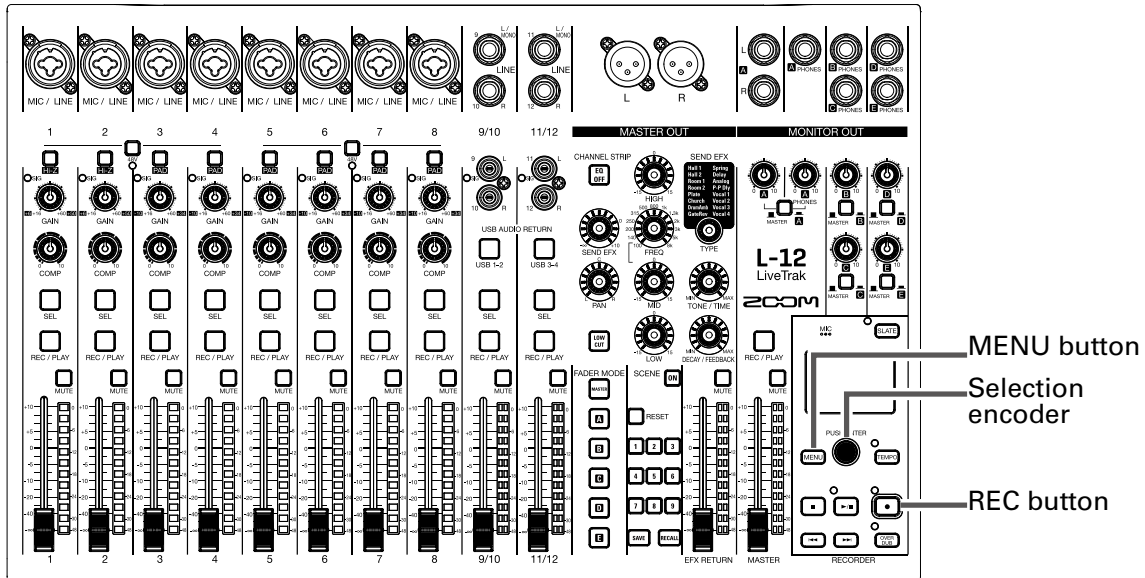

1. Set ON  OFF to OFF.

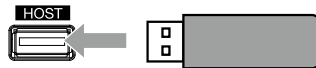

2. Connect the USB flash drive to the USB HOST port.



3. Set  to USB HOST.

4. Set ON  OFF to ON.

5. Select **MENU** > **PROJECT** > **FILE EXPORT**.

6. Use  to select the file you want to export, and press .



7. Edit the name.

Move cursor or change character: Turn 

Select character to change/confirm change: Press 



NOTE

- Audio file names have 24 characters.
- The following characters can be used in project and file names.
(space) ! # \$ % & ' () + , - 0 1 2 3 4 5 6 7 8 9 ; = @
A B C D E F G H I J K L M N O P Q R S T U V W X Y Z ^ _ `
a b c d e f g h i j k l m n o p q r s t u v w x y z { }
- Project/file names cannot only be spaces.

8. Press .

9. Use  to select YES, and press .



NOTE

- Never disconnect a USB flash drive when "Saving" or "Loading" appears on the display.
- Audio files will be saved on the USB flash drive in the "AUDIO" subfolder of the "ZOOM_L-12" folder.

Importing audio files from USB flash drives

The desired audio files can be imported from USB flash drives to existing projects and assigned to channels.

NOTE

Use a computer to create "ZOOM_L-12" and "AUDIO" folders on the USB flash drive in advance (→ [Saving projects to USB flash drives](#)). Only audio files inside the "AUDIO" folder can be imported.

1. Set ON  OFF to OFF.



2. Connect the USB flash drive to the USB HOST port.



3. Set  to USB HOST.

4. Set ON  OFF to ON.



5. Select MENU > PROJECT > FILE IMPORT.

6. Use  to select the file you want to import, and press .



NOTE

Audio files cannot be imported from USB flash drives into projects that have protection ON.

7. Use  to select the channel where you want to assign the file, and press .



NOTE

- Mono WAV files can be assigned to mono channels and stereo WAV files can be assigned to stereo channels.
- Files cannot be imported to channels that already have files assigned to them.
- When files are imported, their file names will automatically be changed according to their import channels.

8. Use  to select YES, and press .

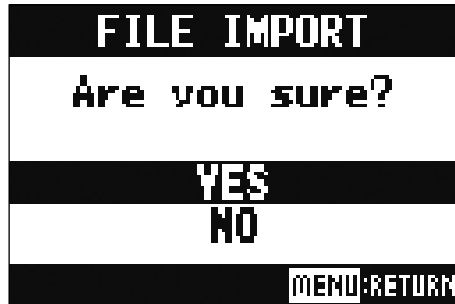
**NOTE**

Never disconnect a USB flash drive when "Saving" or "Loading" appears on the display.

Using audio interface functions

The **L-12** can be used as a 14-in/4-out USB audio interface. After applying its compressor, each input channel always outputs its signal to the corresponding USB audio channel. Channels 1–12 and the stereo signal output from the master fader are sent to the computer (14 channels total).

Installing the driver

1. Download the "ZOOM L-12 Driver" from <http://www.zoom.co.jp> to the computer.

NOTE

- You can download the latest "ZOOM L-12 Driver" from the above website.
- Download the driver for the operating system that you are using.

-
2. Launch the installer and install the driver.

Follow the instructions that appear on screen to install the ZOOM L-12 Driver.

NOTE

See the Installation Guide included in the driver package for detailed installation procedures.

Connecting to a computer

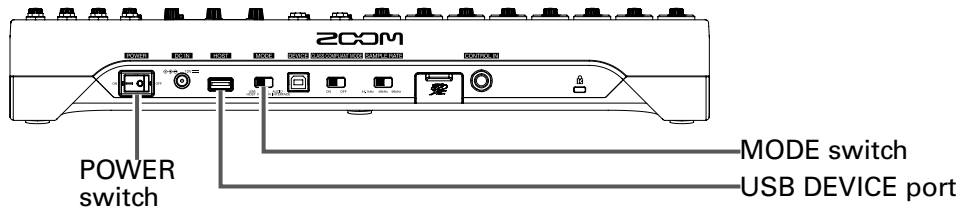

1. Use a USB cable to connect the USB DEVICE port to the computer.

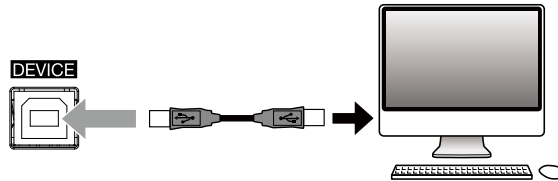

2. Set the  switch to AUDIO INTERFACE.

3. Set ON  OFF to ON.

NOTE

- Set  to ON when connected to an iOS device.
- When connecting to an iOS device, use a Lightning to USB camera adapter (or Lightning to USB 3 camera adapter).

4. Set the **L-12** as the computer sound device.

NOTE

- Audio interface functions cannot be used when the sampling rate is set to 96 kHz.

Inputting return signals from the computer to a stereo channel

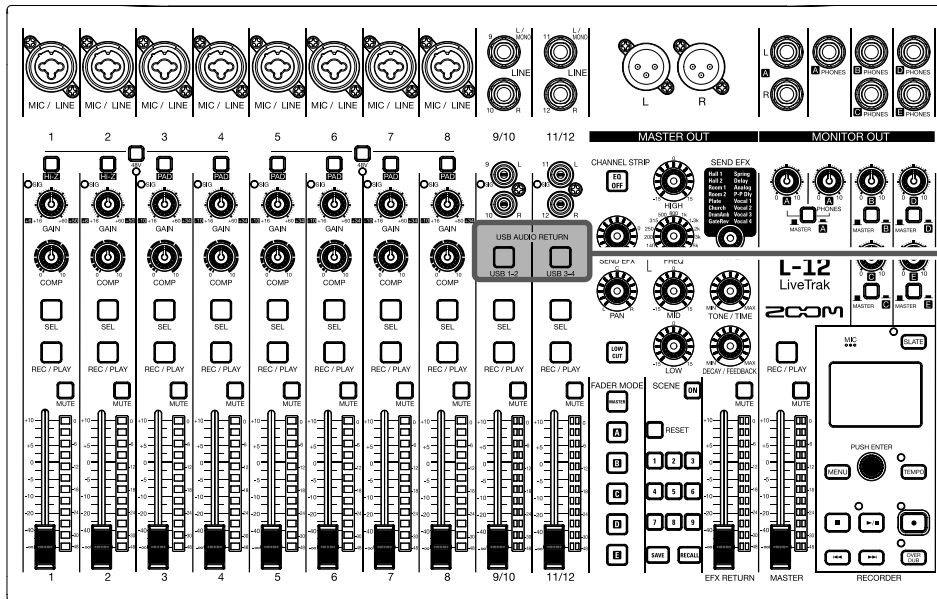

1. Turn the button channel ON for the stereo channel to use for input.

The signal controlled by the channel is switched to the USB audio channel signal (before EQ).

Using card reader functions

When connected to a computer, data on the SD card can be checked and copied.

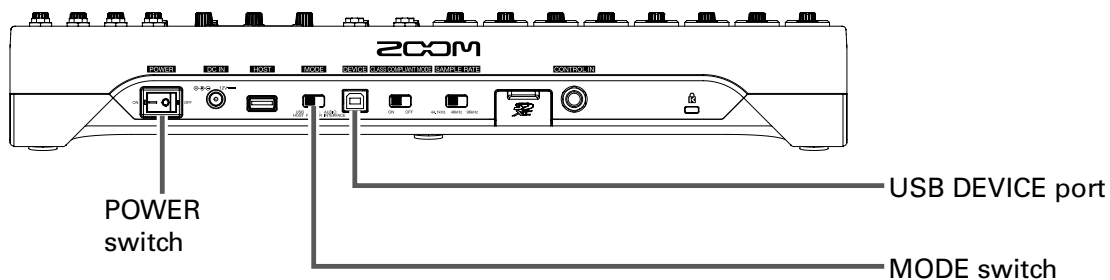

1. Use a USB cable to connect the USB DEVICE port to the computer.

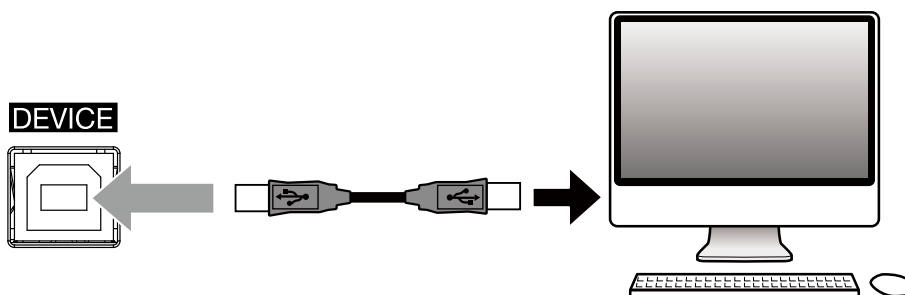

2. Set  to CARD READER.

3. Set  ON/OFF to ON.

NOTE



When operating as a CARD READER, other functions and buttons cannot be used.

Recording and playback settings

Changing the recording format

The recording format can be changed in consideration of audio quality and file size.

1. Open **MENU** > **REC / PLAY** > **REC FORMAT**.

2. Use  to change the format, and press .



HINT



When overwriting a recording, recording will occur at the bit depth of the original file. For example, a file recorded at 16-bit cannot be overwritten with 24-bit recording.

Changing automatic recording settings

The conditions for automatically starting and stopping recording can be set.

Setting the automatic recording start level

1. Open MENU > REC / PLAY > AUTO REC > REC START LEVEL.

2. Use  to change the start level, and press .





Recording will start automatically when the level of the MASTER fader output signal exceeds the set level.

HINT

This can be set from -48 to 0 dB.

Setting automatic stopping

1. Open MENU > REC / PLAY > AUTO REC > AUTO STOP.



2. Use  to select the automatic stop time, and press .



HINT

This can be set to OFF or between 0 and 5 seconds.

3. Open MENU > REC / PLAY > AUTO REC > REC STOP LEVEL.

4. Use  to set the stop level, and press .



Recording will stop automatically when the level of the MASTER fader output stays below the set level for the amount of time set in step 2.



NOTE

If you start recording after setting automatic recording starting and stopping, the level set in step 4 will be shown on the MASTER level meters.

Showing recording levels on level meters

The signals of levels recorded to the recorder or recorded to a computer when using the audio interface function can be shown on the level meters of each channel.

1. Open MENU > REC / PLAY > REC LEVEL METER.

2. Use  to select ON, and press .

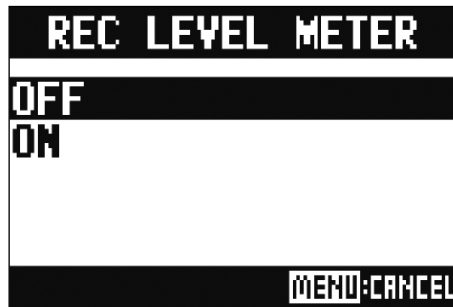



If recorded signal levels are higher than post fader levels, the recorded signal levels are shown lit dimly on the level meters.

Enabling latency adjustment

When overdubbing, adjustment can be made for the delay caused by analog-to-digital conversion, signal processing and digital-to-analog conversion.

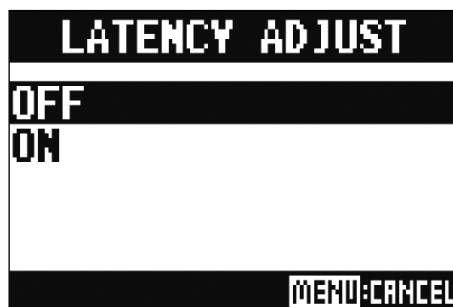

1. Open MENU > REC / PLAY > LATENCY ADJUST.

2. Use  to select ON, and press .







Changing the playback mode

1. Open MENU > REC / PLAY > PLAY MODE.

2. Use  to select the play mode, and press .



Setting value	Explanation
OFF	Only the selected project plays back. Playback continues even when the end of a file is reached.
PLAY ONE  (single song playback)	Only the selected project plays back. Playback stops when when the end of a file is reached.
PLAY ALL  (all song playback)	Every project from the selected one to the last one will be played back.
REPEAT ONE  (single song repeat playback)	The selected project will be played repeatedly.
REPEAT ALL  (all song repeat playback)	All projects in the selected folder will be played repeatedly.

SD card settings

Checking the open space on SD cards

1. Open MENU > SD CARD > REMAIN.

This shows the open space on the card.

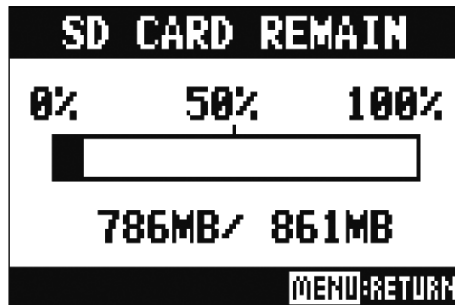

NOTE

The **L-12** shows less than the actual open space in order to maintain space to prevent SD card writing performance from degrading.

Formatting SD cards

Format SD cards for use with the **L-12**.

1. Open MENU > SD CARD > FORMAT.

2. Use  to select YES, and press .



NOTE

- Before using SD cards that have just been purchased or that have been formatted on a computer, they must be formatted by the **L-12**.
- Be aware that all data previously saved on the SD card will be deleted when it is formatted.
- Format an SD card before recording to it at 96 kHz.



Testing SD card performance

You can test whether SD cards can be used with the **L-12**.

A basic test can be done quickly, while a full test examines the entire SD card.

Conducting a quick test

1. Open **MENU** > **SD CARD** > **PERFORMANCE TEST**.

2. Use  to select **QUICK**, and press .

3. Use  to select **YES**, and press .

The card performance test will start. The test should take about 30 seconds.

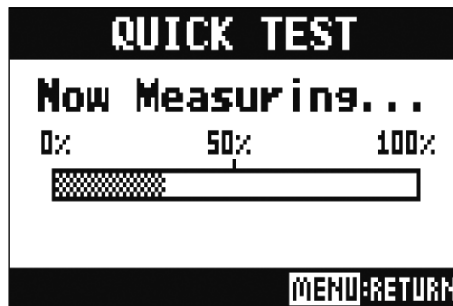

The result of the test will be shown when it completes.

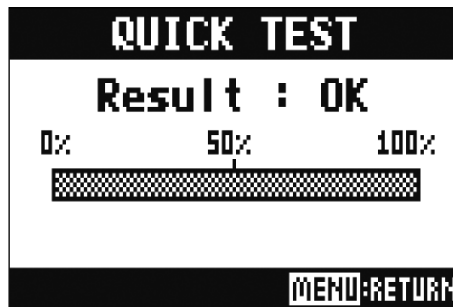

4. Press  to stop the test.

NOTE

Even if a performance test result is "OK", there is no guarantee that writing errors will not occur. This information is just to provide guidance.

Conducting a full test

1. Open MENU > SD CARD > PERFORMANCE TEST.

2. Use  to select FULL TEST, and press .

The amount of time required will be shown.

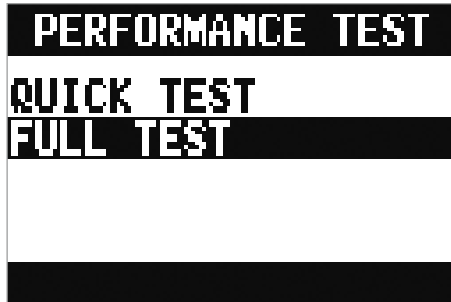

3. Use  to select YES, and press .

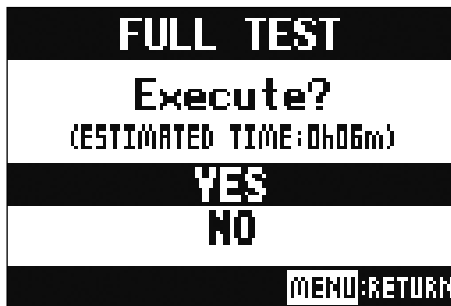

The result of the test will be shown when it completes.

If the access rate MAX reaches 100%, the card will fail (NG).



4. Press  to stop the test.

HINT

You can press  to pause and resume a test.

NOTE

Even if a performance test result is "OK", there is no guarantee that writing errors will not occur. This information is just to provide guidance.

Various settings

Setting the date and time

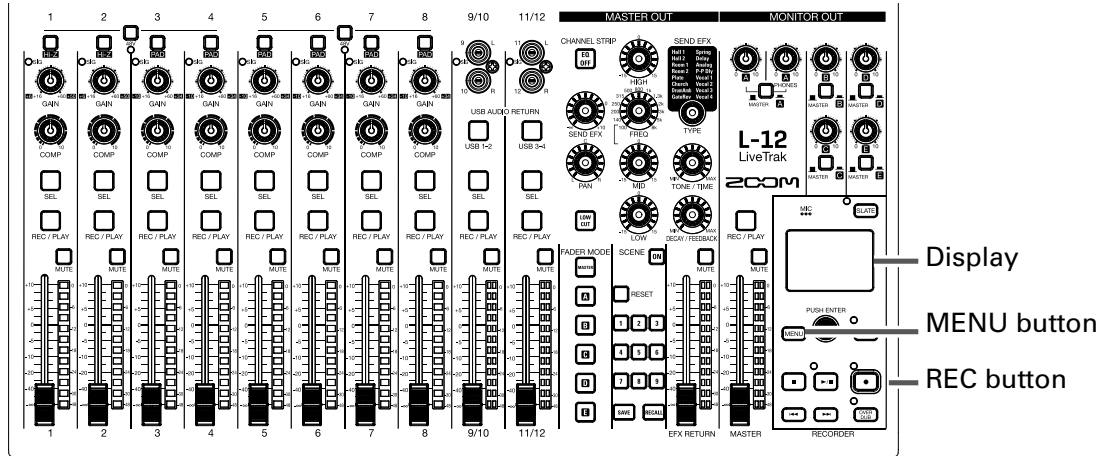

1. Select **MENU** > **SYSTEM** > **DATE/TIME**.

2. Set the date and time.

Move cursor or change value: Turn 

Select item/confirm change: Press 

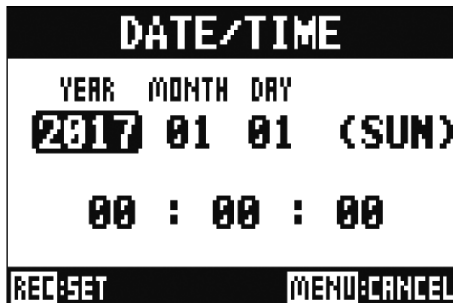

3. Press .

The first time you turn the power on after purchase, you must set the date/ time.



Setting the footswitch

If a footswitch (ZOOM FS01) is connected to the CONTROL IN jack, you can start/stop recorder playback punch in/out or mute/unmute the send effect by foot.

1. Open MENU > SYSTEM > CONTROL IN.

2. Use  to change the value.



Setting value	Explanation
PLAY	Press the footswitch to start/stop playback (equivalent to )
PUNCH I/O	Use to control punching in/out (equivalent to )
SEND EFX MUTE	Mute/unmute the send effect

Changing the sampling rate

The file format used when recording to the recorder depends on this setting.

Before changing the sampling rate, **L-12** must be set to OFF.

1. Confirm that  is set to off.

2. Change the  position.

HINT

The options are 44.1 kHz, 48 kHz and 96 kHz.

NOTE

- When 96 kHz is selected, some unit operations are limited. The limited functions are as follows.
 - Recordable tracks: tracks 1–12 only
 - SEND EFX: disabled
 - EQ: disabled
 - OVER DUB: disabled
 - Audio interface: disabled
 - MONITOR OUT: output signal same as MASTER only
- Format an SD card before recording to it at 96 kHz.

3. Set  to ON.



NOTE

- The sampling rate cannot be changed during operation.
- If a project is loaded that has a different sampling rate than the unit setting, recording and playback will not be possible.

Disabling the automatic power saving function

The power will automatically turn off if the **L-12** is unused for 10 hours.

If you want the power to stay on always, disable the automatic power saving function

1. While pressing and holding , set ON  OFF to ON.

2. Use  to select OFF, and press .

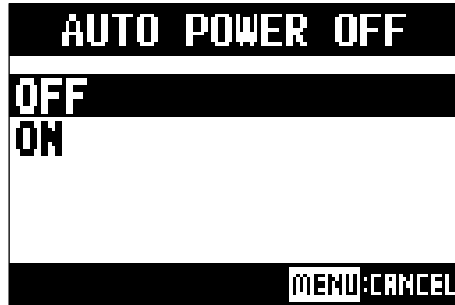

NOTE

This setting is saved in the unit.

Adjusting the display contrast

1. Open MENU > SYSTEM > DISPLAY CONTRAST.

2. Use  to select YES, and press .

HINT

This can be set from 1 to 10.

Restoring settings to factory defaults

You can restore an **L-12** to its factory default settings.

1. Open **MENU** > **SYSTEM** > **FACTORY RESET**.

2. Use  to select **YES**, and press .

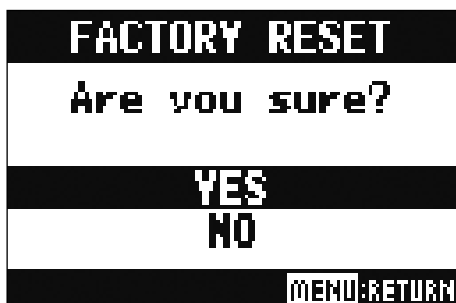

NOTE

This does not reset mixer settings. (→ [Resetting mixer settings](#))

Checking the firmware versions

The **L-12** firmware versions can be viewed.

1. Open **MENU** > **SYSTEM** > **FIRMWARE VERSION**.

This shows the firmware versions.

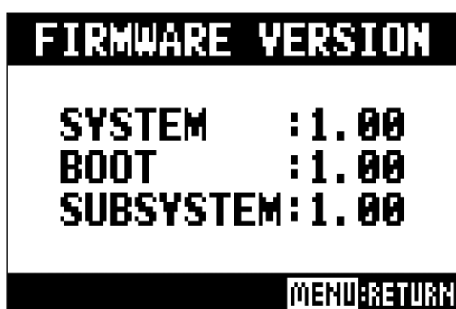

Updating the firmware



The **L-12** firmware can be updated to the latest versions.

1. Copy the file for updating the firmware to the root directory on an SD card.

NOTE

An update file for the latest version can be downloaded from the ZOOM website (www.zoom.co.jp).

2. Insert the SD card into the **L-12**.

3. While pressing and holding , set  OFF to ON.

4. press .



NOTE

Do not turn the power off or remove the SD card during a firmware update. Doing so could cause the **L-12** to become unstartable.

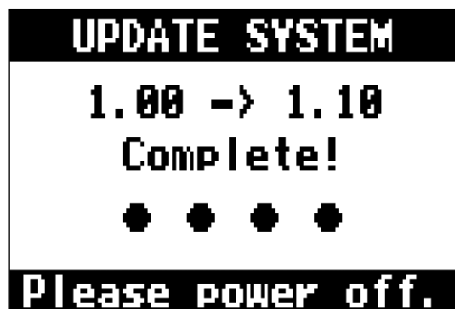

5. After the firmware update completes, turn the  OFF off.





Troubleshooting

General

There is no sound or output is very quiet

- Check the speaker connections and volume settings on the speakers.
- Check instrument and mic connections
- When using a condenser mic, turn  on.
- Confirm that the SIG indicators are lit green.
- Confirm that  is unlit.
- Raise all the channel faders and the master fader, and confirm that the level meters are lit.
- Confirm that the MASTER  is unlit or is lit red.

Recorded audio is too loud, too quiet or silent

- Adjust input gains and confirm that SIG indicators are lit green.
- When using a condenser mic, turn  on.
- When recording to an SD card, confirm that  is lit red.

Recording not possible

- When recording to an SD card, confirm that  is lit red.
- Confirm that the SD card has open space.
- When recording to an SD card, confirm that the project is not protected (to prevent overwriting).

Playback sound cannot be heard or is quiet

- When playing data from an SD card, confirm that  is lit green.
- Raise the faders on the playback channels, and confirm that the level meters are lit.

The sounds of devices connected to input jacks are distorted

- Confirm that SIG indicators are not lighting red. If they are lighting, lower their input gains. You can also turn  on.
- Confirm that level meters are not lighting to their highest levels. If a level meter is lighting to its highest level, lower its fader.

The send effect is not working

- Confirm that the EFX RETURN  is unlit.
- Raise the EFX RETURN fader, and confirm that the EFX RETURN level meters are lit.
- Confirm the send amounts of the channels on which you want to use the effect.

There is no sound or output is very quiet from MONITOR OUT A-E

- Confirm the mixes of each output.
- Confirm that the output volume of each output is raised (MONITOR OUT A PHONES and MONITOR OUT A-E knobs).
- Confirm the settings of the MONITOR OUT A-E switches.

Audio interface



Cannot select or use the L-12 device

- Confirm that  the **L-12** is connected to the computer correctly.
- Confirm that is set to OFF on the **L-12**.
- Quit all the software that is using the **L-12**, and turn the off and on again.
- Reinstall the driver.
- Connect the **L-12** directly to a USB port on the computer. Do not connect it through a USB hub.

Sound skips during playback or recording

- If you can adjust the audio buffer size of the software that you are using, increase the buffer size.
- Connect the **L-12** directly to a USB port on the computer. Do not connect it through a USB hub.
- Turn the automatic sleep function and other computer power saving settings off.

Cannot play or record

- Confirm that the **L-12** is connected to the computer correctly.
- Confirm that the Sound setting of the computer you are using is set to "ZOOM L-12".
- Confirm that **L-12** is set for input and output in the software that you are using.
- Confirm that the   is lit red and the level meters are lit for channels 9/10 or 11/12.
- Quit all the software that is using the **L-12**, and disconnect and reconnect the USB cable connected to the **L-12**.

Specifications

Number of input and output channels	Inputs	Mono (MIC/LINE)	8	
		Stereo (LINE)	2	
	Outputs	MASTER OUT	1	
		MONITOR OUT	5	
Inputs	Mono (MIC/LINE)	Type	XLR/TRS combo jacks (XLR: 2 HOT, TRS: TIP HOT)	
		Input gain	PAD OFF: +16 – +60 dB PAD ON: –10 – +34 dB Hi-Z ON: +6 – +50 dB	
		Input impedance	XLR: 3 k Ω TRS: 10 k Ω /1 M Ω (when Hi-Z ON)	
		Maximum input level	PAD OFF: 0 dBu (at 0 dBFS) PAD ON: +26 dBu (at 0 dBFS)	
		Phantom power	+48 V	
	Stereo (LINE)	Type	TS phone/RCA pin (unbalanced) jacks	
		Maximum input level	+10 dBu	
	Outputs	MASTER OUT	Type	XLR jacks (balanced)
			Maximum output level	+14.5 dBu
			Output impedance	100 Ω
MONITOR OUT A (TRS)		Type	TRS phone jacks (balanced)	
		Maximum output level	+14.5 dBu	
		Output impedance	100 Ω	
MONITOR OUT A–E (PHONES)		Type	Standard stereo phone jacks	
		Maximum output level	42 mW + 42 mW @60 ohm	
		Output impedance	100 Ω	
Buses	MASTER	1		
	MONITOR	5		
	SEND EFX	1		
Channel strip	COMP			
	LOW CUT	75 Hz, 12 dB/OCT		
	EQ	HIGH: 10 kHz, \pm 15 dB, shelving MID: 100 Hz–8 kHz, \pm 15 dB, peaking LOW: 100 Hz, \pm 15 dB, shelving		
Level meters		12 segments		
Send effects		16 types		
Recorder	Maximum simultaneous recording tracks	14@44.1/48 kHz 12@96 kHz		
	Maximum simultaneous playback tracks	12		
	Recording format	WAV 44.1/48/96 kHz, 16/24-bit, mono/stereo WAV format		
	Recording media	16 MB–2 GB SD cards, 4 GB–32 GB SDHC cards, 64 GB–512 GB SDXC cards		
Audio interface	44.1/48 kHz	Recording: 14 channels Playback: 4 channels		
	Bit depth	24-bit		
	Interface	USB2.0		
Card reader	Class	Mass storage USB 2.0 High Speed		
USB HOST	Class	USB2.0 High Speed		
Sampling rate		44.1/48/96 kHz		
Frequency characteristics		Frequency characteristics (44.1 kHz): -1.0 dB: 20 Hz – 20 kHz Frequency characteristics (96 kHz): -3.0 dB: 20 Hz – 40 kHz		
Equivalent input noise		Actual measurements: -128 dB EIN (IHF-A) with +60 dB/150 Ω input		
Display		LCD with backlight (128x64 resolution)		
Power supply		AD-19 AC adapter (DC12 V/2 A)		
Power consumption		17 W maximum		
External dimensions		445 mm (W)x282 mm (D)x70.5 mm (H)		
Weight (main unit only)		2.53 kg		

Send effects specifications

No	Type	Explanation	Parameters 1	Parameters 2	tempo synchronization
1	Hall 1	Hall reverb with a bright tone	TONE	DECAY	
2	Hall 2	Hall reverb with a long time for early reflections	TONE	DECAY	
3	Room 1	Room reverb with coarse reflections	TONE	DECAY	
4	Room 2	Dense room reverb	TONE	DECAY	
5	Plate	Plate reverb simulation	TONE	DECAY	
6	Church	Reverb that simulates the sound of a church	TONE	DECAY	
7	DrumAmb	Reverb that adds a natural ambience (air sound) to drums	TONE	DECAY	
8	GateRev	Special reverb suited to percussive performances	TONE	DECAY	
9	Spring	Spring reverb simulation	TONE	DECAY	
10	Delay	Digital delay with a clear tone	TIME	FEEDBACK	●
11	Analog	Warm analog delay simulation	TIME	FEEDBACK	●
12	P-P Dly	Effect that outputs delay sound alternately left and right	TIME	FEEDBACK	●
13	Vocal 1	Very useful effect that combines delay with hall reverb	TIME	DECAY	
14	Vocal 2	Effect that combines delay with mono output reverb	TIME	DECAY	
15	Vocal 3	Effect that combines delay suitable for ballads with plate reverb	TIME	DECAY	
16	Vocal 4	Effect that combines delay suitable for rock with room reverb	TIME	DECAY	

Note: Delay effects that are tempo synchronized can be synchronized to the project tempo.

To synchronize them, press the TEMPO button and set the tempo. Quarter notes will be synchronized to the tempo.

Mixer block diagram

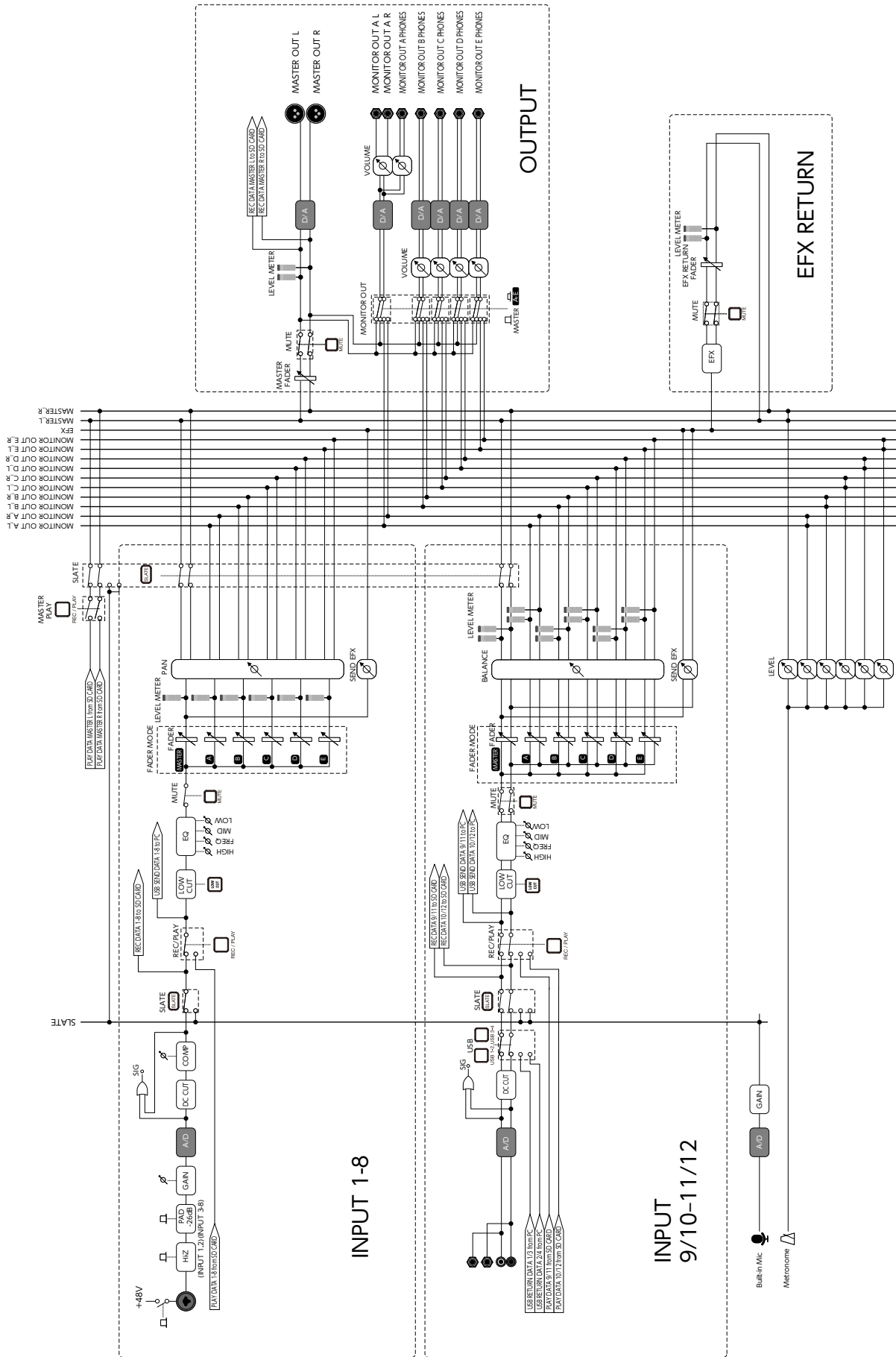



4-4-3 Kanda-surugadai, Chiyoda-ku, Tokyo 101-0062 Japan
<http://www.zoom.co.jp>