

Multi-Effects Processor

G3n/G3Xn

OPERATION MANUAL

Thank you very much for purchasing the **ZOOM G3n/G3Xn**.

Please read this manual carefully to learn about all the functions of the **G3n/G3Xn** so that you will be able to use it fully.

Keep this manual in a convenient place for reference when necessary.



Contents

Usage and safety precautions	2	Using the tuner	28
Introduction	3	Using rhythms	34
Terms used in this manual	3	Using the looper	36
Part names	4	Using the pedal.....	41
Turning the power on	6	Using the tap tempo function	44
Display information	7	Restoring default settings and patches.....	46
Adjusting effects	8	Updating the firmware.....	47
Using patches	16	Troubleshooting	49
Adjusting the master level	22	Rhythm List	50
Changing various settings	23	Specifications	51



Usage and safety precautions

Safety Precautions

In this manual, symbols are used to highlight warnings and cautions that you must read to prevent accidents. The meanings of these symbols are as follows:



	Warning	Something that could cause serious injury or death.
	Caution	Something that could cause injury or damage to the equipment.

Other symbols

	Required (mandatory) actions
	Prohibited actions

Warning

Operation using an AC adapter



-  Use only a ZOOM AD-16 AC adapter with this unit.
-  Do not do anything that could exceed the ratings of outlets and other electrical wiring equipment.

Alterations





-  Never open the case or attempt to modify the product.

Precautions



Product handling

-  Do not drop, bump or apply excessive force to the unit.
-  Be careful not to allow foreign objects or liquids to enter the unit.



Operating environment

-  Do not use in extremely high or low temperatures.
-  Do not use near heaters, stoves and other heat sources.
-  Do not use in very high humidity or near splashing water.
-  Do not use in places with excessive vibrations.
-  Do not use in places with excessive dust or sand.

AC adapter handling

-  When disconnecting the AC adapter from an outlet, always pull the body of the adapter itself.
-  During lightning storms or when not using the unit, disconnect the power plug from the AC outlet.

Connecting cables with input and output jacks

-  Always turn the power OFF for all equipment before connecting any cables.
-  Always disconnect all connection cables and the AC adapter before moving the unit.

Volume

-  Do not use the product at a loud volume for a long period of time.

Usage Precautions

Interference with other electrical equipment

In consideration of safety, the **G3n/G3Xn** has been designed to minimize the emission of electromagnetic radiation from the device and to minimize external electromagnetic interference. However, equipment that is very susceptible to interference or that emits powerful electromagnetic waves could result in interference if placed nearby. If this occurs, place the **G3n/G3Xn** and the other device farther apart.

With any type of electronic device that uses digital control, including the **G3n/G3Xn**, electromagnetic interference could cause malfunction, corrupt or destroy data and result in other unexpected trouble. Always use caution.

Cleaning

Use a soft cloth to clean the panels of the unit if they become dirty. If necessary, use a damp cloth that has been wrung out well. Never use abrasive cleansers, wax or solvents, including alcohol, benzene and paint thinner.

Malfunction

If the unit becomes broken or malfunctions, immediately disconnect the AC adapter, turn the power OFF and disconnect other cables. Contact the store where you bought the unit or ZOOM service with the following information: product model, serial number and specific symptoms of failure or malfunction, along with your name, address and telephone number.

Copyrights

- Windows®, Windows 7® Windows 8.1® and Windows® 10 are trademarks or registered trademarks of Microsoft®.
- Macintosh® and Mac OS® are trademarks or registered trademarks of Apple Inc.
- All other trademarks, product names and company names mentioned in this documentation are the property of their respective owners.

Note: All trademarks and registered trademarks mentioned in this manual are for identification purposes only and are not intended to infringe on the copyrights of their respective owners.

FCC regulation warning (for U.S.A.)

Note: This equipment has been tested and found to comply with the limits for a Class B digital device, pursuant to Part 15 of the FCC Rules. These limits are designed to provide reasonable protection against harmful interference in a residential installation. This equipment generates, uses and can radiate radio frequency energy and, if not installed and used in accordance with the instructions, may cause harmful interference to radio communications. However, there is no guarantee that interference will not occur in a particular installation. If this equipment does cause harmful interference to radio or television reception, which can be determined by turning the equipment off and on, the user is encouraged to try to correct the interference by one or more of the following measures:

- Reorient or relocate the receiving antenna.
- Increase the separation between the equipment and receiver.
- Connect the equipment into an outlet on a circuit different from that to which the receiver is connected.
- Consult the dealer or an experienced radio/TV technician for help.

For EU Countries

 Declaration of Conformity

Introduction

More advanced user interface

We have made the stompbox-style user interface developed for our G series even more advanced. Using the three displays, you can easily check effect parameters and effect chains.

Detailed emulations of amp and cabinet characteristics

The **G3n/G3Xn** delivers studio-quality sound with precise emulations of circuit operations and tube amp characteristics along with cabinets modeled using impulse responses.

Download new effects and patches

Our free **G3n/G3Xn** Effects/Patch Manager software for Windows and MacOS allows you to regularly download new effects and patches created by ZOOM. For detailed information, see the ZOOM website (<http://www.zoom.co.jp/downloads/>).

Terms used in this manual

Patch

The **G3n/G3Xn** can store up to 150 patches with effect parameter settings and ON/OFF states.

Bank

A set of three patches is called a "bank".

Unit

Each "Unit" combines a Display, 4 parameter knobs and a foot switch.

Large effect

An effect that uses multiple units is called a "large effect".

* A printed list of effect parameters is not included with the **G3n/G3Xn**.
Please download a copy from the ZOOM website. → <http://www.zoom.co.jp/>

Part names

Front panel

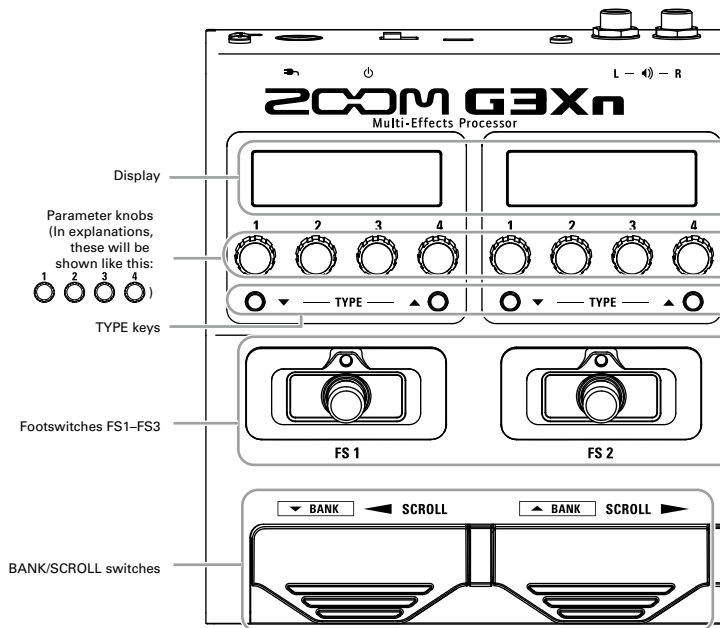

Rear panel

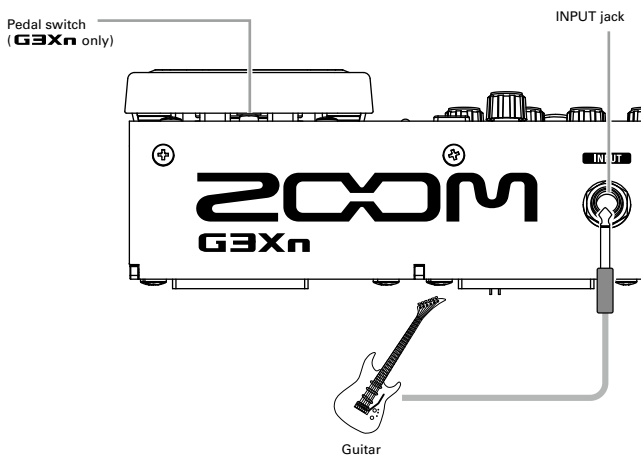

Part names

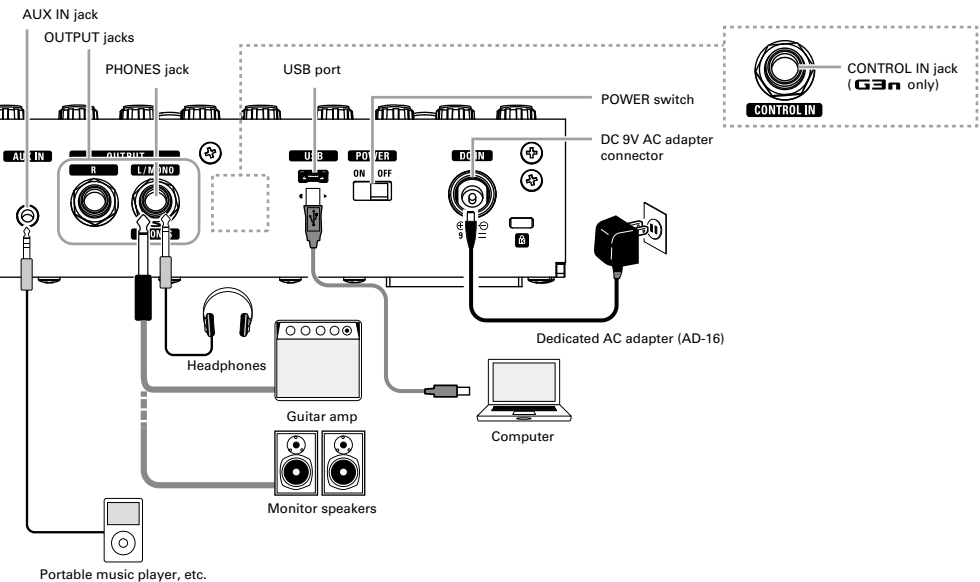
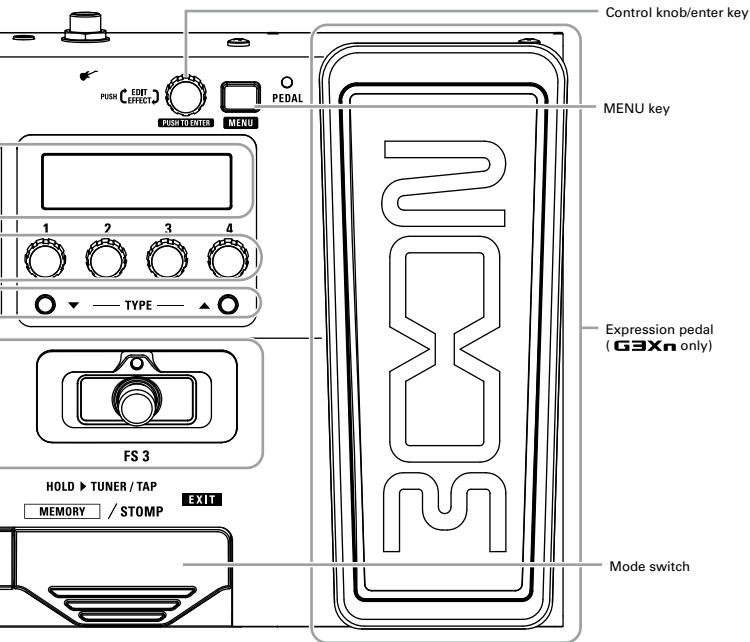

Turning the power on

To turn the power on

- Lower the amplifier's volume all the way.



- Connect the AC adapter before setting the POWER switch to ON.

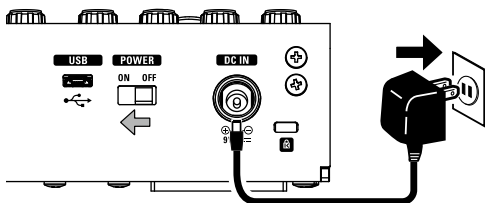

- Turn the power of your guitar amplifier or PA system on and raise its volume.

HINT

The **G3n/G3Xn** starts up in the mode used when the POWER switch was last turned OFF.

Using the eco setting

When eco mode is ON, the **G3n/G3Xn** will automatically turn off if it is not used for 10 hours.

Display information

Display in STOMP mode

In STOMP mode, you can turn effects ON/OFF and change effect types.

Standard effect

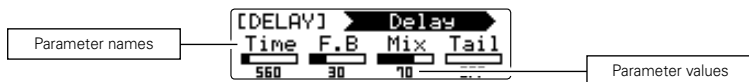

Large effect



Switching display contents

Press **PUSH**  to switch between showing parameters and effect names.



Display in MEMORY mode

In MEMORY mode, you can change patches and banks.



Showing the effects used in a patch

Press  to show the effects used in a patch.

When the effects are shown, turn  to scroll through the effects.



Press  again to return to the original screen.

Adjusting effects

Press **MEMORY** / **STOMP**  to change to STOMP mode.

Turning effects ON/OFF

- Press .
- This turns that effect ON/OFF.



NOTE

Some large effects have SOLO or other special functions assigned to .

The parameter function assigned to  is shown on the Display with white letters on a dark background.

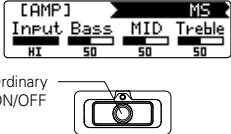

Ordinary ON/OFF

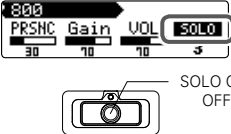

SOLO ON/OFF

Selecting effect types

- Press  **TYPE** .
- This changes the effect type.



NOTE

The **G3n/G3Xn** allows you to combine up to 7 effects in whatever order you like. If limits on the processing capability or the number of units used are exceeded, a "PROCESS OVERFLOW" warning will appear and effects will be bypassed. To end bypassing, delete some effects or change their types.



Selecting effect categories

- While pressing and holding **TYPE ▲** , press **TYPE ▼** .



- The category name will appear and the effect will be changed to the first effect type in the category.







HINT

While pressing and holding **TYPE ▼** , press **TYPE ▲**  to change effect categories in reverse order.



Adjusting effects

Adjusting parameters

- Turn , ,  and .

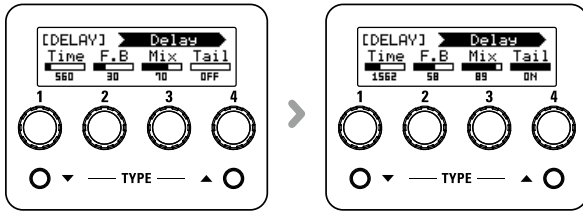

HINT

- Parameter adjustments are saved automatically.
- When AUTO SAVE is set to OFF, a parameter saving screen will appear when you try to change patches. (→P19)

NOTE

Set Time, Rate and other effect parameters to musical notes to sync them to the tempo. (→P44)

Scrolling effect displays

- Use  and  to scroll the screen.

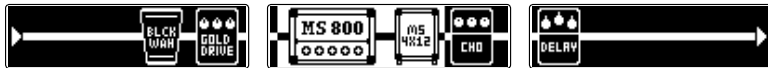

- Press  or .



- Press repeatedly to scroll the effect displays.

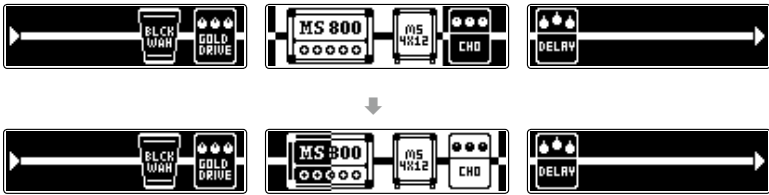

- Press  .

Adding effects

- Press  to open the MENU screen.



- Turn  to select ADD.



NOTE

If 7 effects are already in use, ADD will not be shown.



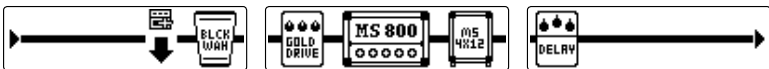

- Press  to open the ADD screen.

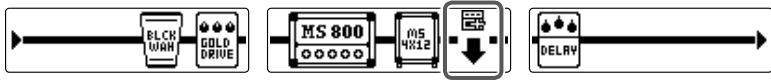

Adjusting effects

- Turn  to select where the effect will be added.



- Press  to confirm where the effect is added.



- A cable will be added to the Display.



- Press  **TYPE**  to select the effect type.





Deleting effects

- Press  to open the MENU screen.

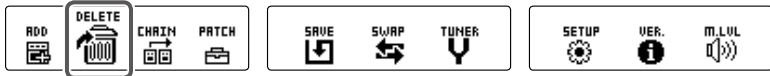

- Turn  to select DELETE.



- Press  to open the DELETE screen.

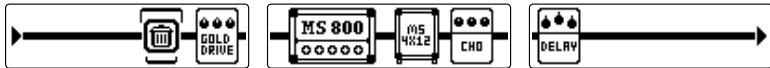

- Turn  to select the effect to delete.

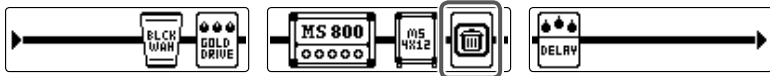

- Press .



- Press  to delete the effect.

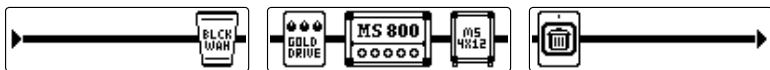

HINT

- Turn  to cancel deletion.



Adjusting effects

- Press .

Changing the effect order

- Press  to open the MENU screen.



- Turn  to select CHAIN.



- Press  to open the CHAIN screen.

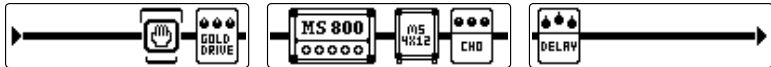

- Turn  to select the effect to swap.

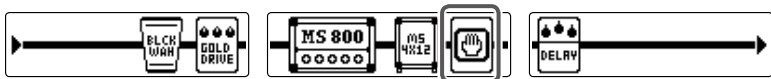

- Press  to confirm the effect to swap.

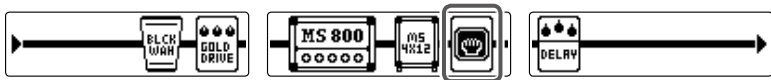

- Turn  to swap with the next effect in the chain.

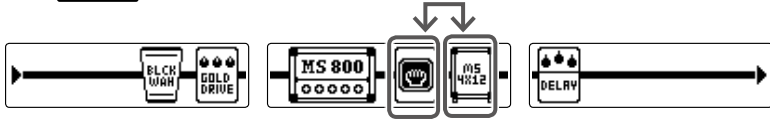

- Press .

Using amp effects

The amp effects in the **G3n/G3Xn** can provide optimal sounds when combined with cabinet effects.

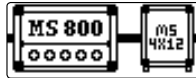

Change the MIC parameter of the cabinet effect according to the device connected.

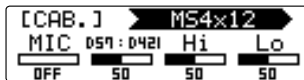

For guitar amp output :
MIC parameter OFF

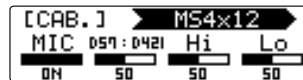



For output from headphones or
monitor speakers :
MIC parameter ON

Using patches

Press  to switch to MEMORY mode.

Selecting patches

■ Switching patches

- Press  ,  or .



- This changes the patch.

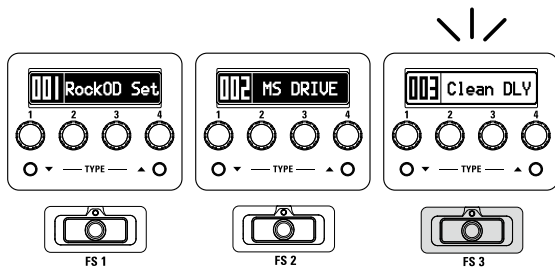

NOTE

The selected patch has a white background.

■ Switching banks



- Use  and .



- This changes the bank.



NOTE

- Press and hold  ,  to change banks continuously.
- See P24 for information about the preselect function that enables changing to banks with distant numbers.

Setting independent patch parameters

■ Entering patch setting mode

- Press  to open the MENU screen.



- Turn  to select PATCH.



- Press  to open the PATCH screen.



■ Adjusting patch levels

- Turn  to select LEVEL.

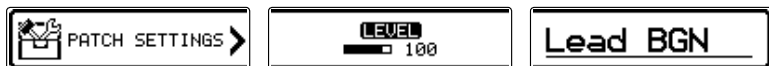

- Press .



- Turn  to set the patch level.



Using patches

NOTE

The setting range is 0–120.



- Press  to confirm the patch level.



■ Changing patch names

- Turn  to select the character to change.



- Press  to confirm the character to change.



- Turn  to change the character.



- Press  to confirm the changed character.

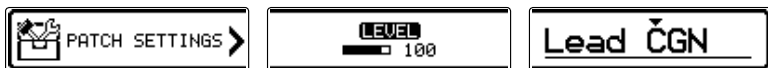

NOTE

- The characters and symbols that can be used are as follows.
! # \$ % & ^ ' () + , - . : = @ [] ^ _ ` { } ~, (space) A–Z, a–z, 0–9
- Press and hold  to change the character type.

■ Ending patch setting mode

- Press .

Saving patches

- Press  to open the MENU screen.



- Turn  to select SAVE.



- Press  to open the SAVE screen.

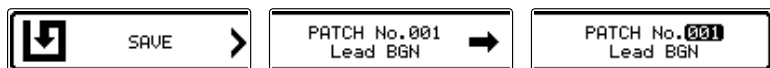

- Turn  to select where the patch will be saved.

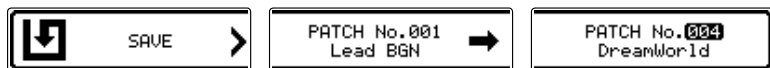

- Press  to confirm where the patch will be saved.

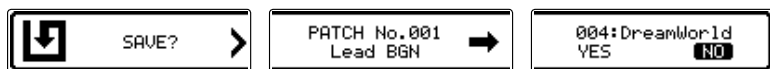

- Turn  to select YES.

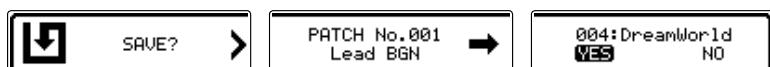

Using patches

HINT

Select NO to cancel saving the patch.

- Press  to save the patch.

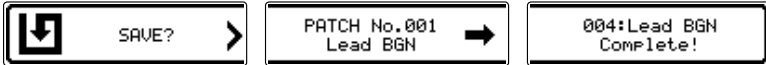

Swapping patches

- Press  to open the MENU screen.

- Turn  to select SWAP.



- Press  to open the SWAP screen.

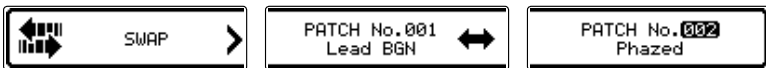

- Turn  to select the patch to be swapped.

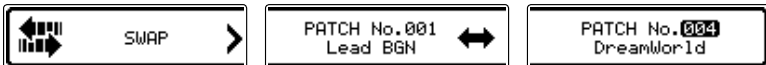

- Press  to confirm the patch to be swapped.

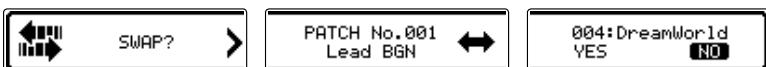

- Turn  to select YES.



HINT

Select NO to cancel swapping.



- Press  to swap the patches.

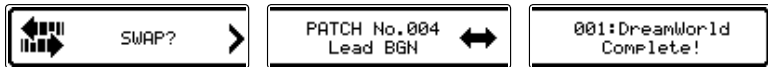



Adjusting the master level

- Press  to open the MENU screen.

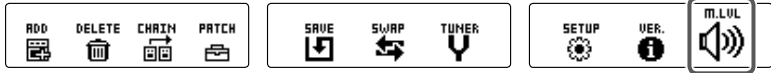

- Turn  to select M.LVL.



- Press  to open the MASTER LEVEL screen.



- Turn  to adjust the master level.



NOTE

The setting range is 0–120.

HINT

You can also turn  to adjust the master level in both STOMP and MEMORY modes.

Changing various settings

Change various settings on the SETUP screen.

Opening the SETUP screen

- Press  to open the MENU screen.



- Turn  to select SETUP.



- Press  to open the SETUP screen.



Changing various settings

Setting the preselect function

Turn PRESELECT ON to enter standby when the bank is switched, allowing you to press a foot switch to confirm the patch change.

- On the SETUP screen, turn  to select PRESELECT.



- Press .



- Turn  to set PRESELECT to ON/OFF.



- Press  to confirm the preselect setting.



Setting the eco mode

When eco mode is on, the **G3n/G3Xn** will automatically turn off if not used for 10 hours.

- On the SETUP screen, turn  to select eco.



- Press .



- Turn  to set eco to ON/OFF.



- Press  to confirm the eco mode setting.



Changing various settings

Setting the auto save function

Enable parameters to be saved automatically.

- On the SETUP screen, turn  to select AUTO SAVE.

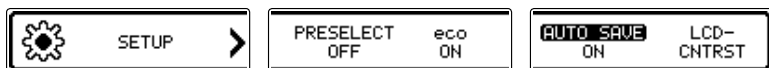

- Press .



- Turn  to set AUTO SAVE to ON/OFF.

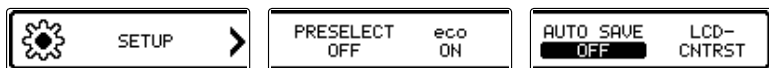

NOTE

When set to OFF, no patch or effect parameters will be saved automatically.



- Press  to confirm the auto save setting.



Note about switching patches

When AUTO SAVE is set to OFF, if you try to switch patches after changing any parameters, a message will appear asking to save the parameter changes.

To save changes to parameters before switching patches, select YES. (→P19)

To discard changes to parameters before switching patches, select NO.

Adjusting the display contrast

- On the SETUP screen, turn  to select LCD CNTRST.



- Press .

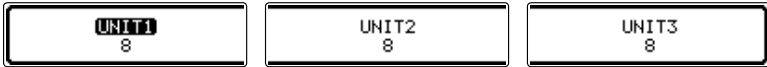

- Turn  to select a display to adjust its contrast.

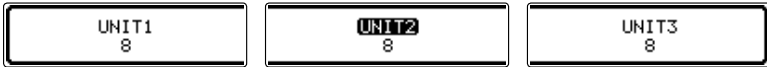

- Press  to confirm the display.

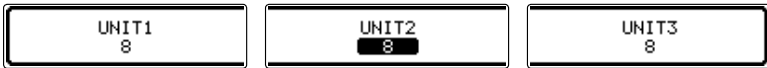

- Turn  to adjust the contrast.



NOTE

The setting range is 1–13.



- Press  to confirm the contrast setting.

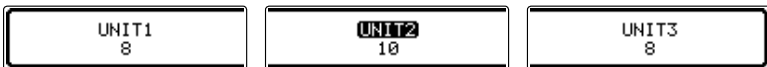



Using the tuner

Activating the tuner

- Press and hold  in STOMP or MEMORY mode.



- Press  or .



The BYPASS sound is output when the TUNER is active.



No sound is output when the TUNER is active.



- This opens the TUNER screen.



Tuning a guitar

- Play the open string that you want to tune and adjust its pitch.

Chromatic tuner

The name of the nearest note and the pitch accuracy are shown.



Other tuners

The number of the nearest string and the pitch accuracy are shown.

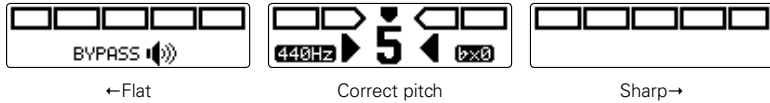

Closing the tuner

- Press  when the TUNER screen is open.

Using the tuner

Changing the tuner settings

■ Opening the TUNER SETTINGS screen

- Press  to open the MENU screen.



- Turn  to select TUNER.

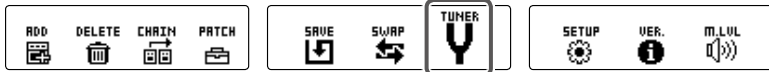

- Press  to open the TUNER SETTINGS screen.



■ Changing the standard pitch of the tuner

- On the TUNER SETTINGS screen, turn  to select CALIBRATION.



- Press .



- Turn  to change the standard pitch.



NOTE

The setting range is 435–445 Hz for middle A.



- Press  to confirm the standard pitch of the tuner.



HINT

You can also turn the center unit  when the TUNER screen is open to change the standard pitch.

Using the tuner

■ Changing the tuner type

- On the TUNER SETTINGS screen, turn  to select TYPE.



- Press .

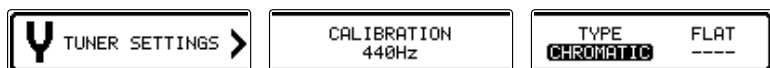

- Turn  to select the tuner type.

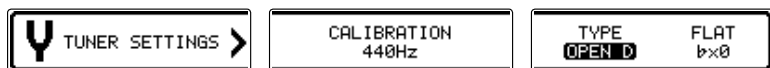

CHROMATIC

The chromatic tuner shows the nearest pitch name (semitone) and how far the input sound is from that pitch.

Other tuner types

Depending on the selected type, the nearest string name and how far the sound input is from that pitch are shown. The following tuner types can be selected.

Display	Meaning	String number/Note name						
		7	6	5	4	3	2	1
GUITAR	Standard tuning for guitars, including 7-string guitars	B	E	A	D	G	B	E
OPEN A	In open A tuning, the open strings make an A chord	-	E	A	E	A	C#	E
OPEN D	In open D tuning, the open strings make a D chord	-	D	A	D	F#	A	D
OPEN E	In open E tuning, the open strings make an E chord	-	E	B	E	G#	B	E
OPEN G	In open G tuning, the open strings make a G chord	-	D	G	D	G	B	D
DADGAD	This alternate tuning is often used for tapping, etc.	-	D	A	D	G	A	D



- Press  to confirm the tuner type.

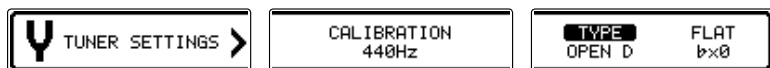

■ Using flat tuning

- On the TUNER SETTINGS screen, turn  to select FLAT.
 PUSH TO ENTER



- Press .
 PUSH TO ENTER



- Turn  to change the flat tuning.
 PUSH TO ENTER



NOTE

- You can drop the tuning by one (x 1), two (x 2) or three (x 3) semitones.
- Drop tuning is not possible when the TYPE is set to CHROMATIC.



- Press  to confirm the flat tuning setting.
 PUSH TO ENTER



Using rhythms

Selecting a rhythm

- Press  to change to STOMP mode.



- Use  **TYPE**  to select RHYTHM for the desired unit.

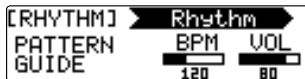

NOTE

One RHYTHM can be selected per patch.

Playing a rhythm

- Press  for the unit using the rhythm effect.



- The rhythm starts playing.

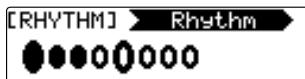

HINT

- During rhythm playback, you can switch between STOMP and MEMORY modes.
- If you change a patch during rhythm playback, the rhythm will stop.

Stopping a rhythm

- During rhythm playback, press  for the unit using the rhythm.



- The rhythm stops.

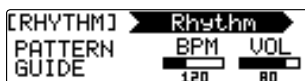

Setting rhythms

■ Selecting rhythm patterns

- Turn  for the unit using the rhythm.



NOTE

See P50 for information about the patterns.

■ Adjusting the rhythm tempo

- Turn  for the unit using the rhythm.



NOTE

- The setting range is 40–250 bpm.
- This tempo setting is used by every effect, rhythms and the looper.

■ Adjusting the rhythm volume

- Turn  for the unit using the rhythm.



NOTE



The setting range is 0–100.

Using the looper

Selecting the looper

- Press  to change to STOMP mode.



- Use  **TYPE**  to select a LOOPER for the desired unit.

1-unit looper

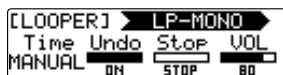

2-unit looper

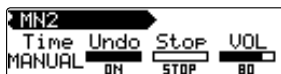

NOTE

- There are 4 types of loopers: 1-unit mono, 2-unit mono, 1-unit stereo and 2-unit stereo.
- One LOOPER can be selected per patch.

Recording, playing and clearing phrases

■ Recording phrases

- Press  for the first unit in the LOOPER.



- This starts recording.



- Recording stops and loop playback starts.

If the recording time is set to "MANUAL"

Loop playback will start when you press  again or when the maximum recording time is reached.

If the recording time is set to a musical note

Loop playback will start when the set recording time is reached.



HINT

- See P39 for how to set the LOOPER recording time.
- During phrase recording and playback, switching to MEMORY mode will not interrupt it.

NOTE

- During rhythm playback, recording will start after the precount.
- Changing a patch will stop phrase recording and playback. Moreover, this will delete the phrase recording data.
- During rhythm playback, quantization is enabled so even if the recording ending time is not exact, the loop will automatically be adjusted so that loop playback stays in time.
- Changing the tempo of a RHYTHM during loop playback will erase the recorded phrase.

■ Overdubbing a recorded phrase

- During loop playback, press  for the first unit in the LOOPER.



■ Stopping loop playback

With 1-unit looper

- During loop playback, press  twice for the unit using the looper.



- This stops the playback.



Using the looper

With 2-unit looper

- During loop playback, press  for the second unit in the LOOPER.



- This stops the playback.



■ Deleting phrases

With 1-unit looper

- When loop playback is stopped, press and hold  for the unit using the looper.



- This deletes the phrase.



With 2-unit looper

- When loop playback is stopped, press  for the second unit in the LOOPER.



- This deletes the phrase.

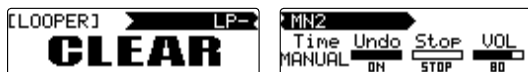

Setting the looper

■ Setting the looper recording time

- Turn  for the unit using the looper.



NOTE

- The setting options include MANUAL and 1–64 quarter notes.
- The recording time for the mono looper is from 1.5 to 80 seconds (40 seconds when UNDO is ON).
- The recording time for the stereo looper is from 1.5 to 40 seconds (20 seconds when UNDO is ON).
- Settings that will not fit in the recording time will be adjusted automatically.
- Changing the recording time will delete the recorded data.

■ Setting the UNDO function

- Turn  for the unit using the looper to set it to ON/OFF.



NOTE



When UNDO is ON, the recording time will become as follows.

- Mono looper: 40 seconds
- Stereo looper: 20 seconds



Using the UNDO and REDO functions

If UNDO is ON, you can undo the last overdub. You can also use the REDO function to restore the phrase that the UNDO function deleted.

With 1-unit looper

To undo an overdub, press  for one second during playback. To restore the deleted phrase, press  for one second again.

With 2-unit looper

To undo an overdub, press  for the first unit twice during playback. To restore the deleted phrase, press  twice again.

Using the looper

■ Setting how loop playback stops

- Turn  for the unit using the looper.

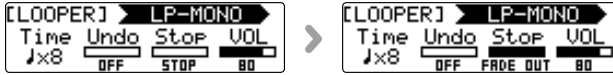

STOP

Stop playback immediately.

FINISH

Play to the end and then stop.

FADE OUT

Stop after fading out.

■ Adjusting the looper volume

- Turn  for the unit using the looper.



NOTE

The setting range is 0-100.

Using the pedal

Using a connected pedal (G3n only)

■ Setting up the connected pedal

You can set a pedal effect to be assigned to the connected pedal.

- Press  to open the MENU screen.



- Turn  to select EX PDL.

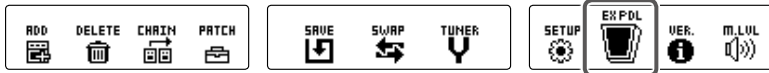

- Press  to open the EXT PEDAL screen.



- Turn  to turn the connected pedal ON/OFF.



HINT

When EXT PEDAL is ON, you can use a pedal effect.



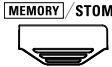

Using the pedal

Using the G3Xn pedal

■ Selecting the pedal effect





- Press  to change to STOMP mode.

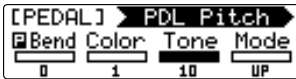

- Press   TYPE   to select the pedal effect.



NOTE

To select the PEDAL category, press TYPE ▲  while pressing TYPE ▼  or press TYPE ▼  while pressing TYPE ▲ .





- Press  down.

HINT

- Press the front-end of the expression pedal down to turn the pedal effect ON/OFF. This does not, however, change the ON/OFF setting.
- You can also press  to turn the pedal effect ON/OFF. This does change the ON/OFF setting.

Calibrating the G3Xn pedal

■ Calibrating the sensitivity

- Turn the power switch ON while pressing .
- Operate the pedal as instructed on the display, and press  when required.

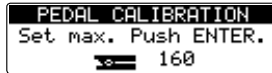
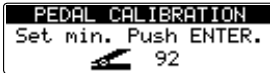

- "Complete!" will appear before play mode becomes active.



NOTE

- Calibrate in the following cases.
- Stepping on the pedal has little effect.
 - The volume and tone changes greatly even when the pedal is only pressed lightly.

■ Adjusting the torque

- Insert the hex key into the torque adjustment screw on the side of the pedal. Turn it clockwise to tighten the pedal, and turn it counterclockwise to loosen the pedal.

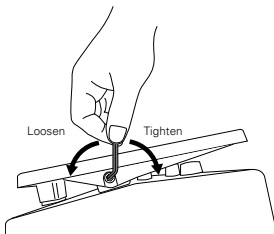

NOTE

- Be careful when loosening a torque adjustment screw, because if you loosen it too much, it could come off inside the unit, making it impossible to hold the pedal in place.

Using the tap tempo function

Loopers, rhythms, delays and some modulation effects can be synchronized to the tempo.

To synchronize, first select an effect that has a parameter that can be synchronized and set that parameter (Time or Rate, for example) to a note value (♩ or ♪).

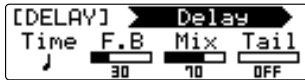

Enabling tap tempo

- Press and hold  in STOMP or MEMORY mode.



- Press  to open the TAPTEMPO screen.

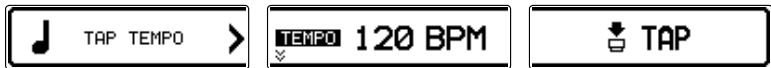

Setting the tempo

- Press  at least twice at the desired tempo.

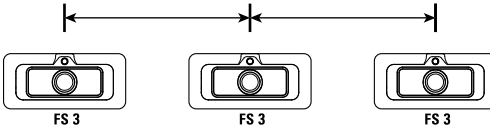

- ▼
- This sets the tempo.

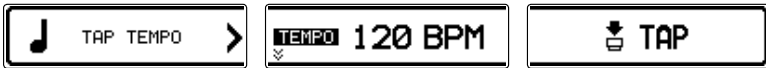

HINT

You can also turn  for the center unit to adjust the tempo.

Ending tap tempo setting

- Press  when the TAP TEMPO screen is open.

Restoring default settings and patches

- While pressing  , set the POWER switch to ON.



- Turn  to select YES.



HINT

Select NO to cancel initialization.



- Press  to initialize.



- "Complete!" will appear on the display when initializing completes.



HINT

Executing the All Initialize function will restore all the settings of the **G3n/G3Xn**, including its patches, to factory defaults. Do not use this function unless you are certain that you want to do this.

Updating the firmware

Checking the firmware version

- Press  to open the MENU screen.



- Turn  to select VER.



- Press  and check the version.

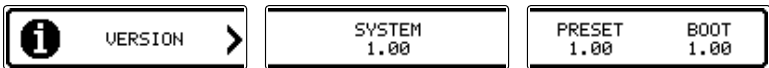

Updating the firmware

Updating the firmware

■ To download the latest firmware

Visit the ZOOM Website (<http://www.zoom.co.jp/>).

- Connect the **G3n/G3Xn** to a computer using a USB cable.

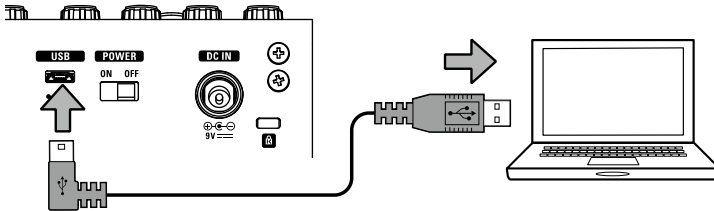

- While pressing both  and , set the POWER switch to ON.

- Launch the version update application on your computer, and execute the update.



NOTE

Do not disconnect the USB cable during the update.

HINT

See the ZOOM website for instructions about how to use the application.

- "Complete!" will appear on the display when updating completes.

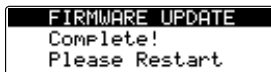

- Set the POWER switch to OFF.

HINT

Updating the firmware version will not erase saved patches.

Troubleshooting

No sound or very low volume

- Confirm that the POWER switch is set to "ON".
- Check the connections (→P4–5).
- Adjust the patch level (→P17).
- Adjust the master level (→P22).
- If you are using the expression pedal to adjust the volume, adjust the pedal position until the volume level is suitable.

There is a lot of noise

- Check shielded cables for defects.
- Use only a genuine ZOOM AC adapter.

An effect is not working

- If limits on effect processing capacity, the number of units or the amount of resources used are exceeded, effects will be bypassed and the following message will appear (→P9).

PROCESS OVERFLOW

Expression pedal does not work well

- Confirm the setting of the connected pedal (→P41).
- Select the pedal effect (→P42).
- Adjust the pedal (→P43).

Rhythm List

No.	PatternName	TimSig
1	GUIDE	4/4
2	8Beats1	4/4
3	8Beats2	4/4
4	8Beats3	4/4
5	16Beats1	4/4
6	16Beats2	4/4
7	16Beats3	4/4
8	Rock1	4/4
9	Rock2	4/4
10	Rock3	4/4
11	ROCKABLY	4/4
12	R'n'R	4/4
13	HardRock	4/4
14	HeavyMtl	4/4
15	MtlCore	4/4
16	Punk	4/4
17	FastPunk	4/4
18	Emo	4/4
19	TomTomBt	4/4
20	Funk1	4/4
21	Funk2	4/4
22	FunkRock	4/4
23	JazzFunk	4/4

No.	PatternName	TimSig
24	R&B1	4/4
25	R&B2	4/4
26	70s Soul	4/4
27	90s Soul	4/4
28	Motown	4/4
29	HipHop	4/4
30	Disco	4/4
31	Pop	4/4
32	PopRock	4/4
33	IndiePop	4/4
34	EuroPop	4/4
35	NewWave	4/4
36	OneDrop	4/4
37	Steppers	4/4
38	Rockers	4/4
39	Ska	4/4
40	2nd Line	4/4
41	Country	4/4
42	Shuffle1	4/4
43	Shuffle2	4/4
44	Blues1	4/4
45	Blues2	4/4
46	Jazz1	4/4

No.	PatternName	TimSig
47	Jazz2	4/4
48	Fusion	4/4
49	Swing1	4/4
50	Swing2	4/4
51	Bossa1	4/4
52	Bossa2	4/4
53	Samba1	4/4
54	Samba2	4/4
55	Breaks1	4/4
56	Breaks2	4/4
57	Breaks3	4/4
58	12/8 Grv	12/8
59	Waltz	3/4
60	JzWaltz1	3/4
61	JzWaltz2	3/4
62	CtWaltz1	3/4
63	CtWaltz2	3/4
64	5/4 Grv	5/4
65	Metro3	3/4
66	Metro4	4/4
67	Metro5	5/4
68	Metro	

Specifications

Effect types	80 types
Number of simultaneous effects	7
Number of user patches	150
Sampling frequency	44.1 kHz
A/D conversion	24-bit with 128x oversampling
D/A conversion	24-bit with 128x oversampling
Signal processing	32-bit
Frequency characteristics	20-20 kHz +1 dB, -3 dB (10 kΩ load)
Display	128×32 dot-matrix LCDs (3)
Input INPUT	Standard monaural phone jack Rated input level: -20 dBu Input impedance(line) : 470 kΩ
AUX IN	Stereo mini jack Rated input level: -10 dBu Input impedance(line) : 10 kΩ
Output R	Standard monaural phone jack Maximum output level: +5 dBm (with output load impedance of 10 kΩ or more)
L/MONO/PHONES	Standard stereo phone jack (combined line/headphone) Maximum output level: Line +5 dBm (with output load impedance of 10 kΩ or more) Headphones 15 mW +15 mW (into 32 Ω load)
Equivalent input noise	119 dBu
Noise floor (residual noise)	-100 dBu
Control input	FP02 input (G3n only)
Power	AC adapter DC9V (center minus plug), 500 mA (ZOOM AD-16)
Dimensions	G3n 181 mm(D) X 234 mm(W) X 58 mm(H) G3Xn 181 mm(D) X 318 mm(W) X 64 mm(H)
USB	USB MIDI USB Micro-B
Weight	G3n 1.28 kg G3Xn 1.84 kg
Options	FP02 expression pedal (G3n only)

• 0 dBm=0.775 Vrms

zoom[®]

ZOOM CORPORATION

4-4-3 Kandasurugadai, Chiyoda-ku, Tokyo 101-0062 Japan

<http://www.zoom.co.jp>